

ABB industrial drives

Firmware manual ACS880-M04 machinery control program



List of related manuals

Drive hardware manuals

Code (English)

<i>ACS880-M04 drives hardware manual</i>	3AXD50000028613
<i>*ACS880-01 drives hardware manual</i>	3AUA0000078093
<i>*ACS880-04 drive modules (200 to 710 kW, 300 to 700 hp) hardware manual</i>	3AUA0000128301

Drive firmware manuals and guides

<i>Adaptive programming application guide</i>	3AXD50000028574
<i>Drive (IEC 61131-3) application programming manual</i>	3AUA0000127808

Option manuals and guides

<i>ACS880-M04 Quick installation guide</i>	3AXD50000032345
<i>ACX-AP-x Assistant control panels user's manual</i>	3AUA0000085685
<i>ACS-BP-S Basic control panels user's manual</i>	3AXD50000032527
<i>Drive composer Start-up and maintenance PC tool User's manual</i>	3AUA0000094606

Manuals and quick guides for I/O extension modules, fieldbus adapters, encoder interfaces, etc.

You can find manuals and other product documents in PDF format on the Internet. See section [Document library on the Internet](#) on the inside of the back cover. For manuals not available in the Document library, contact your local ABB representative.

*A list of links to all manuals applicable to this product is available in the Document library:

Firmware manual

ACS880-M04 machinery control program

Table of contents



Table of contents

List of related manuals	2
-------------------------------	---

1. Introduction to the manual

What this chapter contains	11
Applicability	11
Safety instructions	11
Target audience	11
Contents of the manual	12
Related documents	12
Terms and abbreviations	13

2. Using the control panel

3. Start-up

Contents of this chapter	17
Before you start	17
Safety	17
Start-up	18



4. Control locations and operating modes

What this chapter contains	25
Local control vs. external control	26
Local control	26
External control	27
Operating modes of the drive	28
Speed control mode	29
Torque control mode	29
Frequency control mode	29
Special control modes	29

5. Program features

What this chapter contains	31
Drive configuration and programming	32
Programming via parameters	32
Adaptive programming	33
Application programming	35
Control interfaces	36
Programmable analog inputs	36
Programmable analog outputs	36
Programmable digital inputs and outputs	36
Programmable relay outputs	37
Programmable I/O extensions	37
Fieldbus control	38

6 Table of contents

Master/follower functionality	39
External controller interface	44
Motor control	45
Direct torque control (DTC)	45
Reference ramping	45
Constant speeds/frequencies	46
Critical speeds/frequencies	46
Speed controller autotune	47
Oscillation damping	50
Rush control	51
Encoder support	52
Position counter	54
Jogging	57
Scalar motor control	59
Autophasing	60
Flux braking	63
DC magnetization	64
Application control	67
Application macros	67
Motor potentiometer	67
DC voltage control	68
Overvoltage control	68
Undervoltage control (power loss ride-through)	68
Voltage control and trip limits	70
Brake chopper	70
Safety and protections	72
Emergency stop	72
Motor thermal protection	73
Thermal protection of motor cable	76
Other programmable protection functions	76
Automatic fault resets	78
Diagnostics	79
Fault and warning messages, data logging	79
Signal supervision	79
Maintenance timers and counters	79
Energy saving calculators	80
Load analyzer	80
Miscellaneous	82
User parameter sets	82
Data storage parameters	82
du/dt filter support	83

6. Application macros

What this chapter contains	85
General	85
Factory macro	86
Default parameter settings for the Factory macro	86
Default control connections for the Factory macro	87

7. Parameters

What this chapter contains	89
Terms and abbreviations	90
Summary of parameter groups	91
Parameter listing	94
01 Actual values	94
03 Input references	98
04 Warnings and faults	99
05 Diagnostics	106
06 Control and status words	108
07 System info	120
10 Standard DI, RO	122
11 Standard DIO, FI, FO	130
12 Standard AI	136
13 Standard AO	141
14 I/O extension module 1	147
15 I/O extension module 2	169
19 Operation mode	173
20 Start/stop/direction	176
21 Start/stop mode	188
22 Speed reference selection	198
23 Speed reference ramp	209
24 Speed reference conditioning	217
25 Speed control	220
26 Torque reference chain	234
28 Frequency reference chain	243
30 Limits	255
31 Fault functions	263
32 Supervision	276
33 Generic timer & counter	280
35 Motor thermal protection	290
36 Load analyzer	304
43 Brake chopper	308
44 Mechanical brake control	310
45 Energy efficiency	316
46 Monitoring/scaling settings	320
47 Data storage	324
49 Panel port communication	327
50 Fieldbus adapter (FBA)	330
51 FBA A settings	341
52 FBA A data in	342
53 FBA A data out	343
54 FBA B settings	344
55 FBA B data in	345
56 FBA B data out	346
58 Embedded fieldbus	346
60 DDCS communication	357
61 D2D and DDCS transmit data	366
62 D2D and DDCS receive data	370
90 Feedback selection	379



91 Encoder module settings	391
92 Encoder 1 configuration	395
93 Encoder 2 configuration	403
95 HW configuration	406
96 System	410
97 Motor control	419
98 User motor parameters	423
99 Motor data	425
200 Safety	433

8. Additional parameter data

What this chapter contains	435
Terms and abbreviations	435
Fieldbus addresses	436
Parameter groups 1...9	437
Parameter groups 10...99	442



9. Fault tracing

What this chapter contains	479
Safety	479
Indications	479
Warnings and faults	479
Pure events	480
Editable messages	480
Warning/fault history and analysis	480
Event logs	480
Other data loggers	481
Parameters that contain warning/fault information	481
QR Code generation for mobile service application	482
Warning messages	483
Fault messages	503

10. Fieldbus control through the embedded fieldbus interface (EFB)

What this chapter contains	527
System overview	527
Connecting the fieldbus to the drive	528
Setting up the embedded fieldbus interface	529
Setting the drive control parameters	530
Basics of the embedded fieldbus interface	533
Control word and Status word	534
References	534
Actual values	534
Data input/outputs	534
Register addressing	535
About the control profiles	536
The ABB Drives profile	537
Control Word	537
Status Word	539

State transition diagram	540
References	541
Actual values	542
Modbus holding register addresses	543
The Transparent profile	544
Modbus function codes	545
Exception codes	546
Coils (0xxxx reference set)	547
Discrete inputs (1xxxx reference set)	548
Error code registers (holding registers 400090...400100)	550

11. Fieldbus control through a fieldbus adapter

What this chapter contains	551
System overview	551
Basics of the fieldbus control interface	554
Control word and Status word	555
References	556
Actual values	557
Contents of the fieldbus Control word	558
Contents of the fieldbus Status word	559
The state diagram	560
Setting up the drive for fieldbus control	561
Parameter setting example: FPBA (PROFIBUS DP)	562

12. Control chain diagrams

What this chapter contains	565
Speed reference source selection I	566
Speed reference source selection II	567
Speed reference ramping and shaping	568
Motor feedback configuration	569
Load feedback and position counter configuration	570
Speed error calculation	571
Speed controller	572
Torque reference source selection and modification	573
Operating mode selection	574
Reference selection for torque controller	575
Torque limitation	576
Torque controller	577
Frequency reference selection	578
Frequency reference modification	579
Master/Follower communication I (Master)	580
Master/Follower communication II (Follower)	581

Further information

Product and service inquiries	583
Product training	583
Providing feedback on ABB Drives manuals	583
Document library on the Internet	583







Introduction to the manual

What this chapter contains

This chapter describes the contents of the manual. It also contains information on the compatibility, safety and intended audience.

Applicability

This manual applies to ACS880-M04 machinery control program version 2.4x.

The firmware version of the control program is visible in parameter [07.05 Firmware version](#), or the **System info** in the main menu on the drive control panel.

Safety instructions

Obey all safety instructions delivered with the drive.

- Read the **complete safety instructions** before you install, commission, or use the drive. The complete safety instructions are delivered with the drive as part of the *Hardware manual* as a separate document.
- Read the **firmware function-specific warnings and notes** before changing parameter values. These warnings and notes are included in the parameter descriptions presented in chapter [Parameters](#).

Target audience

This manual is intended for people who design, commission, or operate the drive system.

Contents of the manual

This manual contains the following chapters:

- [Using the control panel](#) provides basic instructions for the use of the control panel.
- [Control locations and operating modes](#) describes the control locations and operating modes of the drive.
- [Program features](#) contains descriptions of the features of the ACS880-M04 primary control program.
- [Application macros](#) contains a short description of each macro together with a connection diagram. Macros are pre-defined applications which will save the user time when configuring the drive.
- [Parameters](#) describes the parameters used to program the drive.
- [Additional parameter data](#) contains further information on the parameters.
- [Fault tracing](#) lists the warning and fault messages with possible causes and remedies.
- [Fieldbus control through the embedded fieldbus interface \(EFB\)](#) describes the communication to and from a fieldbus network using the embedded fieldbus interface of the drive.
- [Fieldbus control through a fieldbus adapter](#) describes the communication to and from a fieldbus network using an optional fieldbus adapter module.
- [Control chain diagrams](#) showing the parameter structure within the drive.

Related documents

Note: A quick start-up sequence for a speed control application is provided by *ACS880-M04 Quick installation and start-up guide* (3AXD50000032345), delivered with the drive.

See the [List of related manuals](#) on the inside of front cover.

Terms and abbreviations

Term/ abbreviation	Definition
ACS800	A product family of ABB drives
ACS-AP-I, ACS-AP-W	Assistant control panel. Type of control panels used with ACS880-M04 drives
ACS-BP-S	Basic control panel
AI	Analog input; interface for analog input signals
AO	Analog output; interface for analog output signals
DC link	DC circuit between rectifier and inverter
DDCS	Distributed drives communication system; a protocol used in communication between ABB drive equipment
DI	Digital input; interface for digital input signals
DIO	Digital input/output; interface that can be used as a digital input or output
DO	Digital output; interface for digital output signals
Drive	Frequency converter for controlling AC motors. The drive consists of a rectifier and an inverter connected together by the DC link. In drives up to approximately 500 kW, these are integrated into a single module (drive module). Larger drives typically consist of separate supply and inverter units. The ACS880-M04 primary control program is used to control the inverter part of the drive.
DriveBus	A communication link used by, for example, ABB controllers. ACS880-M04 drives can be connected to the DriveBus link of the controller.
DTC	Direct torque control. See page 45 .
FBA	Fieldbus adapter
FCAN-01	Optional CANopen adapter
FCNA-01	Optional ControlNet adapter
FDCO-0x	Optional DDCS communication module
FDNA-01	Optional DeviceNet adapter
FECA-01	Optional EtherCAT® adapter
FEN-01	Optional TTL encoder interface module
FEN-11	Optional absolute encoder interface module
FEN-21	Optional resolver interface module
FEN-31	Optional HTL encoder interface module
FENA-11	Optional Ethernet/IP, Modbus/TCP and PROFINET IO adapter
FENA-21	Optional dual-port Ethernet/IP, Modbus/TCP and PROFINET IO adapter
FEPL-02	Optional POWERLINK adapter
FIO-01	Optional digital I/O extension module
FIO-11	Optional analog I/O extension module
FPBA-01	Optional PROFIBUS DP adapter
FSCA-01	Optional Modbus/RTU adapter

Term/ abbreviation	Definition
FSO-xx	Optional safety functions module
HTL	High-threshold logic
ID run	Motor identification run. During the identification run, the drive will identify the characteristics of the motor for optimum motor control.
IGBT	Insulated gate bipolar transistor; a voltage-controlled semiconductor type widely used in inverters and IGBT supply units due to their easy controllability and high switching frequency
Inverter unit	In large drives (> 500 kW approx.), the part of the drive that converts DC to AC for the motor. Consists of one or more inverter modules and their auxiliary components.
I/O	Input/Output
ModuleBus	A communication link used by, for example, ABB controllers. ACS880-M04 drives can be connected to the optical ModuleBus link of the controller.
Motor-side converter	See <i>inverter unit</i> .
Network control	With fieldbus protocols based on the Common Industrial Protocol (CIP™), such as DeviceNet and Ethernet/IP, denotes the control of the drive using the Net Ctrl and Net Ref objects of the ODVA AC/DC Drive Profile. For more information, see www.odva.org , and the following manuals: <ul style="list-style-type: none"> • <i>FDNA-01 DeviceNet adapter module User's manual</i> (3AFE68573360 [English]), and • <i>FENA-01/-11 Ethernet adapter module User's manual</i> (3AUA0000093568 [English]).
Parameter	User-adjustable operation instruction to the drive, or signal measured or calculated by the drive
PLC	Programmable logic controller
Power unit	Contains the power electronics and power connections of the drive (or inverter module). The drive control unit is connected to the power unit.
PTC	Positive temperature coefficient
RFG	Ramp function generator.
RO	Relay output; interface for a digital output signal. Implemented with a relay.
SSI	Synchronous serial interface
STO	Safe torque off
TTL	Transistor-transistor logic
UPS	Uninterruptible power supply; power supply equipment with battery to maintain output voltage during power failure
ZCU	Type of control unit used in ACS880-M04 drives (primarily in drive modules, or inverter/supply units consisting of a single power module). Consists of an I/O board built into a plastic housing. Depending on the type of hardware, the control unit may be integrated into or fitted onto the drive/inverter module, or installed separately.



Using the control panel

Refer to

- *ACX-AP-x assistant control panels user's manual* (3AUA0000085685 [English])
and
- *ACS-BP-S assistant control panels user's manual* (3AXD50000032527 [English]).

3

Start-up

Contents of this chapter

This chapter describes the basic start-up sequence of an ACS880-M04 machinery drive.

In this guide, the drive is set up using the ACS-AP-I control panel. The start-up sequence can also be carried out using the Drive composer PC tool.

Before you start























Make sure the drive is mechanically and electrically installed as described in the *Quick installation guide* and/or *Hardware manual*.







Safety

WARNING! Follow all safety instructions of the drive. Only qualified electricians are allowed to start up the drive. Never work on the drive, the brake chopper circuit, the motor cable or the motor when power is applied to the drive. Always make sure by measuring that no voltage is actually present.

 **WARNING!** Make sure that the machinery into which the drive with brake control function is integrated fulfills the personnel safety regulations. Note that the frequency converter (a Complete Drive Module or a Basic Drive Module, as defined in IEC 61800-2), is not considered as a safety device mentioned in the European Machinery Directive and related harmonized standards. Thus, the personnel safety of the complete machinery must not be based on a specific frequency converter feature (such as the brake control function), but it has to be implemented as defined in the application specific regulations.

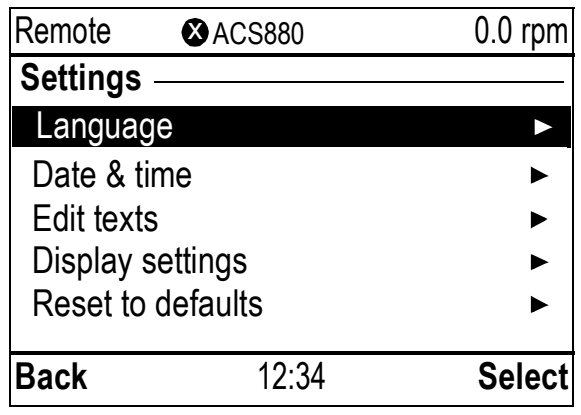
Start-up

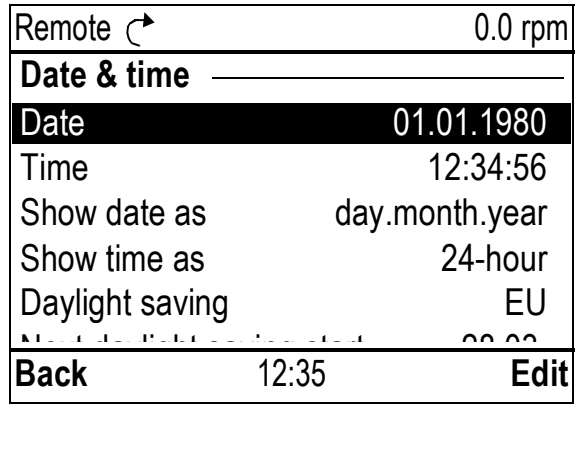

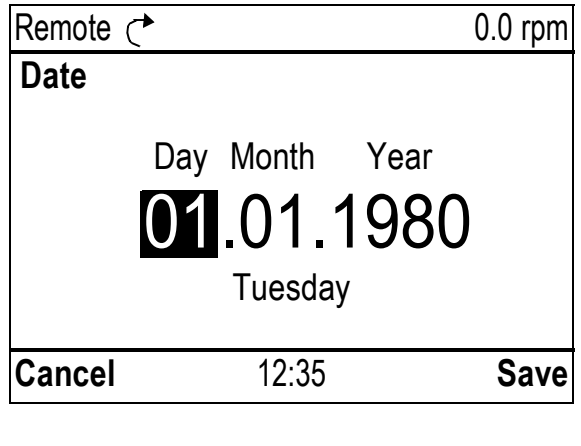







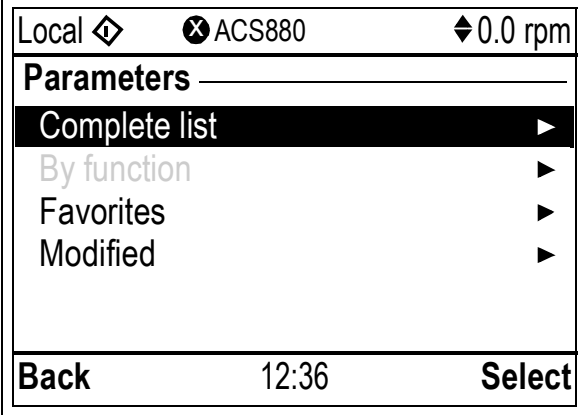









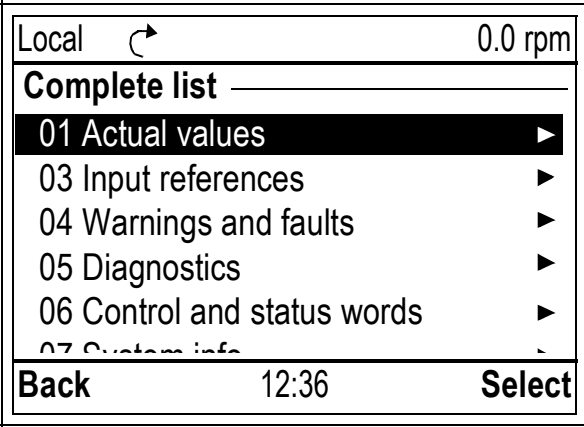





Safety																						
	WARNING! Obey all safety instructions for the drive. Only qualified electricians are allowed to start up the drive.																					
<input type="checkbox"/>	Check the installation. See the installation checklist in the <i>Hardware manual</i> .																					
<input type="checkbox"/>	<p>Check that the starting of the motor does not cause any danger.</p> <p>De-couple the driven machine if</p> <ul style="list-style-type: none"> • there is a risk of damage in case of an incorrect direction of rotation, or • a Normal ID run is required during the drive start-up, when the load torque is higher than 20% or the machinery is not able to withstand the nominal torque transient during the ID run. 																					
1 – Power-up, date and time settings																						
<input type="checkbox"/>	<p>Power up the drive.</p> <p>Note: It is normal that warning messages appear at various points along the start-up process. To hide a message and to resume the start-up process, press .</p> <p>Hide any warnings now to enter the Home view (shown on the right).</p> <p>The two commands at the bottom of the display (in this case, Options and Menu), show the functions of the two softkeys  and  located below the display. The commands assigned to the softkeys vary depending on the context.</p>																					
	<table border="1" style="width: 100%; border-collapse: collapse;"> <tr> <td style="text-align: left;">Remote</td> <td style="text-align: center;"> ACS880</td> <td style="text-align: right;">0.0 rpm</td> </tr> <tr> <td style="text-align: left;">Motor speed used</td> <td style="text-align: center;">rpm</td> <td style="text-align: right; font-size: 24pt;">0.00</td> </tr> <tr> <td style="text-align: left;">Motor current</td> <td style="text-align: center;">A</td> <td style="text-align: right; font-size: 24pt;">0.00</td> </tr> <tr> <td style="text-align: left;">Motor torque</td> <td style="text-align: center;">%</td> <td style="text-align: right; font-size: 24pt;">0.0</td> </tr> <tr> <td style="text-align: left;">Options</td> <td style="text-align: center;">12:34</td> <td style="text-align: right;">Menu</td> </tr> </table>	Remote	 ACS880	0.0 rpm	Motor speed used	rpm	0.00	Motor current	A	0.00	Motor torque	%	0.0	Options	12:34	Menu						
Remote	 ACS880	0.0 rpm																				
Motor speed used	rpm	0.00																				
Motor current	A	0.00																				
Motor torque	%	0.0																				
Options	12:34	Menu																				
<input type="checkbox"/>	<p>In the Home view, press  (Menu). The main Menu (right) appears.</p>																					
	<table border="1" style="width: 100%; border-collapse: collapse;"> <tr> <td style="text-align: left;">Remote</td> <td style="text-align: center;"></td> <td style="text-align: right;">0.0 rpm</td> </tr> <tr> <td colspan="3">Menu</td> </tr> <tr> <td style="text-align: left;"></td> <td style="text-align: left;">Parameters</td> <td style="text-align: right;">▶</td> </tr> <tr> <td style="text-align: left;"></td> <td style="text-align: left;">Assistants</td> <td style="text-align: right;">▶</td> </tr> <tr> <td style="text-align: left;"></td> <td style="text-align: left;">Energy efficiency</td> <td style="text-align: right;">▶</td> </tr> <tr> <td style="text-align: left;"></td> <td style="text-align: left;">Event log</td> <td style="text-align: right;">▶</td> </tr> <tr> <td style="text-align: left;">Exit</td> <td style="text-align: center;">12:34</td> <td style="text-align: right;">Select</td> </tr> </table>	Remote		0.0 rpm	Menu				Parameters	▶		Assistants	▶		Energy efficiency	▶		Event log	▶	Exit	12:34	Select
Remote		0.0 rpm																				
Menu																						
	Parameters	▶																				
	Assistants	▶																				
	Energy efficiency	▶																				
	Event log	▶																				
Exit	12:34	Select																				

<input type="checkbox"/>	<p>Highlight Settings on the menu using  and  and press  (Select).</p>	
<input type="checkbox"/>	<p>In the Settings menu, highlight Date & time (if not already highlighted) and press  (Select).</p>	
<input type="checkbox"/>	<p>In the Date & time menu, highlight Date (if not already highlighted) and press  (Select).</p>	

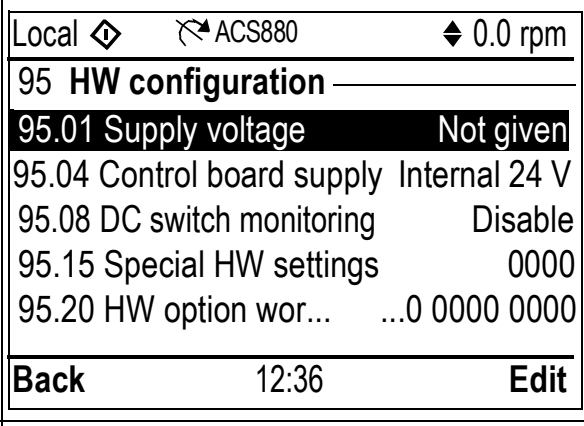
<input type="checkbox"/> <p>Set the correct date:</p> <ul style="list-style-type: none"> • Use and to move the cursor left and right. • Use and to change the value. • Press (Save) to accept the new setting. <p>Check/adjust all the remaining settings in the Date & time menu.</p> <p>The Show clock setting determines whether the time is shown at all times in the bottom pane of the display.</p> <p>After you have made the settings, press (Back or Exit) repeatedly until the Home view (right) reappears.</p>	<table border="1" style="width: 100%;"> <tr> <td style="text-align: left;">Remote</td> <td style="text-align: center;">↻ ACS880</td> <td style="text-align: right;">0.0 rpm</td> </tr> <tr> <td style="text-align: left;">Motor speed used rpm</td> <td style="text-align: center;">0.00</td> <td></td> </tr> <tr> <td style="text-align: left;">◀ Motor current A ▶</td> <td style="text-align: center;">0.00</td> <td></td> </tr> <tr> <td style="text-align: left;">Motor torque %</td> <td style="text-align: center;">0.0</td> <td></td> </tr> <tr> <td style="text-align: left;">Options</td> <td style="text-align: center;">12:34</td> <td style="text-align: right;">Menu</td> </tr> </table>	Remote	↻ ACS880	0.0 rpm	Motor speed used rpm	0.00		◀ Motor current A ▶	0.00		Motor torque %	0.0		Options	12:34	Menu
Remote	↻ ACS880	0.0 rpm														
Motor speed used rpm	0.00															
◀ Motor current A ▶	0.00															
Motor torque %	0.0															
Options	12:34	Menu														

2 – Supply voltage and motor data settings

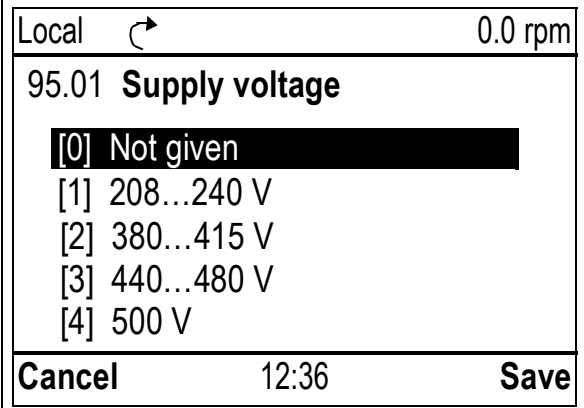
<input type="checkbox"/> <p>Switch to local control to ensure that external control is disabled by pressing the key. Local control is indicated by the text “Local” in the top pane.</p>	<table border="1" style="width: 100%;"> <tr> <td style="text-align: left;">Local</td> <td style="text-align: center;">↻</td> <td style="text-align: right;">0.0 rpm</td> </tr> <tr> <td style="text-align: left;">Motor speed used rpm</td> <td style="text-align: center;">0.00</td> <td></td> </tr> <tr> <td style="text-align: left;">◀ Motor current A ▶</td> <td style="text-align: center;">0.00</td> <td></td> </tr> <tr> <td style="text-align: left;">Motor torque %</td> <td style="text-align: center;">0.0</td> <td></td> </tr> <tr> <td style="text-align: left;">Options</td> <td style="text-align: center;">12:36</td> <td style="text-align: right;">Menu</td> </tr> </table>	Local	↻	0.0 rpm	Motor speed used rpm	0.00		◀ Motor current A ▶	0.00		Motor torque %	0.0		Options	12:36	Menu						
Local	↻	0.0 rpm																				
Motor speed used rpm	0.00																					
◀ Motor current A ▶	0.00																					
Motor torque %	0.0																					
Options	12:36	Menu																				
<input type="checkbox"/> <p>Open the main Menu by pressing (Menu).</p>	<table border="1" style="width: 100%;"> <tr> <td style="text-align: left;">Local</td> <td style="text-align: center;">↻</td> <td style="text-align: right;">0.0 rpm</td> </tr> <tr> <td colspan="3">Menu</td> </tr> <tr> <td style="text-align: left;"> Parameters</td> <td style="text-align: center;">▶</td> <td></td> </tr> <tr> <td style="text-align: left;"> Assistants</td> <td style="text-align: center;">▶</td> <td></td> </tr> <tr> <td style="text-align: left;"> Energy efficiency</td> <td style="text-align: center;">▶</td> <td></td> </tr> <tr> <td style="text-align: left;"> Event log</td> <td style="text-align: center;">▶</td> <td></td> </tr> <tr> <td style="text-align: left;">Exit</td> <td style="text-align: center;">12:36</td> <td style="text-align: right;">Select</td> </tr> </table>	Local	↻	0.0 rpm	Menu			Parameters	▶		Assistants	▶		Energy efficiency	▶		Event log	▶		Exit	12:36	Select
Local	↻	0.0 rpm																				
Menu																						
Parameters	▶																					
Assistants	▶																					
Energy efficiency	▶																					
Event log	▶																					
Exit	12:36	Select																				

<input type="checkbox"/>	<p>Highlight Parameters and press  (Select).</p>	 <p>Local   ACS880  0.0 rpm</p> <p>Parameters _____</p> <p>Complete list </p> <p>By function </p> <p>Favorites </p> <p>Modified </p> <hr/> <p>Back 12:36 Select</p>
<input type="checkbox"/>	<p>Highlight Complete list using  and  and press  (Select).</p> <p>A listing of parameter groups is displayed.</p>	 <p>Local  0.0 rpm</p> <p>Complete list _____</p> <p>01 Actual values </p> <p>03 Input references </p> <p>04 Warnings and faults </p> <p>05 Diagnostics </p> <p>06 Control and status words </p> <p>07 System info </p> <hr/> <p>Back 12:36 Select</p>
<input type="checkbox"/>	<p>Highlight parameter group 95 HW configuration and press  (Select).</p> <p>Note that the list wraps around in either direction between groups 99 and 01. In this case, it is quicker to use  to locate group 95 on the list.</p> <p>After selecting a group, a listing of parameters within the group is displayed.</p>	 <p>Local   ACS880  0.0 rpm</p> <p>95 HW configuration _____</p> <p>95.01 Supply voltage Not given</p> <p>95.04 Control board supply Internal 24 V</p> <p>95.08 DC switch monitoring Disable</p> <p>95.15 Special HW settings 0000</p> <p>95.20 HW option wor... ...0 0000 0000</p> <hr/> <p>Back 12:36 Edit</p>
<input type="checkbox"/>	<p>Highlight parameter 95.01 Supply voltage (if not already highlighted) and press  (Edit).</p> <p>The available parameter settings are listed.</p>	 <p>Local  0.0 rpm</p> <p>95.01 Supply voltage</p> <p>[0] Not given</p> <p>[1] 208...240 V</p> <p>[2] 380...415 V</p> <p>[3] 440...480 V</p> <p>[4] 500 V</p> <hr/> <p>Cancel 12:36 Save</p>

<input type="checkbox"/>	Highlight the correct setting on the list and press (Save).	<table border="1" style="width: 100%; border-collapse: collapse;"> <tr> <td style="text-align: left;">Local </td> <td style="text-align: center;">ACS880</td> <td style="text-align: right;">◆ 0.0 rpm</td> </tr> <tr> <td colspan="3">95 HW configuration</td> </tr> <tr> <td style="background-color: #e0e0e0;">95.01 Supply voltage</td> <td colspan="2" style="background-color: #e0e0e0;">380...415 V</td> </tr> <tr> <td>95.04 Control board supply</td> <td colspan="2">Internal 24 V</td> </tr> <tr> <td>95.08 DC switch monitoring</td> <td colspan="2">Disable</td> </tr> <tr> <td>95.15 Special HW settings</td> <td colspan="2">0000</td> </tr> <tr> <td>95.20 HW option wor...</td> <td colspan="2">...0 0000 0000</td> </tr> <tr> <td style="text-align: left;">Back</td> <td style="text-align: center;">12:36</td> <td style="text-align: right;">Edit</td> </tr> </table>	Local	ACS880	◆ 0.0 rpm	95 HW configuration			95.01 Supply voltage	380...415 V		95.04 Control board supply	Internal 24 V		95.08 DC switch monitoring	Disable		95.15 Special HW settings	0000		95.20 HW option wor...	...0 0000 0000		Back	12:36	Edit
Local	ACS880	◆ 0.0 rpm																								
95 HW configuration																										
95.01 Supply voltage	380...415 V																									
95.04 Control board supply	Internal 24 V																									
95.08 DC switch monitoring	Disable																									
95.15 Special HW settings	0000																									
95.20 HW option wor...	...0 0000 0000																									
Back	12:36	Edit																								

Press (**Back**) to display the list of parameter groups again. Select parameter group **99 Motor data**, and set parameter **99.03 Motor type**.

Set parameter **99.04 Motor control mode**.
DTC = Direct torque control; **Scalar**
 DTC is suitable for most cases. Scalar mode is recommended if

- the nominal current of the motor is less than 1/6 of the nominal current of the drive,
- the drive is used for test purposes with no motor connected, or
- the drive controls multiple motors and the number of motors connected is variable.

Refer to the motor nameplate for the following parameter settings. Whenever possible, enter the values exactly as shown on the motor nameplate.

Example of a nameplate of an induction (asynchronous) motor:

ABB Motors									
3 ~ motor		M2AA 200 MLA 4							
IEC 200 M/L 55									
No									
Ins.cl. F					IP 55				
V	Hz	kW	r/min	A	cos φ	IA/IN	t _{E/s}		
690 Y	50	30	1475	32.5	0.83				
400 D	50	30	1475	56	0.83				
660 Y	50	30	1470	34	0.83				
380 D	50	30	1470	59	0.83				
415 D	50	30	1475	54	0.83				
440 D	60	35	1770	59	0.83				
Cat. no 3GAA 202 001 - ADA									
6312/C3		6210/C3			180 kg				
IEC 34-1									

Example of a nameplate of a permanent magnet motor:



ABB Motors									
3 ~ motor		M2BJ 280SMB 10 B3							
S1 SPEC INSUL. No 3424522									
JK-21640-1					Ins.cl. F		IP 55		
V	Hz	kW	r/min	A	cos φ	IA/IN	t _{E/s}		
400 D	50	55	600	103	0.97				
Prod. code		2GBJ285220-ADA405445477							
6316/C3		6316/C3			630kg				
IEC 34-1									

99.06 Motor nominal current
 The allowable range is

- in DTC mode: $1/6 \times I_{Hd} \dots 2 \times I_{Hd}$ of the drive
- in Scalar mode: $0 \dots 2 \times I_{Hd}$

Note: With numerical parameter values:

- Use and to change the value of a digit.
- Use and to move the cursor left and right.
- Press (**Save**) to enter the value.

Make the following parameter settings in the same manner.		
<input type="checkbox"/>	<p>99.07 Motor nominal voltage</p> <p>The allowable range is $1/6 \times U_N \dots 2 \times U_N$ of the drive.</p> <p>With permanent magnet motors, the nominal voltage is the BackEMF voltage at nominal speed. If the voltage is given in volt/rpm (eg. 60 V per 1000 rpm), the voltage at a nominal speed of 3000 rpm is $3 \times 60 \text{ V} = 180 \text{ V}$. Note that nominal voltage is not the same as equivalent DC motor voltage (EDCM) given by some manufacturers. The nominal voltage can be calculated by dividing the EDCM voltage by 1.7 (or square root of 3).</p>	
<input type="checkbox"/>	<p>99.08 Motor nominal frequency</p> <p>With permanent magnet motors, if the nominal frequency is not shown on the nameplate, it can be calculated using the following formula:</p> $f = n \times p / 60$ <p>where n = nominal motor speed, p = number of pole pairs.</p>	
<input type="checkbox"/>	99.09 Motor nominal speed	
<input type="checkbox"/>	99.10 Motor nominal power	
<input type="checkbox"/>	<p>99.11 Motor nominal $\cos \Phi$ 99.12 Motor nominal torque</p> <p>These values are not required, but can be entered to improve control accuracy. If you do not know the correct values, leave the parameters at 0. DO NOT enter estimated values.</p>	
<input type="checkbox"/>	<p>99.13 ID run requested</p> <p>This parameter selects the mode of the identification run (DTC motor control mode only).</p> <p>Note: The drive must be in local control for the identification run.</p> <p> WARNING! The identification run modes marked thus * will run the motor in the forward direction (see below for details). Make sure it is safe to run the motor before choosing any of these modes.</p> <p>*Normal mode should be selected whenever possible.. The driven machinery must be de-coupled from the motor if</p> <ul style="list-style-type: none"> • the load torque is higher than 20%, or • the machinery is not able to withstand the nominal torque transient during the identification run. <p>*Reduced mode should be selected if the mechanical losses are higher than 20%, ie. the load cannot be de-coupled, or full flux is required to keep the motor brake open (eg. with conical motors).</p> <p>The Standstill mode should be selected if neither the *Normal or *Reduced mode can be used. Notes:</p> <ul style="list-style-type: none"> • This mode cannot be used with a permanent magnet motor if the load torque is higher than 20% of nominal. • Mechanical brake is not opened by the logic for the identification run. 	
<input type="checkbox"/>	Ensure that the Safe torque off and emergency stop circuits (if present) are closed.	
<input type="checkbox"/>	<p>Start the identification run by pressing the  (Start) button.</p>	A warning will indicate that the identification run is in progress.



Check that the motor runs in the correct direction (forward direction shown below).

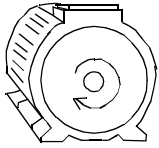

The identification run has completed when the drive stops and the value of parameter [99.13](#) reverts to *None*.

If the motor ran in the wrong direction, correct the motor cabling or adjust parameter [99.16 Motor phase order](#).



Control locations and operating modes

What this chapter contains

This chapter describes the control locations and operating modes supported by the control program.

Local control vs. external control

The ACS880-M04 has two main control locations: external and local. The control location is selected with the Loc/Rem key on the control panel or in the PC tool.

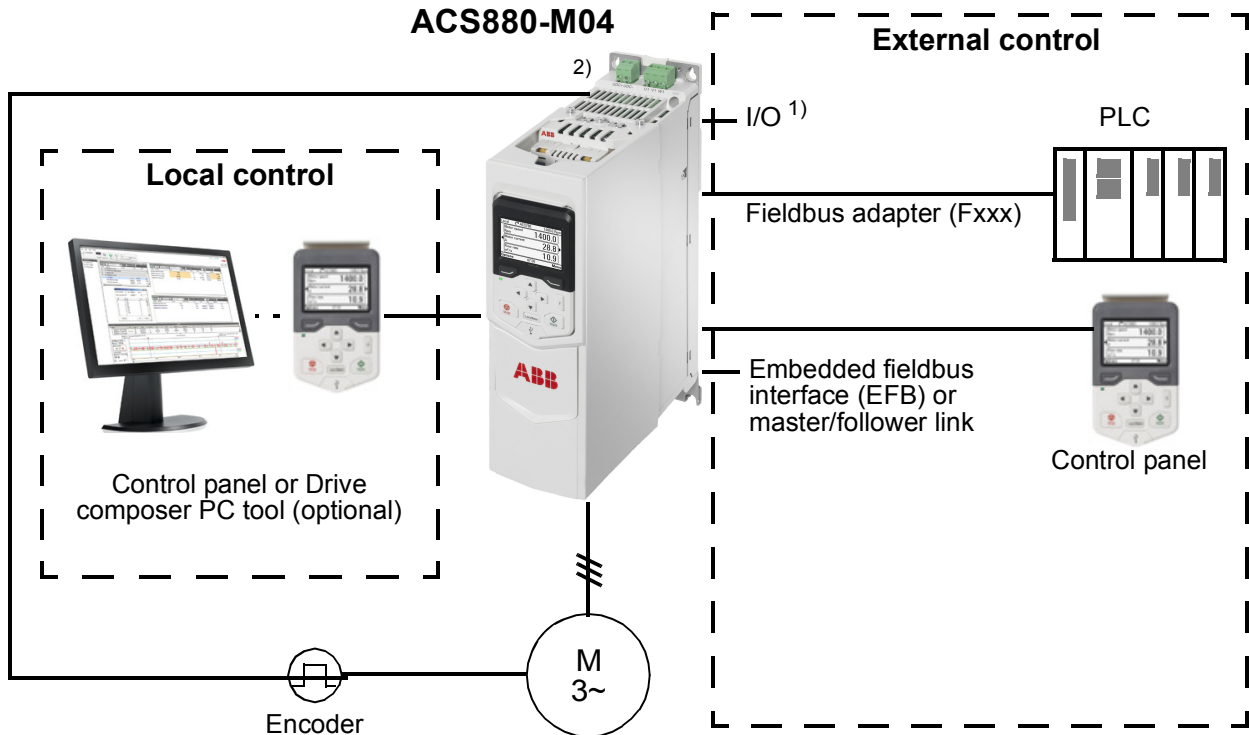

1) Extra inputs/outputs can be added by installing optional I/O extension modules (FIO-xx) in drive slots.

2) Encoder or resolver interface module(s) (FEN-xx) installed in drive slots.

Local control

The control commands are given from the control panel keypad or from a PC equipped with Drive composer when the drive is set to local control. Speed and torque control modes are available for local control; frequency mode is available when scalar motor control mode is used (see parameter [19.16 Local control mode](#)).

Local control is mainly used during commissioning and maintenance. The control panel always overrides the external control signal sources when used in local control. Changing the control location to local can be prevented by parameter [19.17 Local control disable](#).

The user can select by a parameter ([49.05 Communication loss action](#)) how the drive reacts to a control panel or PC tool communication break. (The parameter has no effect in external control.)

■ External control

When the drive is in external control, control commands are given through

- the I/O terminals (digital and analog inputs), or optional I/O extension modules
- the embedded fieldbus interface or an optional fieldbus adapter module
- the master/follower link, and/or
- the control panel.

Two external control locations, EXT1 and EXT2, are available. The user can select the sources of the start and stop commands separately for each location by parameters [20.01...20.10](#). The operating mode can be selected separately for each location (in parameter group [19 Operation mode](#)), which enables quick switching between different operating modes, for example speed and torque control. Selection between EXT1 and EXT2 is done via any binary source such as a digital input or fieldbus control word (see parameter [19.11 Ext1/Ext2 selection](#)). The source of reference is selectable for each operating mode separately.

Using the control panel as an external control source

The control panel can also be used as a source of start/stop commands and/or reference in external control. Selections for the control panel are available in the start/stop command source and reference source selection parameters.

Reference source selection parameters have two selections for the control panel. The difference between the two selections is in the initial reference value after the reference source switches to the control panel.

The panel reference is saved whenever another reference source is selected. If the reference source selection parameter is set to [Control panel \(ref saved\)](#), the saved value is used as the initial reference when control switches back to the panel. Note that only one type of reference can be saved at a time: for example, attempting to use the same saved reference with different operating modes (speed, torque, etc.) causes the drive to trip on [7083 Panel reference conflict](#). The panel reference can be separately limited by parameters in group [49 Panel port communication](#).

With the reference source selection parameter set to [Control panel \(ref copied\)](#), the initial panel reference value depends on whether the operating mode changes with the reference source. If the source switches to the panel and the operating mode does not change, the last reference from the previous source is adopted. If the operating mode changes, the drive actual value corresponding to the new mode is adopted as the initial value.

Operating modes of the drive

The drive can operate in several operating modes with different types of reference. The mode is selectable for each control location (Local, EXT1 and EXT2) in parameter group [19 Operation mode](#).

The following is a general representation of the reference types and control chains. The page numbers refer to detailed diagrams in chapter [Control chain diagrams](#).

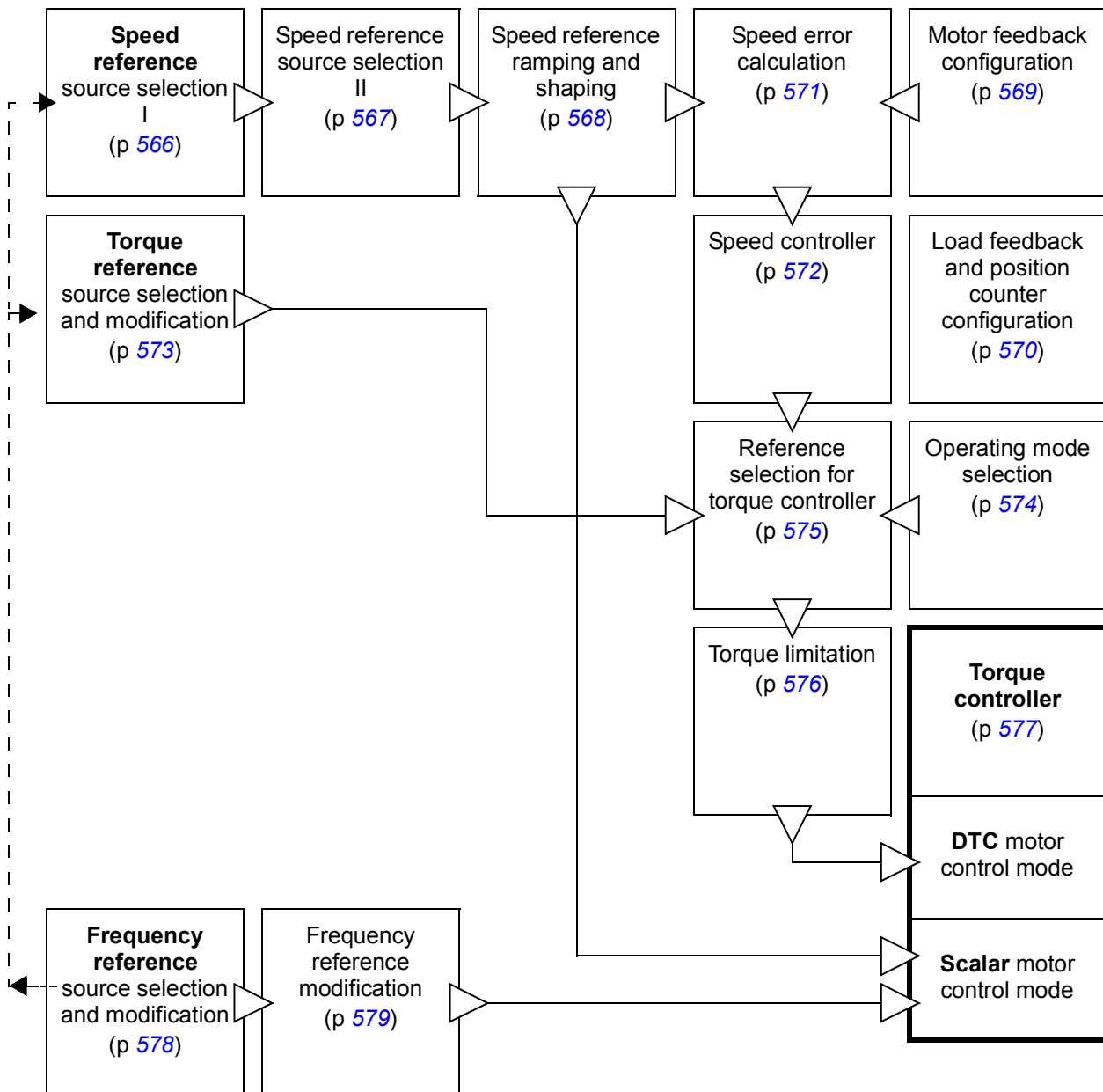

■ Speed control mode

The motor follows a speed reference given to the drive. This mode can be used either with estimated speed as feedback, or with an encoder or resolver for better speed control accuracy.

Speed control mode is available in both local and external control. It is also available both in DTC (Direct Torque Control) and scalar motor control modes.

■ Torque control mode

Motor torque follows a torque reference given to the drive. Torque control is possible without feedback, but is much more dynamic and accurate when used in conjunction with a feedback device such as an encoder or a resolver. It is recommended that a feedback device is used in crane, winch or lift control situations.

Torque control mode is available in DTC motor control mode for both local and external control locations.

■ Frequency control mode

The motor follows a frequency reference given to the drive. Frequency control is only available in scalar motor control mode.

■ Special control modes

In addition to the control modes mentioned above, the following special control modes are available:

- Emergency stop modes Off1 and Off3: Drive stops along the defined deceleration ramp and drive modulation stops.
 - Jogging mode: Drive starts and accelerates to the defined speed when the jogging signal is activated. For more information, see section [Jogging](#) (page 57).
-



Program features

What this chapter contains

The control program contains all of the parameters (including actual signals) within the drive. This chapter describes some of the more important functions within the control program, how to use them and how to program them to operate.

Drive configuration and programming

The drive control program is divided into two parts:

- firmware program
- application program.

Drive control program

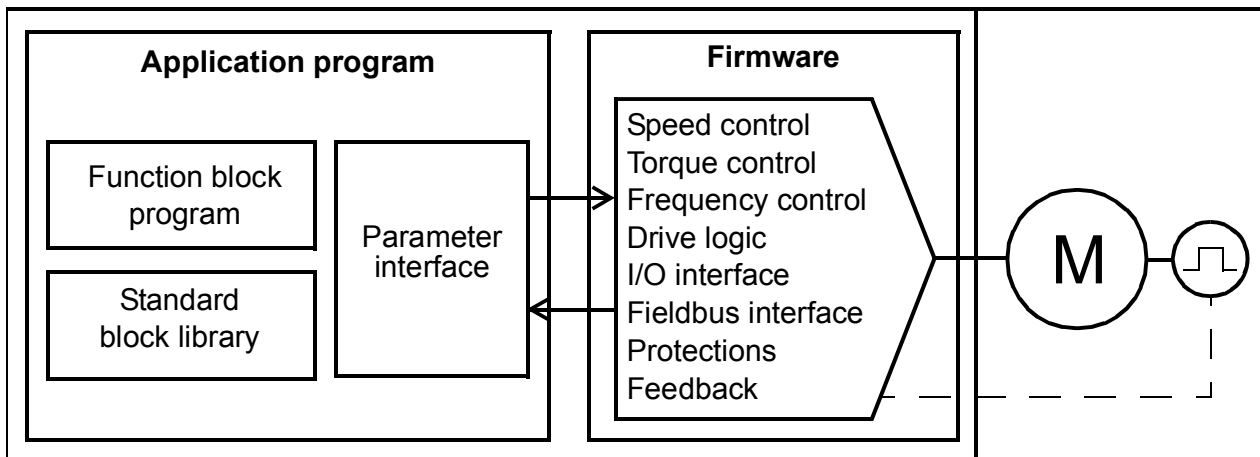

The firmware program performs the main control functions, including speed and torque control, drive logic (start/stop), I/O, feedback, communication and protection functions. Firmware functions are configured and programmed with parameters, and can be extended by application programming.

■ Programming via parameters

Parameters configure all of the standard drive operations and can be set via

- the control panel, as described in chapter [Using the control panel](#)
- the Drive composer PC tool, as described in *Drive composer user's manual* (3AUA0000094606 [English]), or
- the fieldbus interface, as described in chapters [Fieldbus control through the embedded fieldbus interface \(EFB\)](#) and [Fieldbus control through a fieldbus adapter](#).

All parameter settings are stored automatically to the permanent memory of the drive. However, if an external +24 V DC power supply is used for the drive control unit, it is highly recommended to force a save by using parameter [96.07 Parameter save manually](#) before powering down the control unit after any parameter changes have been made.

If necessary, the default parameter values can be restored by parameter [96.06 Parameter restore](#).

■ Adaptive programming

Conventionally, the user can control the operation of the drive by parameters. However, the standard parameters have a fixed set of choices or a setting range. To further customize the operation of the drive, an adaptive program can be constructed out of a set of function blocks.

The Drive composer pro PC tool (version 1.9 or later, available separately) has an Adaptive programming feature with a graphical user interface for building the custom program. The function blocks include the usual arithmetic and logical functions, as well as eg. selection, comparison and timer blocks. The program can contain approximately 20 blocks depending on block size and the number of inputs and outputs used.

The physical inputs, drive status information, actual values, constants and data storage parameters can be used as the input for the program. The output of the program can be used eg. as a start signal, external event or reference, or connected to the drive outputs. See below for a listing of the available inputs and outputs. Note that connecting the output of the adaptive program to a selection parameter will write-protect the parameter.

The status of the adaptive program is shown by parameter [07.30 Adaptive program status](#).

For more information, see the *Adaptive programming application guide* (3AXD50000028574 [English]).

Inputs available to the adaptive program	
Input	Source
<i>I/O</i>	
DI1	10.02 DI delayed status , bit 0
DI2	10.02 DI delayed status , bit 1
DI3	10.02 DI delayed status , bit 2
DI4	10.02 DI delayed status , bit 3
DI5	10.02 DI delayed status , bit 4
DI6	10.02 DI delayed status , bit 5
DIIL	10.02 DI delayed status , bit 15
AI1	12.11 AI1 actual value
AI2	12.21 AI2 actual value
DIO1	11.02 DIO delayed status , bit 0
DIO2	11.02 DIO delayed status , bit 1
<i>Actual signals</i>	
Motor speed	01.01 Motor speed used
Output frequency	01.06 Output frequency
Motor current	01.07 Motor current
Motor torque	01.10 Motor torque
Motor shaft power	01.17 Motor shaft power
<i>Status</i>	
Enabled	06.16 Drive status word 1 , bit 0
Inhibited	06.16 Drive status word 1 , bit 1
Ready to start	06.16 Drive status word 1 , bit 3

34 Program features

Inputs available to the adaptive program	
<i>Input</i>	<i>Source</i>
Tripped	06.11 Main status word , bit 3
At setpoint	06.11 Main status word , bit 8
Limiting	06.16 Drive status word 1 , bit 7
Ext1 active	06.16 Drive status word 1 , bit 10
Ext2 active	06.16 Drive status word 1 , bit 11
<i>Data storage</i>	
Data storage 1 real32	47.01 Data storage 1 real32
Data storage 2 real32	47.02 Data storage 2 real32
Data storage 3 real32	47.03 Data storage 3 real32
Data storage 4 real32	47.04 Data storage 4 real32
Data storage 5 real32	47.05 Data storage 5 real32
Data storage 6 real32	47.06 Data storage 6 real32
Data storage 7 real32	47.07 Data storage 7 real32
Data storage 8 real32	47.08 Data storage 8 real32
Outputs available to the adaptive program	
<i>Output</i>	<i>Target</i>
<i>I/O</i>	
RO1	10.24 RO1 source
RO2	10.27 RO2 source
RO3	10.30 RO3 source
AO1	13.12 AO1 source
AO2	13.22 AO2 source
DIO1	11.06 DIO1 output source
DIO2	11.10 DIO2 output source
<i>Start control</i>	
Ext1/Ext2 selection	19.11 Ext1/Ext2 selection
Run enable 1	20.12 Run enable 1 source
Ext1 in1 cmd	20.03 Ext1 in1 source
Ext1 in2 cmd	20.04 Ext1 in2 source
Ext1 in3 cmd	20.05 Ext1 in3 source
Ext2 in1 cmd	20.08 Ext2 in1 source
Ext2 in2 cmd	20.09 Ext2 in2 source
Ext2 in3 cmd	20.10 Ext2 in3 source
Fault reset	31.11 Fault reset selection
<i>Speed control</i>	
Ext1 speed reference	22.11 Speed ref1 source
Ext2 speed reference	22.12 Speed ref2 source
Speed additive 1	22.15 Speed additive 1 source
<i>Frequency control</i>	
Ext1 frequency reference	28.11 Frequency ref1 source
Ext2 frequency reference	28.12 Frequency ref2 source
<i>Torque control</i>	
Ext1 torque reference	26.11 Torque ref1 source
Ext2 torque reference	26.12 Torque ref2 source
Torque additive 2	26.25 Torque additive 2 source
<i>Limit function</i>	
Minimum torque 2	30.21 Minimum torque 2 source
Maximum torque 2	30.22 Maximum torque 2 source

Outputs available to the adaptive program	
<i>Output</i>	<i>Target</i>
<i>Events</i>	
External event 1	31.01 External event 1 source
External event 2	31.03 External event 2 source
External event 3	31.05 External event 3 source
External event 4	31.07 External event 4 source
External event 5	31.09 External event 5 source

■ Application programming

The functions of the firmware program can be extended with application programming. Application programmability is optionally available for the ACS880-M04 primary control program.

Application programs can be built out of function blocks based on the IEC 61131-3 standard using a PC tool available separately.

For more information, see *Programming manual: Drive application programming (IEC 61131-3)* (3AUA0000127808 [English]).

Control interfaces

■ Programmable analog inputs

The control unit has two programmable analog inputs. Each of the inputs can be independently set as a voltage (0/2...10 V or -10...10 V) or current (0/4...20 mA) input by a jumper or switch on the control unit. Each input can be filtered, inverted and scaled. The number of analog inputs can be increased by installing FIO-11 I/O extensions (see [Programmable I/O extensions](#) below).

The drive can be set to perform an action (for example, to generate a warning or fault) if the value of an analog input moves out of a predefined range.

Settings

Parameter group [12 Standard AI](#) (page [136](#)).

■ Programmable analog outputs

The control unit has two current (0...20 mA) analog outputs. Each output can be filtered, inverted and scaled. The number of analog outputs can be increased by installing FIO-11 I/O extensions (see [Programmable I/O extensions](#) below).

Settings

Parameter group [13 Standard AO](#) (page [141](#)).

■ Programmable digital inputs and outputs

The control unit has six digital inputs, a digital start interlock input, and two digital input/outputs (I/O that can be set as either an input or an output).

One digital input (DI6) doubles as a PTC thermistor input. See section [Motor thermal protection](#) (page [73](#)).

Digital input/output DIO1 can be used as a frequency input, DIO2 as a frequency output.

The number of digital inputs/outputs can be increased by installing FIO-01 or FIO-11 I/O extensions (see [Programmable I/O extensions](#) below).

Settings

Parameter groups [10 Standard DI, RO](#) (page [122](#)) and [11 Standard DIO, FI, FO](#) (page [130](#)).

■ Programmable relay outputs

The control unit has three relay outputs. The signal to be indicated by the outputs can be selected by parameters.

Relay outputs can be added by installing FIO-01 I/O extensions.

Settings

Parameter group [10 Standard DI, RO](#) (page [122](#)).

■ Programmable I/O extensions

Inputs and outputs can be added by using I/O extension modules. One or two modules can be mounted on the slots of the control unit.

The table below shows the number of I/O on the control unit as well as optional I/O extension modules.

Location	Digital inputs (DI)	Digital I/Os (DIO)	Analog inputs (AI)	Analog outputs (AO)	Relay outputs (RO)
Control unit	6 + DIIL	2	2	2	3
FIO-01	-	4	-	-	2
FIO-11	-	2	3	1	-

Two I/O extension modules can be activated and configured using parameter groups 14...15.

Note: Each configuration parameter group contains parameters that display the values of the inputs on that particular extension module. These parameters are the only way of utilizing the inputs on I/O extension modules as signal sources. To connect to an input, choose the setting *Other* in the source selector parameter, then specify the appropriate value parameter (and bit, for digital signals) in group 14 and 15.

Settings

Parameter groups [14 I/O extension module 1](#) (page [147](#)) and [15 I/O extension module 2](#) (page [169](#)).

■ Fieldbus control

The drive can be connected to several different automation systems through its fieldbus interfaces. See chapters [Fieldbus control through the embedded fieldbus interface \(EFB\)](#) (page 527) and [Fieldbus control through a fieldbus adapter](#) (page 551).

Settings

Parameter groups [50 Fieldbus adapter \(FBA\)](#) (page 330), [51 FBA A settings](#) (page 341), [52 FBA A data in](#) (page 342), and [53 FBA A data out](#) (page 343), [54 FBA B settings](#) (page 344), [55 FBA B data in](#) (page 345), [56 FBA B data out](#) (page 346), and [58 Embedded fieldbus](#) (page 346).

Master/follower functionality

General

The master/follower functionality can be used to link several drives together so that the load can be evenly distributed between the drives. This is ideal in applications where the motors are coupled to each other via gearing, chain, belt, etc.

The external control signals are typically connected to one drive only which acts as the master. The master controls up to 10 followers by sending broadcast messages over an electrical cable or fiber optic link. The master can read feedback signals from up to 3 selected followers.

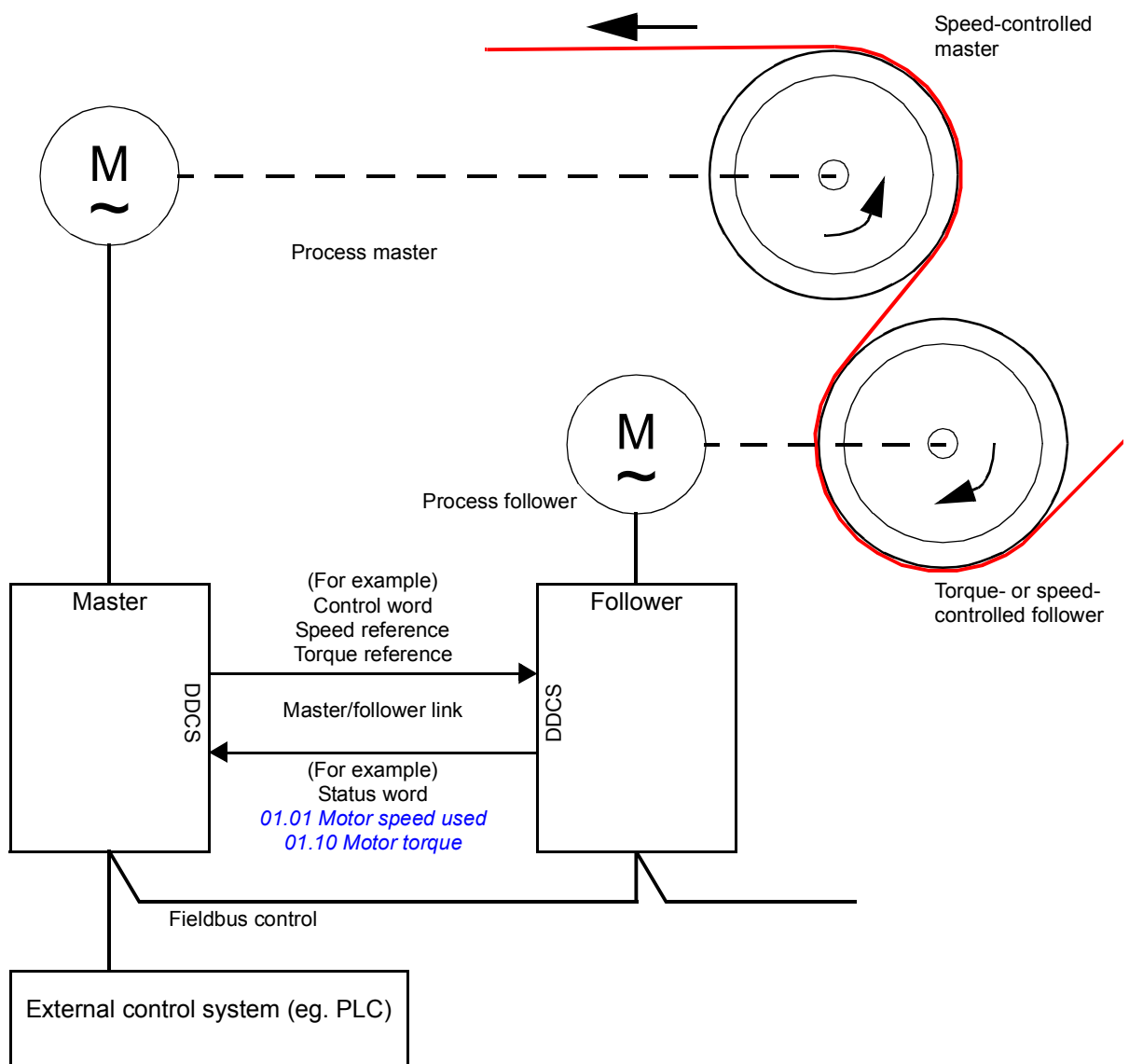

The master drive is typically speed-controlled and the other drives follow its torque or speed reference. In general, a follower should be

- torque-controlled when the motor shafts of the master and the follower are rigidly coupled by gearing, chain etc. so that no speed difference between the drives is possible
- speed-controlled when the motor shafts of the master and the follower are flexibly coupled so that a slight speed difference is possible. When both the master and the follower are speed-controlled, drooping is also typically used (see parameter [25.08 Drooping rate](#)). The distribution of load between the master and follower can alternatively be adjusted as described under [Load share function with a speed-controlled follower](#) below.

Note: With a speed-controlled follower (without load sharing), pay attention to the acceleration and deceleration ramp times of the follower. If the ramp times are set longer than in the master, the follower will follow its own acceleration/deceleration ramp times rather than those from the master. In general, it is recommended to set identical ramp times in both the master and the follower(s). Any ramp shape settings (see parameters [23.16...23.19](#)) should only be applied in the master.

In some applications, both speed control and torque control of the follower are required. In those cases, the operating mode can be switched by parameter ([19.12 Ext1 control mode](#) or [19.14 Ext2 control mode](#)). Another method is to set one external control location to speed control mode, the other to torque control mode. Then, a digital input of the follower can be used to switch between the control locations. See chapter [Control locations and operating modes](#) (page [25](#)).

With torque control, follower parameter [26.15 Load share](#) can be used to scale the incoming torque reference for optimal load sharing between the master and the follower. Some torque-controlled follower applications, eg. where the torque is very low, or very low speed operation is required, may require encoder feedback.

If a drive needs to quickly switch between master and follower statuses, one user parameter set (see page [82](#)) can be saved with the master settings, another with the follower settings. The suitable settings can then be activated using eg. digital inputs.

Load share function with a speed-controlled follower

Load sharing between the master and a speed-controlled follower can be used in various applications. The load share function is implemented by fine-tuning the follower speed reference with an additional term based on a torque reference. The torque reference is selected by parameter [23.42 Follower speed corr torq source](#) (by default, reference 2 received from the master). Load share is adjusted by parameter [26.15 Load share](#) and activated by the source selected by [23.40 Follower speed correction enable](#). Parameter [23.41 Follower speed correction gain](#) provides a gain adjustment for the speed correction. The final correction term added to the speed reference is shown by [23.39 Follower speed correction out](#). See the block diagram on page [571](#).

Notes:

- The function can be enabled only when the drive is a speed-controlled follower in remote control mode.
- Drooping ([25.08 Drooping rate](#)) is ignored when the load share function is active.
- The master and follower should have the same speed control tuning values.
- The speed correction term is limited by the speed error window parameters [24.44 Speed error window low](#) and [24.43 Speed error window high](#). An active limitation is indicated by [06.19 Speed control status word](#).

Communication

A master/follower link can be built by connecting the drives together with fiber optic cables (may require additional equipment depending on existing drive hardware), or by wiring together the XD2D connectors of the drives. The medium is selected by parameter [60.01 M/F communication port](#).

Parameter [60.03 M/F mode](#) defines whether the drive is the master or a follower on the communication link. Typically, the speed-controlled process master drive is also configured as the master in the communication.

The communication on the master/follower link is based on the DDCS protocol, which employs data sets (specifically, data set 41). One data set contains three 16-bit words. The contents of the data set are freely configurable using parameters [61.01...61.03](#). The data set broadcast by the master typically contains the control word, speed reference and torque reference, while the followers return a status word with two actual values.

The default setting of parameter [61.01 M/F data 1 selection](#) is *Follower CW*. With this setting in the master, a word consisting of bits 0...11 of [06.01 Main control word](#) and four bits selected by parameters [06.45...06.48](#) is broadcast to the followers. However, bit 3 of the follower control word is modified so that it remains on as long as the master is modulating, and its switching to 0 causes the follower to coast to a stop. This is to synchronize the stopping of both master and follower.

Note: When the master is ramping down to a stop, the follower observes the decreasing reference but receives no stop command until the master stops modulating and clears bit 3 of the follower control word. Because of this, the maximum and minimum speed limits on the follower drive should not have the same sign – otherwise the follower would be pushing against the limit until the master finally stops.

Three words of additional data can optionally be read from each follower. The followers from which data is read are selected by parameter [60.14 M/F follower selection](#) in the master. In each follower drive, the data to be sent is selected by parameters [61.01...61.03](#). The data is transferred in integer format over the link, and displayed by parameters [62.28...62.36](#) in the master. The data can then be forwarded to other parameters using [62.04...62.12](#).

To indicate faults in the followers, each follower must be configured to transmit its status word as one of the above-mentioned data words. In the master, the corresponding target parameter must be set to *Follower SW*. The action to be taken when a follower is faulted is selected by *60.17 Follower fault action*. External events (see parameter group *31 Fault functions*) can be used to indicate the status of other bits of the status word.

Block diagrams of the master/follower communication are presented on pages [580](#) and [581](#).

Construction of the master/follower link

The master/follower link is formed by connecting the drives together using shielded twisted-pair cable between the XD2D terminals of the drives.

Master/follower wiring with electrical cable

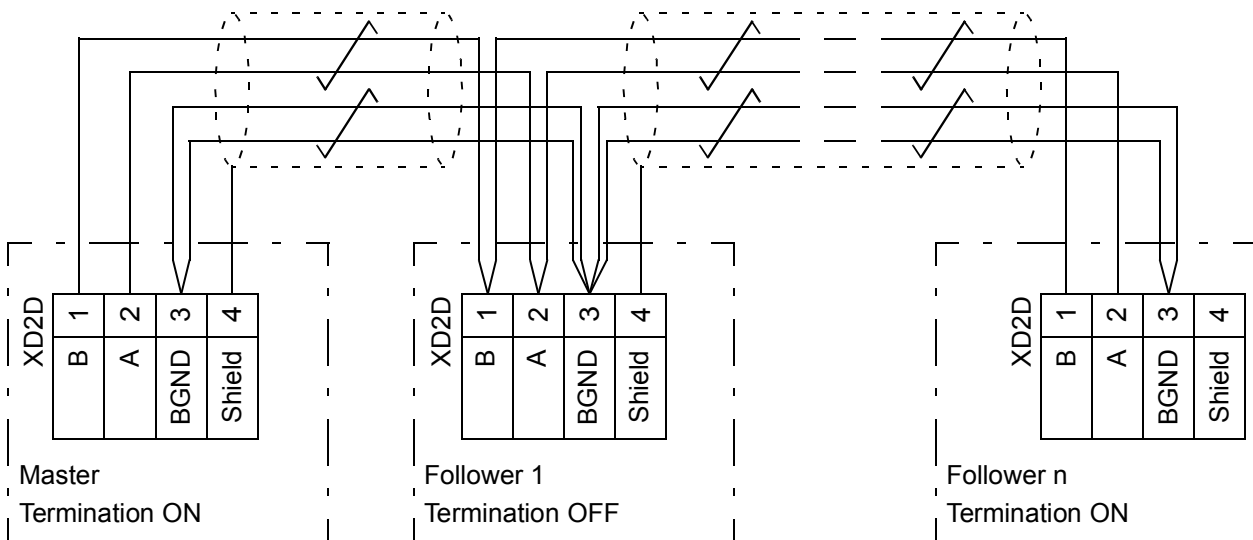

See the hardware manual of the drive for wiring and termination details.

Example parameter settings

The following is a checklist of parameters that need to be set when configuring the master/follower link. In this example, the master broadcasts the Follower control word, a speed reference and a torque reference. The follower returns a status word and two actual values (this is not compulsory but is shown for clarity).

Master settings:

- Master/follower link activation
 - [60.01 M/F communication port](#) (XD2D selection)
 - ([60.02 M/F node address](#) = 1)
 - [60.03 M/F mode](#) = D2D master

- *60.05 M/F HW connection* (*Ring* for fiber optic)
- Data to be broadcast to the followers
 - *61.01 M/F data 1 selection = Follower CW* (Follower control word)
 - *61.02 M/F data 2 selection = Used speed reference*
 - *61.03 M/F data 3 selection = Torque reference act 5*
- Data to be read from the followers (optional)
 - *60.14 M/F follower selection* (selection of followers that data is read from)
 - *62.04 Follower node 2 data 1 sel ... 62.12 Follower node 4 data 3 sel* (mapping of data received from followers)

Follower settings:

- Master/follower link activation
 - *60.01 M/F communication port* (XD2D selection)
 - *60.02 M/F node address = 2...60*
 - *60.03 M/F mode = D2D follower*
 - *60.05 M/F HW connection*
- Mapping of data received from master
 - *62.01 M/F data 1 selection = CW 16bit*
 - *62.02 M/F data 2 selection = Ref1 16bit*
 - *62.03 M/F data 3 selection = Ref2 16bit*
- Selection of operating mode and control location
 - *19.12 Ext1 control mode = Speed or Torque*
 - *20.01 Ext1 commands = M/F link*
 - *20.02 Ext1 start trigger type = Level*
- Selection of reference sources
 - *22.11 Speed ref1 source = M/F reference 1*
 - *26.11 Torque ref1 source = M/F reference 2*
- Selection of data to be sent to master (optional)
 - *61.01 M/F data 1 selection = SW 16bit*
 - *61.02 M/F data 2 selection = Act1 16bit*
 - *61.03 M/F data 3 selection = Act2 16bit*

Settings and diagnostics

Parameter groups *60 DDCS communication* (page 357), *61 D2D and DDCS transmit data* (page 366) and *62 D2D and DDCS receive data* (page 370).

External controller interface

Communication

The communication between the master and the follower consists of data sets of three 16-bit words each. The master sends a data set to the follower, which returns the next data set to the master.

The communication uses data sets 10...33. The contents of the data sets are freely configurable, but data set 10 typically contains the control word and one or two references, while data set 11 returns the status word and selected actual values.

The word that is defined as the control word is internally connected to the drive logic; the coding of the bits is as presented in section [Contents of the fieldbus Control word](#) (page 558). Likewise, the coding of the status word is as shown in section [Contents of the fieldbus Status word](#) (page 559).

By default, data sets 32 and 33 are dedicated for the mailbox service, which enables the setting or inquiry of parameter values as follows:

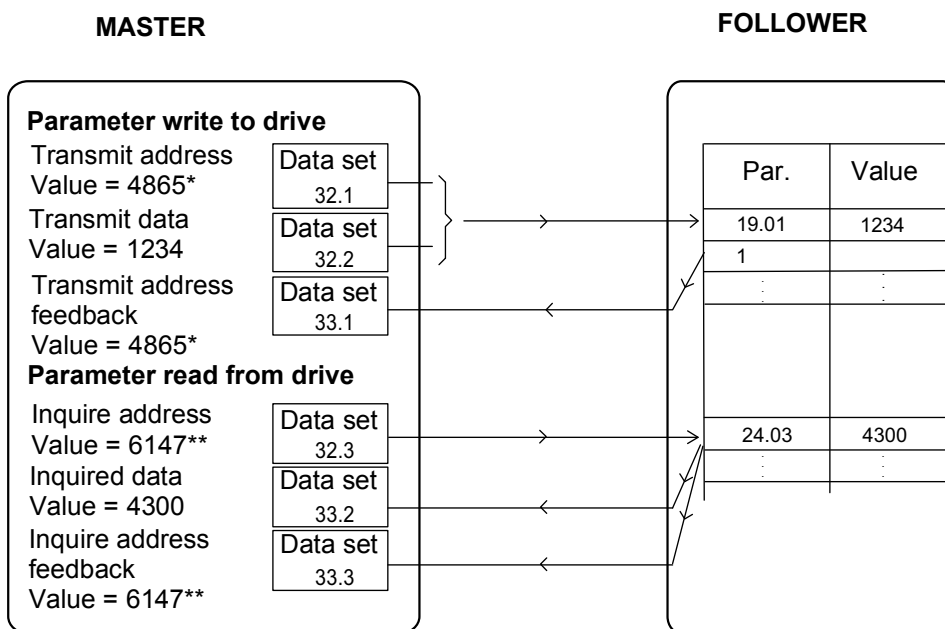

*19.01 -> 13h.01h -> 1301h = 4865

**24.03 -> 18h.03h -> 1803h = 6147

The update intervals of the data sets are as follows:

- Data sets 10...11: 2 ms
- Data sets 12...13: 4 ms
- Data sets 14...17: 10 ms
- Data sets 18...25, 32, 33: 100 ms.

Settings

Parameter groups [60 DDCS communication](#) (page 357), [61 D2D and DDCS transmit data](#) (page 366) and [62 D2D and DDCS receive data](#) (page 370).

Motor control

■ Direct torque control (DTC)

The motor control of the ACS880-M04 is based on direct torque control (DTC), the ABB premium motor control platform. The switching of the output semiconductors is controlled to achieve the required stator flux and motor torque. The switching frequency is changed only if the actual torque and stator flux values differ from their reference values by more than the allowed hysteresis. The reference value for the torque controller comes from the speed controller or directly from an external torque reference source.

Motor control requires measurement of the DC voltage and two motor phase currents. Stator flux is calculated by integrating the motor voltage in vector space. Motor torque is calculated as a cross product of the stator flux and the rotor current. By utilizing the identified motor model, the stator flux estimate is improved. Actual motor shaft speed is not needed for the motor control.

The main difference between traditional control and DTC is that torque control operates at the same time level as the power switch control. There is no separate voltage and frequency controlled PWM modulator; the output stage switching is wholly based on the electromagnetic state of the motor.

The best motor control accuracy is achieved by activating a separate motor identification run (ID run).

See also section [Scalar motor control](#) (page 59).

Settings

Parameters [99.04 Motor control mode](#) (page 426) and [99.13 ID run requested](#) (page 429).

■ Reference ramping

Acceleration and deceleration ramping times can be set individually for speed, torque and frequency reference.

With a speed or frequency reference, the ramps are defined as the time it takes for the drive to accelerate or decelerate between zero speed or frequency and the value defined by parameter [46.01 Speed scaling](#) or [46.02 Frequency scaling](#). The user can switch between two preset ramp sets using a binary source such as a digital input. For speed reference, also the shape of the ramp can be controlled.

With a torque reference, the ramps are defined as the time it takes for the reference to change between zero and nominal motor torque (parameter [01.30 Nominal torque scale](#)).

Special acceleration/deceleration ramps

The acceleration/deceleration times for the jogging function can be defined separately; see section [Jogging](#) (page 57).

The change rate of the motor potentiometer function (page 67) is adjustable. The same rate applies in both directions.

A deceleration ramp can be defined for emergency stop (“Off3” mode).

Settings

- Speed reference ramping: Parameters [23.11...23.19](#) and [46.01](#) (pages [209](#) and [320](#)).
- Torque reference ramping: Parameters [01.30](#), [26.18](#) and [26.19](#) (pages [96](#) and [237](#)).
- Frequency reference ramping: Parameters [28.71...28.75](#) and [46.02](#) (pages [250](#) and [320](#)).
- Jogging: Parameters [23.20](#) and [23.21](#) (page [212](#)).
- Motor potentiometer: Parameter [22.75](#) (page [207](#)).
- Emergency stop (“Off3” mode): Parameter [23.23 Emergency stop time](#) (page [213](#)).

■ Constant speeds/frequencies

Constant speeds and frequencies are predefined references that can be quickly activated, for example, through digital inputs. It is possible to define up to 7 constant speeds for speed control and 7 constant frequencies for frequency control.



WARNING: Constant speeds and frequencies override the normal reference irrespective of where the reference is coming from.

Settings

Parameter groups [22 Speed reference selection](#) (page [198](#)) and [28 Frequency reference chain](#) (page [243](#)).

■ Critical speeds/frequencies

Critical speeds (sometimes called “skip speeds”) can be predefined for applications where it is necessary to avoid certain motor speeds or speed ranges because of, for example, mechanical resonance problems.

The critical speeds function prevents the reference from dwelling within a critical band for extended times. When a changing reference ([22.87 Speed reference act 7](#)) enters a critical range, the output of the function ([22.01 Speed ref unlimited](#)) freezes until the reference exits the range. Any instant change in the output is smoothed out by the ramping function further in the reference chain.

The function is also available for scalar motor control with a frequency reference. The input of the function is shown by [28.96 Frequency ref act 7](#), the output by [28.97 Frequency ref unlimited](#).

Example

A fan has vibrations in the range of 540 to 690 rpm and 1380 to 1560 rpm. To make the drive avoid these speed ranges,

- enable the critical speeds function by turning on bit 0 of parameter [22.51 Critical speed function](#), and
- set the critical speed ranges as in the figure below.

[22.01 Speed ref unlimited](#) (rpm)
(output of function)

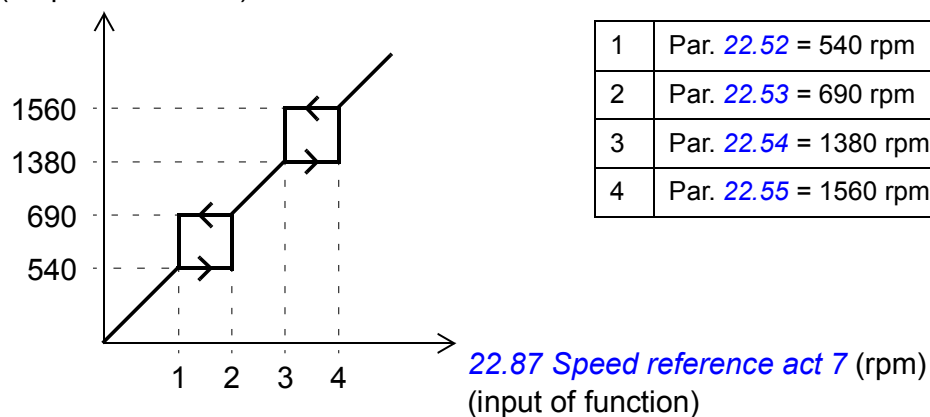

Settings

- Critical speeds: parameters [22.51](#)...[22.57](#) (page [204](#))
- Critical frequencies: parameters [28.51](#)...[28.57](#) (page [249](#)).

■ Speed controller autotune

The speed controller of the drive can be automatically adjusted using the autotune function. Autotuning is based on an estimation of the mechanical time constant (inertia) of the motor and machine.

The autotune routine will run the motor through a series of acceleration/deceleration cycles, the number of which can be adjusted by parameter [25.40 Autotune repeat times](#). Higher values will produce more accurate results, especially if the difference between initial and maximum speeds is small.

The maximum torque reference used during autotuning will be the initial torque (ie. torque when the routine is activated) plus [25.38 Autotune torque step](#), unless limited by the maximum torque limit (parameter group [30 Limits](#)) or the nominal motor torque ([99 Motor data](#)). The calculated maximum speed during the routine is the initial speed (ie. speed when the routine is activated) + [25.39 Autotune speed step](#), unless limited by [30.12 Maximum speed](#) or [99.09 Motor nominal speed](#).

The diagram below shows the behavior of speed and torque during the autotune routine. In this example, [25.40 Autotune repeat times](#) is set to 2.

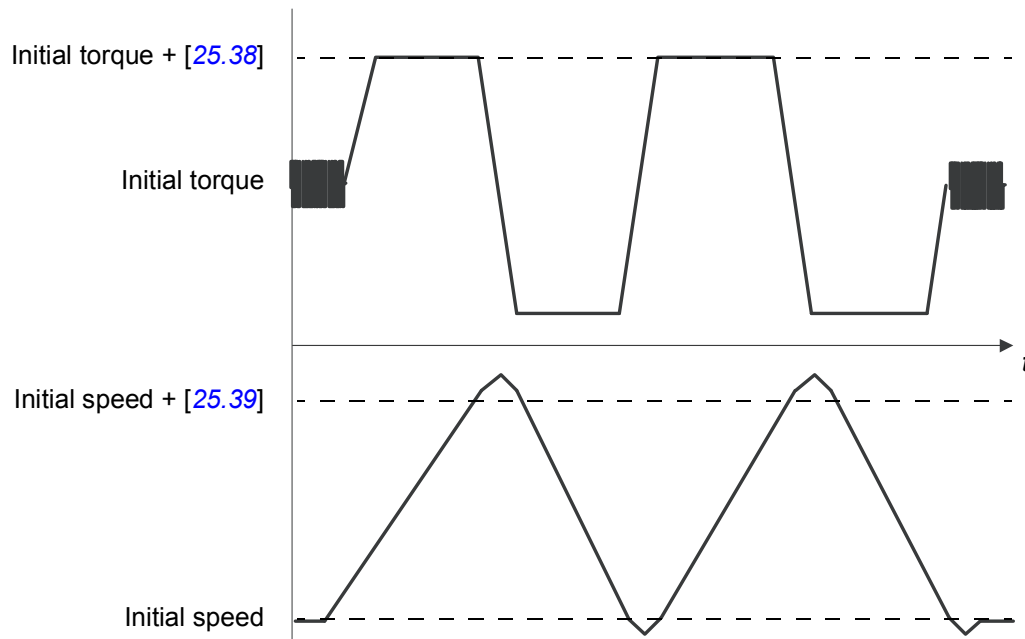

Notes:

- If the drive cannot produce the requested braking power during the routine, the results will be based on the acceleration stages only, and not as accurate as with full braking power.
- The motor will exceed the calculated maximum speed slightly at the end of each acceleration stage.

Before activating the autotune routine

The prerequisites for performing the autotune routine are:

- The motor identification run (ID run) has been successfully completed
- Speed and torque limits (parameter group [30 Limits](#)) have been set
- The speed feedback has been monitored for noise, vibrations and other disturbances caused by the mechanics of the system, and
 - speed feedback filtering (parameter group [90 Feedback selection](#))
 - speed error filtering ([24 Speed reference conditioning](#)) and
 - zero speed (parameters [21.06](#) and [21.07](#))
 have been set to eliminate these disturbances.
- The drive has been started and is running in speed control mode.

After these conditions have been fulfilled, autotuning can be activated by parameter [25.33 Speed controller autotune](#) (or the signal source selected by it).

Autotune modes

Autotuning can be performed in three different ways depending on the setting of parameter [25.34 Speed controller autotune mode](#). The selections *Smooth*, *Normal* and *Tight* define how the drive torque reference should react to a speed reference step after tuning. The selection *Smooth* will produce a slow but robust response; *Tight* will produce a fast response but possibly too high gain values for some applications. The figure below shows speed responses at a speed reference step (typically 1...20%).

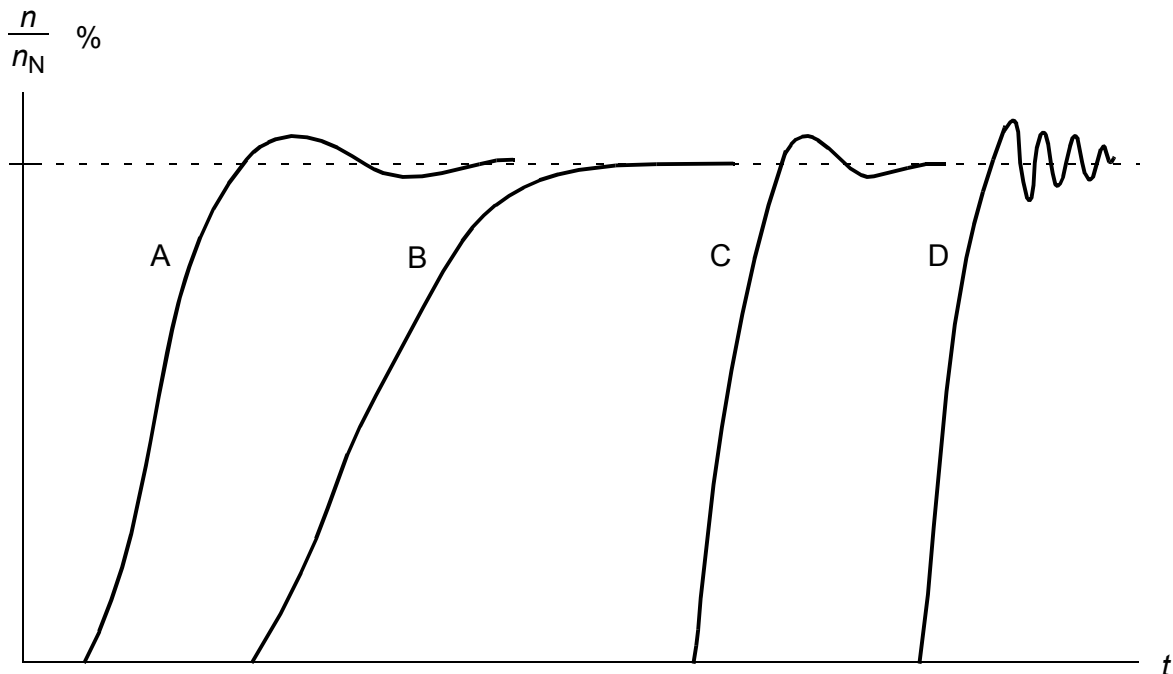

- A: Undercompensated
- B: Normally tuned (autotuning)
- C: Normally tuned (manually). Better dynamic performance than with B
- D: Overcompensated speed controller

Autotune results

At the end of a successful autotune routine, its results are automatically transferred into parameters

- [25.02 Speed proportional gain](#) (proportional gain of the speed controller)
- [25.03 Speed integration time](#) (integration time of the speed controller)
- [25.37 Mechanical time constant](#) (mechanical time constant of the motor and machine).

Nevertheless, it is still possible to manually adjust the controller gain, integration time and derivation time.

The figure below is a simplified block diagram of the speed controller. The controller output is the reference for the torque controller.

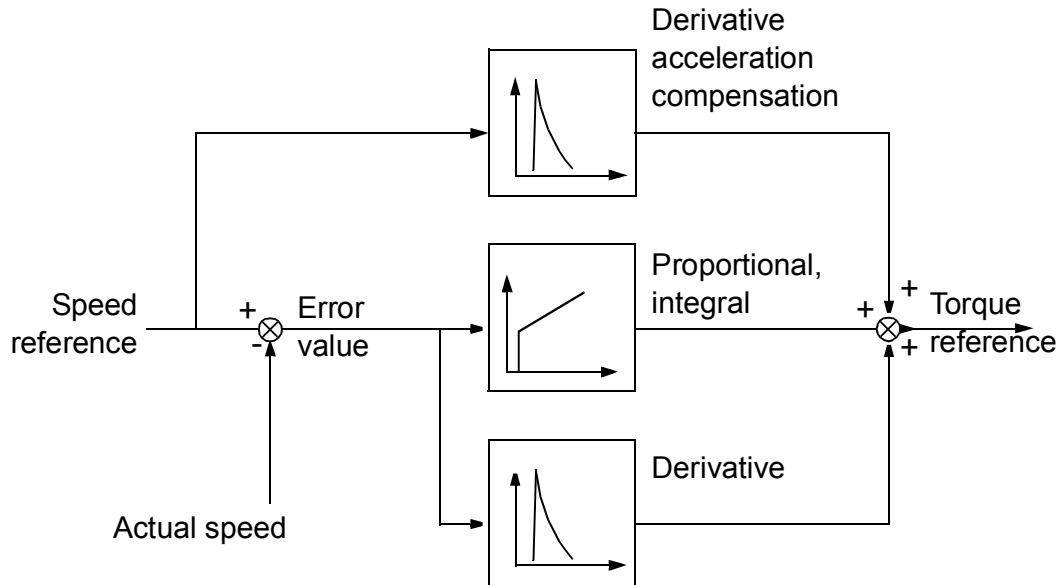

Warning indications

A warning message, [AF90 Speed controller autotuning](#), will be generated if the autotune routine does not complete successfully. See chapter [Fault tracing](#) (page 479) for further information.

Settings

Parameters [25.33...25.40](#) (page 232).

■ Oscillation damping

The oscillation damping function can be used to cancel out oscillations caused by mechanics or an oscillating DC voltage. The input – a signal reflecting the oscillation – is selected by parameter [26.53 Oscillation compensation input](#). The oscillation damping function outputs a sine wave ([26.58 Oscillation damping output](#)) which can be summed with the torque reference with a suitable gain ([26.57 Oscillation damping gain](#)) and phase shift ([26.56 Oscillation damping phase](#)).

The oscillation damping algorithm can be activated without connecting the output to the reference chain, which makes it possible to compare the input and output of the function and make further adjustments before applying the result.

Tuning procedure for oscillation damping

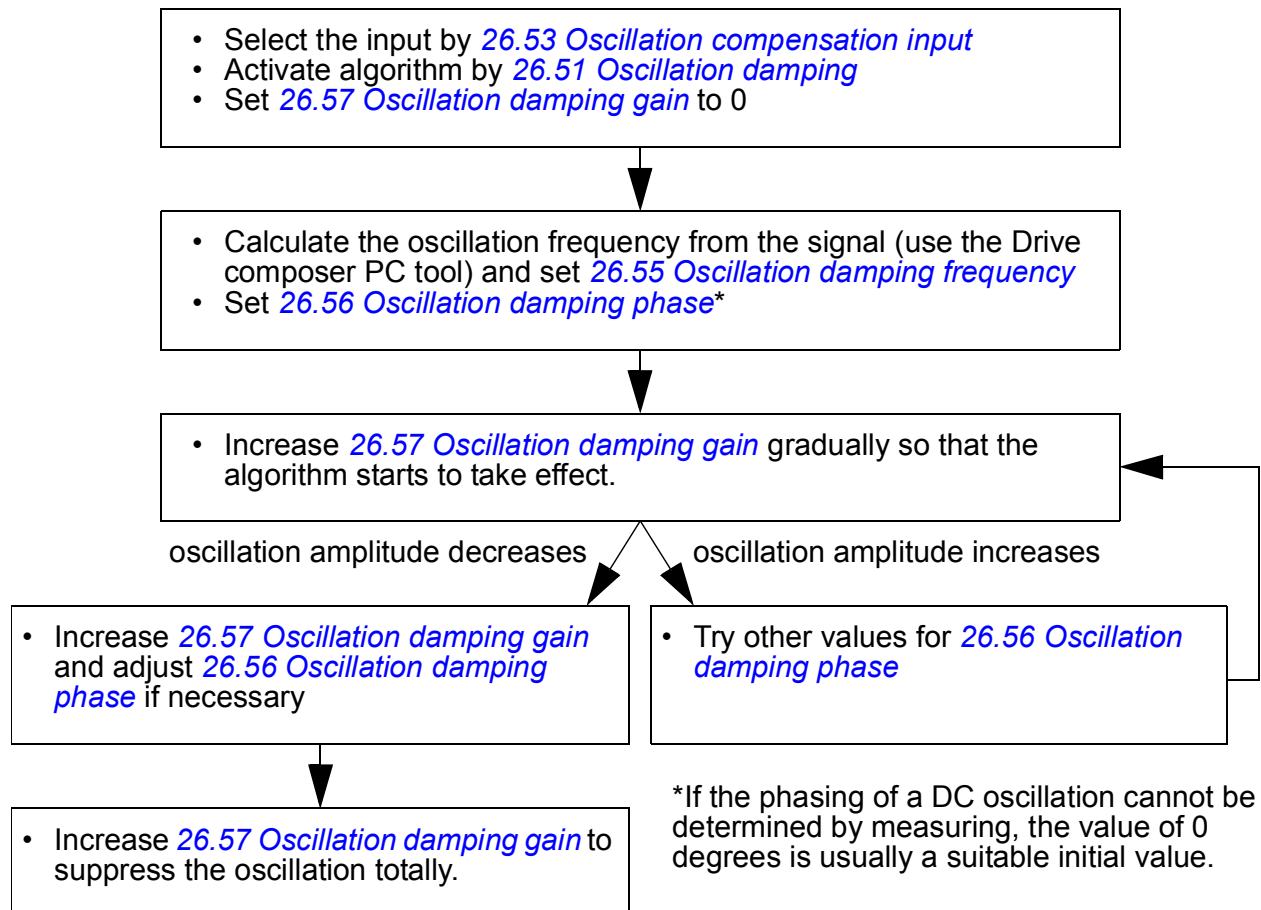

Note: Changing the speed error low-pass filter time constant or the integration time of the speed controller can affect the tuning of the oscillation damping algorithm. It is recommended to tune the speed controller before the oscillation damping algorithm. (The speed controller gain can be adjusted after the tuning of this algorithm.)

Settings

Parameters [26.51](#)...[26.58](#) (page [239](#)).

■ Rush control

In torque control, the motor could potentially rush if the load were suddenly lost. The control program has a rush control function that decreases the torque reference whenever the motor speed exceeds [30.11 Minimum speed](#) or [30.12 Maximum speed](#).

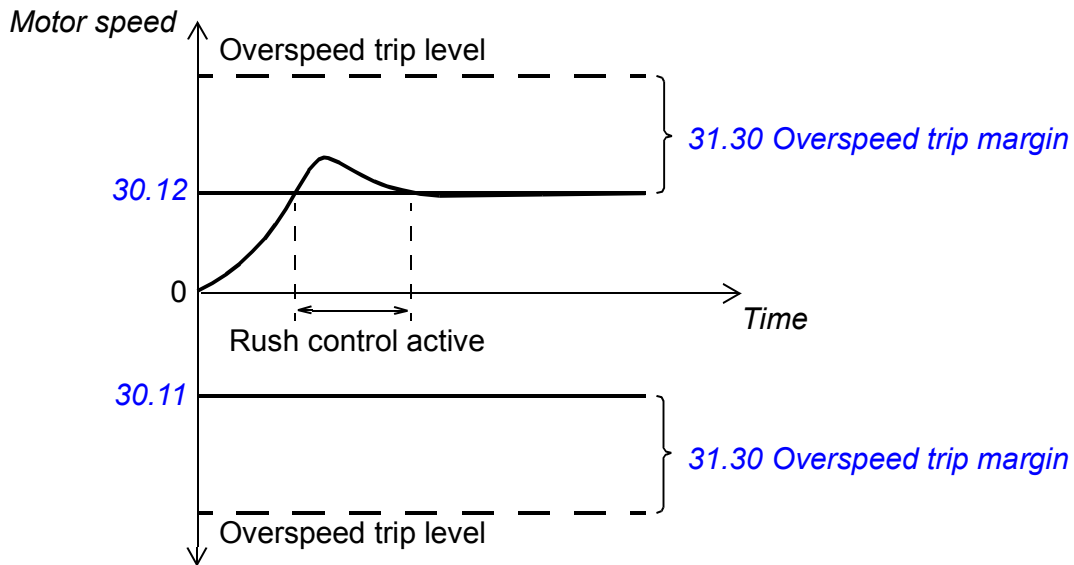

The function is based on a PI controller. The proportional gain and integration time can be defined by parameters. Setting these to zero disables rush control.

Settings

Parameters [26.81 Rush control gain](#) and [26.82 Rush control integration time](#) (page [243](#)).

Encoder support

The program supports two single-turn or multiturn encoders (or resolvers). The following optional interface modules are available:

- TTL encoder interface FEN-01: two TTL inputs, TTL output (for encoder emulation and echo) and two digital inputs
- Absolute encoder interface FEN-11: absolute encoder input, TTL input, TTL output (for encoder emulation and echo) and two digital inputs
- Resolver interface FEN-21: resolver input, TTL input, TTL output (for encoder emulation and echo) and two digital inputs
- HTL encoder interface FEN-31: HTL encoder input, TTL output (for encoder emulation and echo) and two digital inputs
- HTL/TTL encoder interface FSE-31 (for use with an FSO-xx safety functions module): Two HTL/TTL encoder inputs.

Install the interface module onto one of the option slots on the drive control unit.

Encoder echo and emulation

Both encoder echo and emulation are supported by the above-mentioned FEN-xx interfaces.

Encoder echo is available with TTL, TTL+ and HTL encoders. The signal received from the encoder is relayed to the TTL output unchanged. This enables the connection of one encoder to several drives.

Encoder emulation also relays the encoder signal to the output, but the signal is either scaled, or position data converted to pulses. Emulation can be used when absolute encoder or resolver position needs to be converted to TTL pulses, or when the signal must be converted to a different pulse number than the original.

Quick configuration of HTL encoder feedback

1. Specify the type of the encoder interface module (parameter [91.11 Module 1 type](#) = [FEN-31](#)) and the slot the module is installed into ([91.12 Module 1 location](#)).
 2. Specify the type of the encoder ([92.01 Encoder 1 type](#) = [HTL](#)). The parameter listing will be re-read from the drive after the value is changed.
 3. Specify the interface module that the encoder is connected to ([92.02 Encoder 1 source](#) = [Module 1](#)).
 4. Set the number of pulses according to encoder nameplate ([92.10 Pulses/revolution](#)).
 5. If the encoder rotates at a different speed to the motor (ie. is not mounted directly on the motor shaft), enter the gear ratio in [90.43 Motor gear numerator](#) and [90.44 Motor gear denominator](#).
 6. Set parameter [91.10 Encoder parameter refresh](#) to [Refresh](#) to apply the new parameter settings. The parameter will automatically revert to [Done](#).
 7. Check that [91.02 Module 1 status](#) is showing the correct interface module type ([FEN-31](#)). Also check the status of the module; both LEDs should be glowing green.
 8. Start the motor with a reference of eg. 400 rpm.
 9. Compare the estimated speed ([01.02 Motor speed estimated](#)) with the measured speed ([01.04 Encoder 1 speed filtered](#)). If the values are the same, set the encoder as the feedback source ([90.41 Motor feedback selection](#) = [Encoder 1](#)).
 10. Specify the action taken in case the feedback signal is lost ([90.45 Motor feedback fault](#)).
-

Position counter

The control program contains a position counter feature that can be used to indicate the position of a load, eg. the position of a conveyor belt or the height of the load on a crane. The output of the counter function, parameter [90.07 Load position scaled int](#), indicates the scaled number of revolutions read from an encoder through either encoder interface. A position estimate calculated internally by the motor control can be used instead of encoder feedback. (The estimate is also used until next stop if the selected feedback is lost and its monitoring parameter is set to warning instead of fault.)

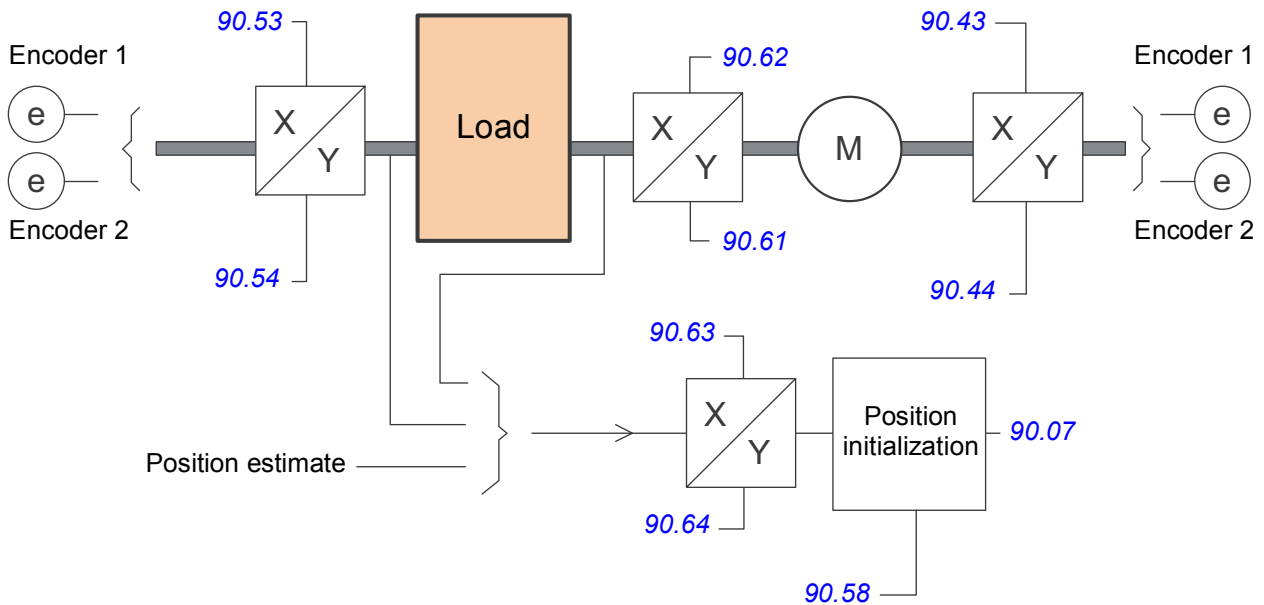

The source of the measurement is selected by [90.51 Load feedback selection](#). Any gear ratio between the encoder and load is defined by [90.53 Load gear numerator](#) and [90.54 Load gear denominator](#). In case the internal position estimate is chosen as the source, the gear between the motor and load must be defined in [90.61 Gear numerator](#) and [90.62 Gear denominator](#).

The relation between revolutions of the motor shaft and the translatory movement of the load (in any given unit of distance) is defined by parameters [90.63 Feed constant numerator](#) and [90.64 Feed constant denominator](#).

By default, all of the ratios mentioned above are 1:1.

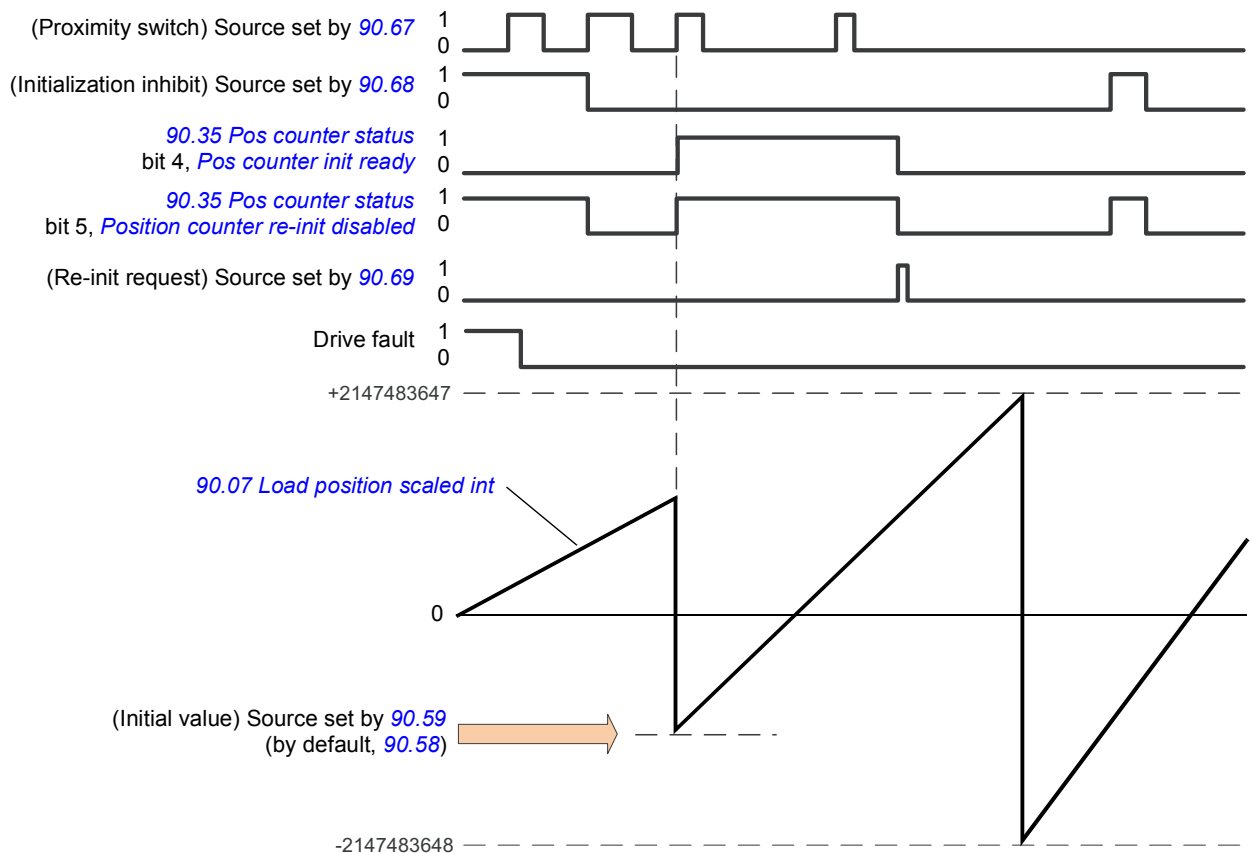

The position counter is initialized by setting a known physical position of the load into the control program. The initial position (for example, the home/zero position, or the distance from it) can be entered manually in a parameter (*90.58 Pos counter init value int*), or taken from another parameter. This position is set as the value of the position counter (*90.07 Load position scaled int*) when the source selected by *90.67 Pos counter init cmd source*, such as a proximity switch connected to a digital input, is activated. A successful initialization is indicated by bit 4 of *90.35 Pos counter status*.

Any subsequent initialization of the counter must first be enabled by *90.69 Reset pos counter init ready*. To define a time window for initializations, *90.68 Disable pos counter initialization* can be used to inhibit the signal from the proximity switch. An active fault in the drive will also prevent counter initialization.

See also the block diagram on page 570.

Reading/writing position counter values through fieldbus

The parameters of the position counter function, such as *90.07 Load position scaled int* and *90.58 Pos counter init value int*, can be accessed from an upper-level control system in the following formats:

- 16-bit integer (if 16 bits are sufficient for the application)
- 32-bit integer (can be accessed as two consequent 16-bit words).

For example, to read parameter [90.07 Load position scaled int](#) through fieldbus, set the selection parameter of the desired dataset (in group 52) to *Other – 90.07*, and select the format. If you select a 32-bit format, the subsequent data word is also automatically reserved.

Example: ACS 600 / ACS800 compatibility

With ACS 600 and ACS800 drives, both the rising and falling edges from encoder channels A and B are typically counted to achieve best possible accuracy. Thus the received pulse number per revolution equals four times the nominal pulse number of the encoder.

In this example, an HTL-type 2048-pulse encoder is fitted directly on the motor shaft. The desired initial position to correspond the proximity switch is 66770.

In the ACS880-M04, the following settings are made:

- [92.01 Encoder 1 type](#) = HTL
- [92.02 Encoder 1 source](#) = Module 1
- [92.10 Pulses/revolution](#) = 2048
- [92.13 Position estimation enable](#) = Enable
- [90.51 Load feedback selection](#) = Encoder 1
- [90.63 Feed constant numerator](#) = 8192 (ie. 4 × value of [92.10](#), as the received number of pulses is 4 times nominal. See also parameter [92.12 Resolver polepairs](#))
- The desired “data out” parameter is set to Other – [90.58 Pos counter init value int](#) (32-bit format). Only the high word needs to be specified – the subsequent data word is reserved for the low word automatically.
- The desired sources (such as digital inputs or user bits of the control word) are selected in [90.67 Pos counter init cmd source](#) and [90.69 Reset pos counter init ready](#).

In the PLC, if the initial value is set in 32-bit format using low and high words (corresponding to ACS800 parameters POS COUNT INIT LO and POS COUNT INIT HI), enter the value 66770 into these words as follows:

Eg. PROFIBUS:

- FBA data out x = POS COUNT INIT HI = 1 (as bit 16 equals 66536)
- FBA data out (x + 1) = POS COUNT INIT LO = 1234.

ABB Automation using DDCS communication, eg.:

- Data set 12.1 = POS COUNT INIT HI
- Data set 12.2 = POS COUNT INIT LO

To test the configuration of the PLC, initialize the position counter with the encoder connected. The initial value sent from the PLC should immediately be reflected by [90.07 Load position scaled int](#) in the drive. The same value should then appear in the PLC after having been read from the drive.

Settings

Parameter groups [90 Feedback selection](#) (page 379), [91 Encoder module settings](#) (page 391), [92 Encoder 1 configuration](#) (page 395) and [93 Encoder 2 configuration](#) (page 403).

■ Jogging

The jogging function enables the use of a momentary switch to briefly rotate the motor. The jogging function is typically used during servicing or commissioning to control the machinery locally.

Two jogging functions (1 and 2) are available, each with their own activation sources and references. The signal sources are selected by parameters [20.26 Jogging 1 start source](#) and [20.27 Jogging 2 start source](#). When jogging is activated, the drive starts and accelerates to the defined jogging speed ([22.42 Jogging 1 ref](#) or [22.43 Jogging 2 ref](#)) along the defined jogging acceleration ramp ([23.20 Acc time jogging](#)). After the activation signal switches off, the drive decelerates to a stop along the defined jogging deceleration ramp ([23.21 Dec time jogging](#)).

The figure and table below provide an example of how the drive operates during jogging. In the example, the ramp stop mode is used (see parameter [21.03 Stop mode](#)).

Jog cmd = State of source set by [20.26 Jogging 1 start source](#) or [20.27 Jogging 2 start source](#)

Jog enable = State of source set by [20.25 Jogging enable](#)

Start cmd = State of drive start command.

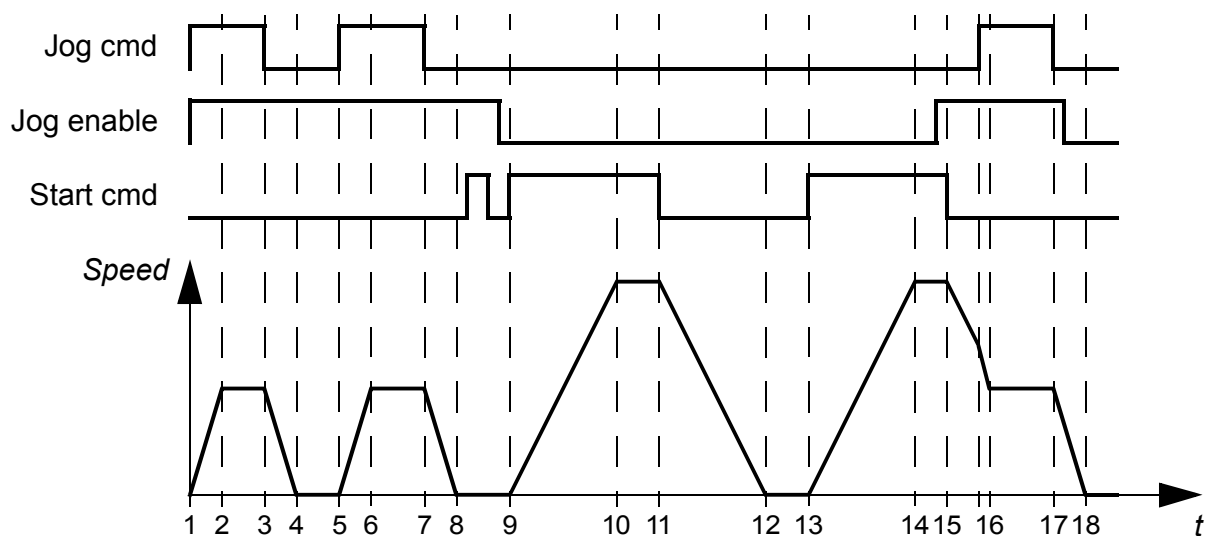

Phase	Jog cmd	Jog enable	Start cmd	Description
1-2	1	1	0	Drive accelerates to the jogging speed along the acceleration ramp of the jogging function.

Phase	Jog cmd	Jog enable	Start cmd	Description
2-3	1	1	0	Drive follows the jog reference.
3-4	0	1	0	Drive decelerates to zero speed along the deceleration ramp of the jogging function.
4-5	0	1	0	Drive is stopped.
5-6	1	1	0	Drive accelerates to the jogging speed along the acceleration ramp of the jogging function.
6-7	1	1	0	Drive follows the jog reference.
7-8	0	1	0	Drive decelerates to zero speed along the deceleration ramp of the jogging function.
8-9	0	1->0	0	Drive is stopped. As long as the jog enable signal is on, start commands are ignored. After jog enable switches off, a fresh start command is required.
9-10	x	0	1	Drive accelerates to the speed reference along the selected acceleration ramp (parameters 23.11 ... 23.19).
10-11	x	0	1	Drive follows the speed reference.
11-12	x	0	0	Drive decelerates to zero speed along the selected deceleration ramp (parameters 23.11 ... 23.19).
12-13	x	0	0	Drive is stopped.
13-14	x	0	1	Drive accelerates to the speed reference along the selected acceleration ramp (parameters 23.11 ... 23.19).
14-15	x	0->1	1	Drive follows the speed reference. As long as the start command is on, the jog enable signal is ignored. If the jog enable signal is on when the start command switches off, jogging is enabled immediately.
15-16	0->1	1	0	Start command switches off. The drive starts to decelerate along the selected deceleration ramp (parameters 23.11 ... 23.19). When the jog command switches on, the decelerating drive adopts the deceleration ramp of the jogging function.
16-17	1	1	0	Drive follows the jog reference.
17-18	0	1->0	0	Drive decelerates to zero speed along the deceleration ramp of the jogging function.

See also the block diagram on page [568](#).

Notes:

- Jogging is not available when the drive is in local control.
- Jogging cannot be enabled when the drive start command is on, or the drive started when jogging is enabled. Starting the drive after the jog enable switches off requires a fresh start command.



WARNING! If jogging is enabled and activated while the start command is on, jogging will activate as soon as the start command switches off.

- If both jogging functions are activated, the one that was activated first has priority.
- Jogging uses the speed control mode.
- Ramp shape times (parameters [23.16](#)...[23.19](#)) do not apply to jogging acceleration/deceleration ramps.
- The inching functions activated through fieldbus (see [06.01 Main control word](#), bits 8...9) use the references and ramp times defined for jogging, but do not require the jog enable signal.

Settings

Parameters [20.25 Jogging enable](#) (page 186), [20.26 Jogging 1 start source](#) (page 187), [20.27 Jogging 2 start source](#) (page 187), [22.42 Jogging 1 ref](#) (page 204), [22.43 Jogging 2 ref](#) (page 204), [23.20 Acc time jogging](#) (page 212) and [23.21 Dec time jogging](#) (page 212).

■ Scalar motor control

It is possible to select scalar control as the motor control method instead of DTC (Direct Torque Control). In scalar control mode, the drive is controlled with a speed or frequency reference. However, the outstanding performance of DTC is not achieved in scalar control.

It is recommended to activate scalar motor control mode

- if the nominal current of the motor is less than 1/6 of the nominal output current of the drive
- if the drive is used without a motor connected (for example, for test purposes)
- if the drive runs a medium-voltage motor through a step-up transformer, or
- in multimotor drives, if
 - the load is not equally shared between the motors,
 - the motors are of different sizes, or
 - the motors are going to be changed after motor identification (ID run)

In scalar control, some standard features are not available.

See also section [Operating modes of the drive](#) (page 28).

IR compensation for scalar motor control

IR compensation (also known as voltage boost) is available only when the motor control mode is scalar. When IR compensation is activated, the drive gives an extra voltage boost to the motor at low speeds. IR compensation is useful in applications that require a high break-away torque. In step-up applications, voltage cannot be fed through the transformer at 0 Hz, so an additional breakpoint is available for defining the compensation near zero frequency.

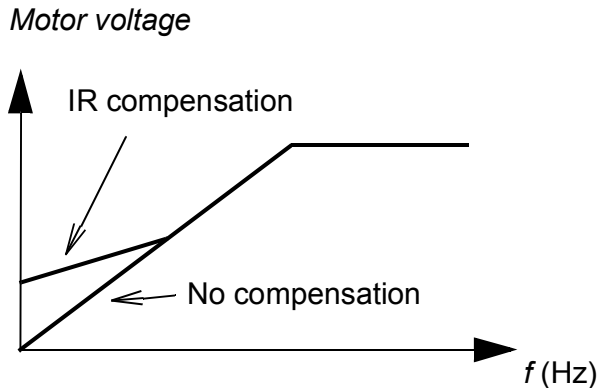

In Direct Torque Control (DTC), no IR compensation is possible or needed as it is applied automatically.

Settings

- Parameters [19.20 Scalar control reference unit](#) (page 175), [97.12 IR comp step-up frequency](#) (page 421), [97.13 IR compensation](#) (page 422) and [99.04 Motor control mode](#) (page 426)
- Parameter group [28 Frequency reference chain](#) (page 243).

Autophasing

Autophasing is an automatic measurement routine to determine the angular position of the magnetic flux of a permanent magnet synchronous motor or the magnetic axis of a synchronous reluctance motor. The motor control requires the absolute position of the rotor flux in order to control motor torque accurately.

Sensors like absolute encoders and resolvers indicate the rotor position at all times after the offset between the zero angle of rotor and that of the sensor has been established. On the other hand, a standard pulse encoder determines the rotor position when it rotates but the initial position is not known. However, a pulse encoder can be used as an absolute encoder if it is equipped with Hall sensors, albeit with coarse initial position accuracy. Hall sensors generate so-called commutation pulses that change their state six times during one revolution, so it is only known within which 60° sector of a complete revolution the initial position is.

Many encoders give a zero pulse (also called Z-pulse) once during each rotation. The position of the zero pulse is fixed. If this position is known with respect to zero position used by motor control, the rotor position at the instant of the zero pulse is also known.

Using the zero pulse improves the robustness of the rotor position measurement. The rotor position must be determined during starting because the initial value given by the encoder is zero. The autophasing routine determines the position, but there is a

risk of some position error. If the zero pulse position is known in advance, the position found by autophasing can be corrected as soon as the zero pulse is detected for the first time after starting.

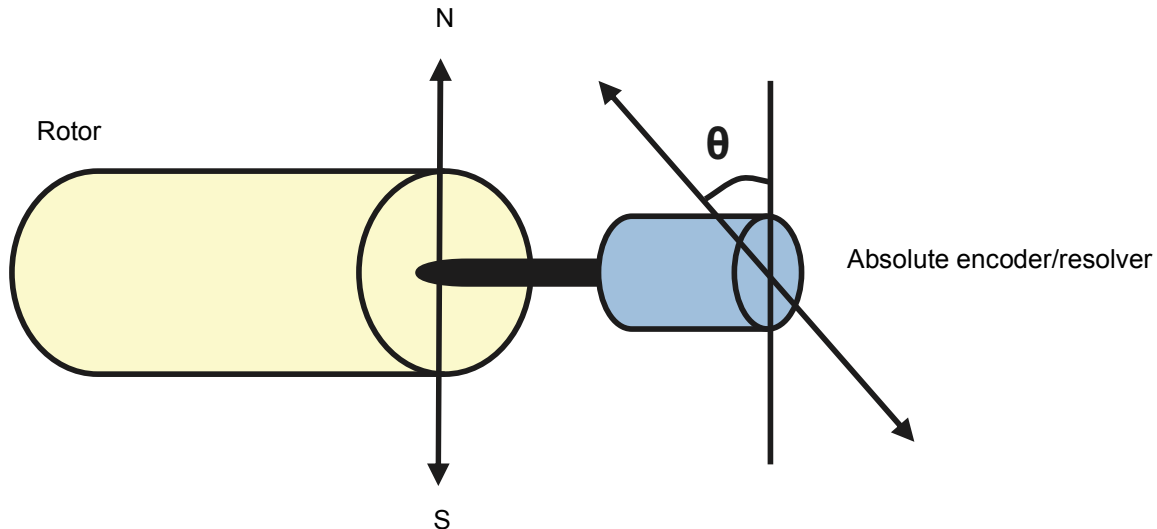

The autophasing routine is performed with permanent magnet synchronous motors and synchronous reluctance motors in the following cases:

1. One-time measurement of the rotor and encoder position difference when an absolute encoder, a resolver, or an encoder with commutation signals is used
2. At every power-up when an incremental encoder is used
3. With open-loop motor control, repetitive measurement of the rotor position at every start
4. When the position of the zero pulse must be measured before the first start after power-up.

Note: In closed-loop control, autophasing is performed automatically after the motor identification run (ID run). Autophasing is also performed automatically before starting when necessary.

In open-loop control, the zero angle of the rotor is determined before starting. In closed-loop control, the actual angle of the rotor is determined with autophasing when the sensor indicates zero angle. The offset of the angle must be determined because the actual zero angles of the sensor and the rotor do not usually match. The autophasing mode determines how this operation is done both in open-loop and closed-loop control.

The rotor position offset used in motor control can also be given by the user – see parameter [98.15 Position offset user](#). Note that the autophasing routine also writes its result into this parameter. The results are updated even if user settings are not enabled by [98.01 User motor model mode](#).

Note: In open-loop control, the motor always turns when it is started as the shaft is turned towards the remanence flux.

Autophasing modes

Several autophasing modes are available (see parameter [21.13 Autophasing mode](#)).

The turning mode ([Turning](#)) is recommended especially with case 1 (see the list above) as it is the most robust and accurate method. In turning mode, the motor shaft is turned back and forward ($\pm 360/\text{polepairs}$)° in order to determine the rotor position. In case 3 (open-loop control), the shaft is turned only in one direction and the angle is smaller.

Another turning mode, [Turning with Z-pulse](#), can be used if there is difficulty using the normal turning mode, for example, because of significant friction. With this mode, the rotor is turned slowly until a zero pulse is detected from the encoder. When the zero pulse is detected for the first time, its position is stored into parameter [98.15 Position offset user](#), which can be edited for fine-tuning. Note that it is not mandatory to use this mode with a zero pulse encoder. In open-loop control, the two turning modes are identical.

The standstill modes ([Standstill 1](#), [Standstill 2](#)) can be used if the motor cannot be turned (for example, when the load is connected). As the characteristics of motors and loads differ, testing must be done to find out the most suitable standstill mode.

The drive is capable of determining the rotor position when started into a running motor in open-loop or closed-loop control. In this situation, the setting of [21.13 Autophasing mode](#) has no effect.

The autophasing routine can fail and therefore it is recommended to perform the routine several times and check the value of parameter [98.15 Position offset user](#).

An autophasing fault ([3385 Autophasing](#)) can occur with a running motor if the estimated angle of the motor differs too much from the measured angle. This could be caused by, for example, the following:

- The encoder is slipping on the motor shaft
- An incorrect value has been entered into [98.15 Position offset user](#)
- The motor is already turning before the autophasing routine is started
- [Turning](#) mode is selected in [21.13 Autophasing mode](#) but the motor shaft is locked
- [Turning with Z-pulse](#) mode is selected in [21.13 Autophasing mode](#) but no zero pulse is detected within a revolution of the motor
- The wrong motor type is selected in [99.03 Motor type](#)
- Motor ID run has failed.

Settings

Parameters [21.13 Autophasing mode](#) (page 195), [98.15 Position offset user](#) (page 425) and [99.13 ID run requested](#) (page 429).

■ Flux braking

The drive can provide greater deceleration by raising the level of magnetization in the motor. By increasing the motor flux, the energy generated by the motor during braking can be converted to motor thermal energy.

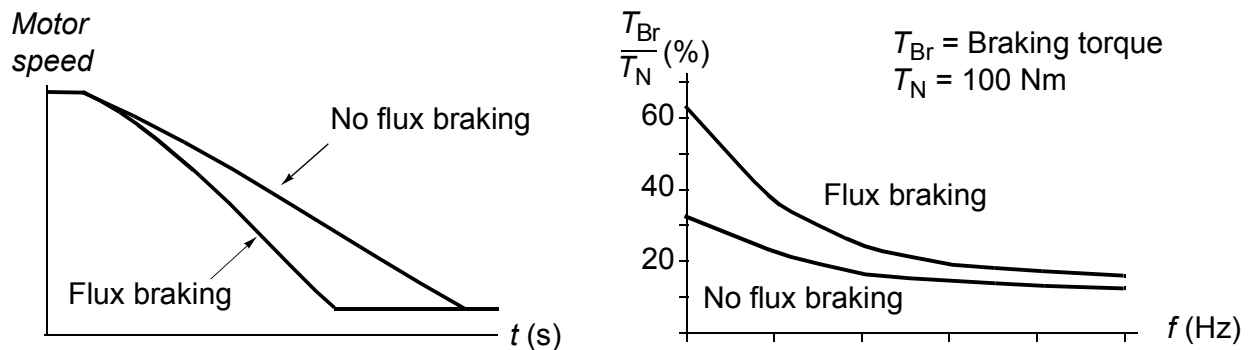

The drive monitors the motor status continuously, also during flux braking. Therefore, flux braking can be used both for stopping the motor and for changing the speed. The other benefits of flux braking are:

- The braking starts immediately after a stop command is given. The function does not need to wait for the flux reduction before it can start the braking.
- The cooling of the induction motor is efficient. The stator current of the motor increases during flux braking, not the rotor current. The stator cools much more efficiently than the rotor.
- Flux braking can be used with induction motors and permanent magnet synchronous motors.

Two braking power levels are available:

- Moderate braking provides faster deceleration compared to a situation where flux braking is disabled. The flux level of the motor is limited to prevent excessive heating of the motor.
- Full braking exploits almost all available current to convert the mechanical braking energy to motor thermal energy. Braking time is shorter compared to moderate braking. In cyclic use, motor heating may be significant.



WARNING: The motor needs to be rated to absorb the thermal energy generated by flux braking.

Settings

Parameter [97.05 Flux braking](#) (page 419).

■ DC magnetization

DC magnetization can be applied to the motor to

- heat the motor to remove or prevent condensation, or
- to lock the rotor at, or near, zero speed.

Pre-heating

A motor pre-heating function is available to prevent condensation in a stopped motor, or to remove condensation from the motor before start. Pre-heating involves feeding a DC current into the motor to heat up the windings.

Pre-heating is deactivated at start, or when one of the other DC magnetization functions is activated. With the drive stopped, pre-heating is disabled by the safe torque off function, or a drive fault state. Pre-heating can only start after one minute has elapsed from stopping the drive.

A digital source to control pre-heating is selected by parameter [21.14 Pre-heating input source](#). The heating current is set by [21.16 Pre-heating current](#).

Pre-magnetization

Pre-magnetization refers to DC magnetization of the motor before start. Depending on the selected start mode ([21.01 Start mode](#) or [21.19 Scalar start mode](#)), pre-magnetization can be applied to guarantee the highest possible breakaway torque, up to 200% of the nominal torque of the motor. By adjusting the pre-magnetization time ([21.02 Magnetization time](#)), it is possible to synchronize the motor start and, for example, the release of a mechanical brake.

DC hold

The function makes it possible to lock the rotor at (near) zero speed in the middle of normal operation. DC hold is activated by parameter [21.08 DC current control](#). When both the reference and motor speed drop below a certain level (parameter [21.09 DC hold speed](#)), the drive will stop generating sinusoidal current and start to inject DC into the motor. The current is set by parameter [21.10 DC current reference](#). When the reference exceeds parameter [21.09 DC hold speed](#), normal drive operation continues.

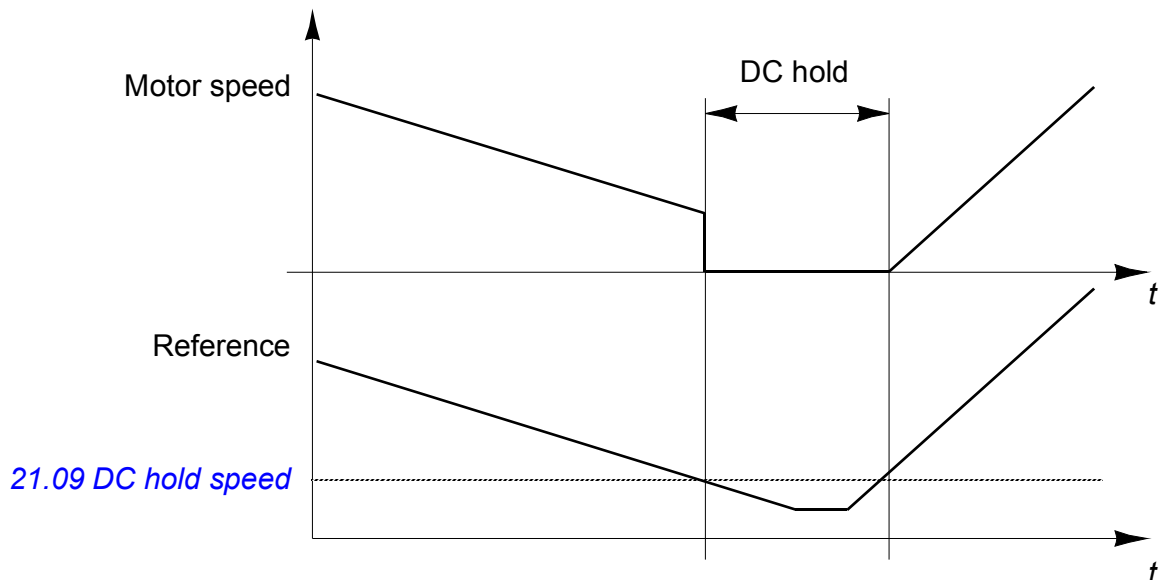
**Notes:**

- DC hold is only available in speed control in DTC motor control mode (see page 28).
- The function applies the DC current to one phase only, depending on the position of the rotor. The return current will be shared between the other phases.

Post-magnetization

This feature keeps the motor magnetized for a certain period (parameter [21.11 Post magnetization time](#)) after stopping. This is to prevent the machinery from moving under load, for example before a mechanical brake can be applied. Post-magnetization is activated by parameter [21.08 DC current control](#). The magnetization current is set by parameter [21.10 DC current reference](#).

Note: Post-magnetization is only available in speed control in DTC motor control mode (see page 28), and only when ramping is the selected stop mode (see parameter [21.03 Stop mode](#)).

Continuous magnetization

A digital signal, such as a user bit in the fieldbus control word, can be selected to activate continuous magnetization. This can be especially useful in processes requiring motors to be stopped (for example, to stand by until new material is processed), then quickly started without magnetizing them first.

Note: Continuous magnetization is only available in speed control in DTC motor control mode (see page 28), and only when ramping is the selected stop mode (see parameter [21.03 Stop mode](#)).



WARNING: The motor must be designed to absorb or dissipate the thermal energy generated by continuous magnetization, for example by forced ventilation.

Settings

Parameters [06.21 Drive status word 3](#) (page 113), [21.01 Start mode](#), [21.01 Start mode](#), [21.02 Magnetization time](#), [21.08...21.12](#), [21.14 Pre-heating input source](#) and [21.16 Pre-heating current](#) (page 188).

Application control

■ Application macros

Application macros are predefined application parameter edits and I/O configurations. See chapter [Application macros](#) (page 85).

■ Motor potentiometer

The motor potentiometer is, in effect, a counter whose value can be adjusted up and down using two digital signals selected by parameters [22.73 Motor potentiometer up source](#) and [22.74 Motor potentiometer down source](#). Note that these signals have no effect when the drive is stopped.

When enabled by [22.71 Motor potentiometer function](#), the motor potentiometer assumes the value set by [22.72 Motor potentiometer initial value](#). Depending on the mode selected in [22.71](#), the motor potentiometer value is either retained or reset over a stop or a power cycle.

The change rate is defined in [22.75 Motor potentiometer ramp time](#) as the time it would take for the value to change from the minimum ([22.76 Motor potentiometer min value](#)) to the maximum ([22.77 Motor potentiometer max value](#)) or vice versa. If the up and down signals are simultaneously on, the motor potentiometer value does not change.

The output of the function is shown by [22.80 Motor potentiometer ref act](#), which can directly be set as the source of any selector parameter such as [22.11 Speed ref1 source](#).

The following example shows the behavior of the motor potentiometer value.

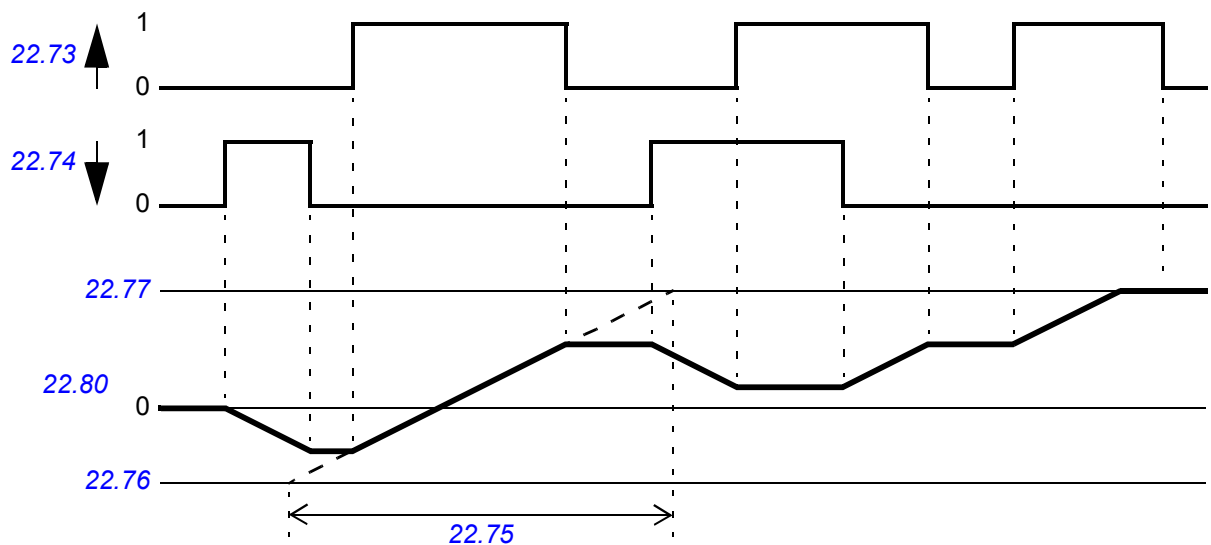

Settings

Parameters [22.71...22.80](#) (page 205).

DC voltage control

■ Overvoltage control

Overvoltage control of the intermediate DC link is typically needed when the motor is in generating mode. The motor can generate when it decelerates or when the load overhauls the motor shaft, causing the shaft to turn faster than the applied speed or frequency. To prevent the DC voltage from exceeding the overvoltage control limit, the overvoltage controller automatically decreases the generating torque when the limit is reached. The overvoltage controller also increases any programmed deceleration times if the limit is reached; to achieve shorter deceleration times, a brake chopper and resistor may be required.

■ Undervoltage control (power loss ride-through)

If the incoming supply voltage is cut off, the drive will continue to operate by utilizing the kinetic energy of the rotating motor. The drive will be fully operational as long as the motor rotates and generates energy to the drive. The drive can continue operation after the break if the main contactor (if present) remained closed.

Note: Units equipped with a main contactor must be equipped with a hold circuit (e.g. UPS) to keep the contactor control circuit closed during a short supply break.

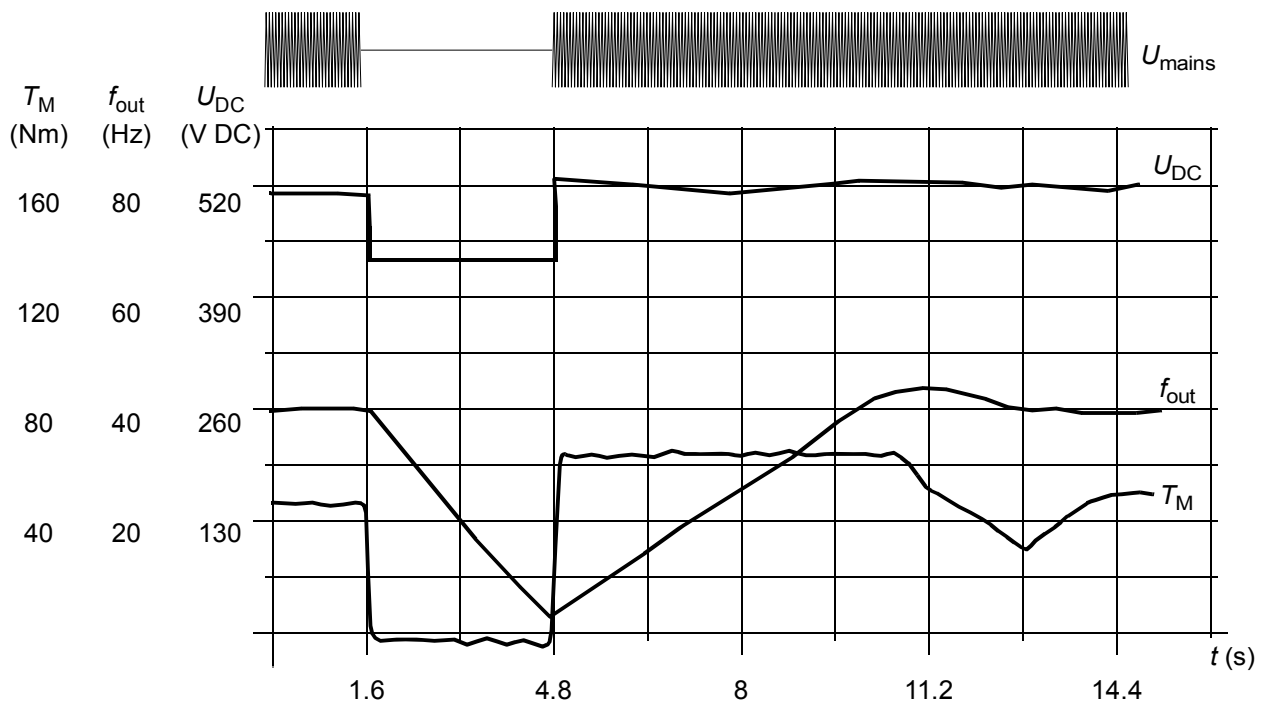

U_{DC} = intermediate circuit voltage of the drive, f_{out} = output frequency of the drive, T_M = motor torque
 Loss of supply voltage at nominal load ($f_{out} = 40$ Hz). The intermediate circuit DC voltage drops to the minimum limit. The controller keeps the voltage steady as long as the mains is switched off. The drive runs the motor in generator mode. The motor speed falls but the drive is operational as long as the motor has enough kinetic energy.

Automatic restart

It is possible to restart the drive automatically after a short (max. 5 seconds) power supply failure by using the Automatic restart function provided that the drive is allowed to run for 5 seconds without the cooling fans operating.

When enabled, the function takes the following actions upon a supply failure to enable a successful restart:

- The undervoltage fault is suppressed (but a warning is generated)
- Modulation and cooling is stopped to conserve any remaining energy
- DC circuit pre-charging is enabled.

If the DC voltage is restored before the expiration of the period defined by parameter [21.18 Auto restart time](#) and the start signal is still on, normal operation will continue. However, if the DC voltage remains too low at that point, the drive trips on a fault, [3280 Standby timeout](#).



WARNING! Before you activate the function, make sure that no dangerous situations can occur. The function restarts the drive automatically and continues operation after a supply break.

■ Voltage control and trip limits

The control and trip limits of the intermediate DC voltage regulator are relative to the supply voltage as well as drive/inverter type. The DC voltage is approximately 1.35 times the line-to-line supply voltage, and is displayed by parameter [01.11 DC voltage](#).

The following table shows the values of selected DC voltage levels in volts. All voltages are relative to the supply voltage range selected in parameter [95.01 Supply voltage](#).

Level	Supply voltage range [V] (see 95.01 Supply voltage)					
	208...240	380...415	440...480	500	525...600	660...690
Overvoltage fault limit	489/440*	800	878	780	1113	1218
Overvoltage control limit	389	700	778	810	1013	1118
Internal brake chopper at 100% pulse width	403	697	806	806	1008	1159
Internal brake chopper at 0% pulse width	375	648	749	780	936	1077
Overvoltage warning limit	373	644	745	776	932	1071
DC voltage at upper bound of supply voltage range (U_{DCmax})	324	560	648	675	810	932
DC voltage at lower bound of supply voltage range	281	513	594	675	709	891
Undervoltage control and warning limit	239	436	505	574	602	757
Charging activation/standby limit	225	410	475	540	567	713
Undervoltage fault limit	168	308	356	405	425	535

*489 V with frames R1...R3, 440 V with frames R4...R8.

Settings

Parameters [01.11 DC voltage](#) (page 95), [30.30 Overvoltage control](#) (page 262), [30.31 Undervoltage control](#) (page 262) and [95.01 Supply voltage](#) (page 406).

■ Brake chopper

A brake chopper can be used to handle the energy generated by a decelerating motor. When the DC voltage rises high enough, the chopper connects the DC circuit to an external brake resistor. The chopper operates on the pulse width modulation principle.

The internal brake choppers of ACS880-M04 drives start conducting when the DC link voltage reaches $1.156 \times U_{DCmax}$. 100% pulse width is reached at approximately $1.2 \times U_{DCmax}$, depending on supply voltage range – see table under [Voltage control and trip limits](#) above. (U_{DCmax} is the DC voltage corresponding to the maximum of the AC supply voltage range.) For information on external brake choppers, refer to their documentation.

Note: For runtime braking, overvoltage control (parameter [30.30 Overvoltage control](#)) needs to be disabled for the chopper to operate.

Settings

Parameters [01.11 DC voltage](#) (page 95) and [30.30 Overvoltage control](#) (page 262).

Safety and protections

■ Emergency stop

The emergency stop signal is connected to the input selected by parameter [21.05 Emergency stop source](#). An emergency stop can also be generated through fieldbus (parameter [06.01 Main control word](#), bits 0...2).

The mode of the emergency stop is selected by parameter [21.04 Emergency stop mode](#). The following modes are available:

- Off1: Stop along the standard deceleration ramp defined for the particular reference type in use
- Off2: Stop by coasting
- Off3: Stop by the emergency stop ramp defined by parameter [23.23 Emergency stop time](#).

With Off1 or Off3 emergency stop modes, the ramp-down of the motor speed can be supervised by parameters [31.32 Emergency ramp supervision](#) and [31.33 Emergency ramp supervision delay](#).

Notes:

- For SIL 3 / PL e-level emergency stop functions, the drive can be fitted with a TÜV-certified FSO-xx safety options module. The module can then be incorporated into certified safety systems.
- The installer of the equipment is responsible for installing the emergency stop devices and all additional devices needed for the emergency stop function to fulfill the required emergency stop categories. For more information, contact your local ABB representative.
- After an emergency stop signal is detected, the emergency stop function cannot be canceled even though the signal is canceled.
- If the minimum (or maximum) torque limit is set to 0%, the emergency stop function may not be able to stop the drive.
- Speed and torque reference additives (parameters [22.15](#), [22.17](#), [26.16](#), [26.25](#) and [26.41](#)) and reference ramp shapes ([23.16](#)...[23.19](#)) are ignored in case of emergency ramp stops.

Settings

Parameters [06.17 Drive status word 2](#) (page 110), [06.18 Start inhibit status word](#) (page 111), [21.04 Emergency stop mode](#) (page 191), [21.05 Emergency stop source](#) (page 191), [23.23 Emergency stop time](#) (page 213), [25.13 Min torq sp ctrl em stop](#) (page 227), [25.14 Max torq sp ctrl em stop](#) (page 227), [25.15 Proportional gain em stop](#) (page 227), [31.32 Emergency ramp supervision](#) (page 272) and [31.33 Emergency ramp supervision delay](#) (page 272).

■ Motor thermal protection

The control program features two separate motor temperature monitoring functions. The temperature data sources and warning/trip limits can be set up independently for each function.

The motor temperature can be monitored using

- the motor thermal protection model (estimated temperature derived internally inside the drive), or
- sensors installed in the windings. This will result in a more accurate motor model.

In addition to temperature monitoring, a protection function is available for 'Ex' motors installed in a potentially explosive atmosphere.

Motor thermal protection model

The drive calculates the temperature of the motor on the basis of the following assumptions:

1. When power is applied to the drive for the first time, the motor is assumed to be at ambient temperature (defined by parameter [35.50 Motor ambient temperature](#)). After this, when power is applied to the drive, the motor is assumed to be at the estimated temperature.
2. Motor temperature is calculated using the user-adjustable motor thermal time and motor load curve. The load curve should be adjusted in case the ambient temperature exceeds 30 °C.

Note: The motor thermal model can be used when only one motor is connected to the inverter.

Temperature monitoring using PTC sensors

One PTC sensor can be connected to digital input DI6.

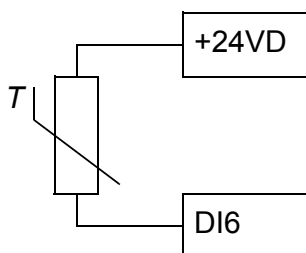

The resistance of the PTC sensor increases when its temperature rises. The increasing resistance of the sensor decreases the voltage at the input, and eventually its state switches from 1 to 0, indicating overtemperature.

1...3 PTC sensors can also be connected in series to an analog input and an analog output. The analog output feeds a constant excitation current of 1.6 mA through the sensor. The sensor resistance increases as the motor temperature rises, as does the

voltage over the sensor. The temperature measurement function calculates the resistance of the sensor and generates an indication if overtemperature is detected.

For wiring of the sensor, refer to the *Hardware Manual* of the drive.

The figure below shows typical PTC sensor resistance values as a function of temperature.

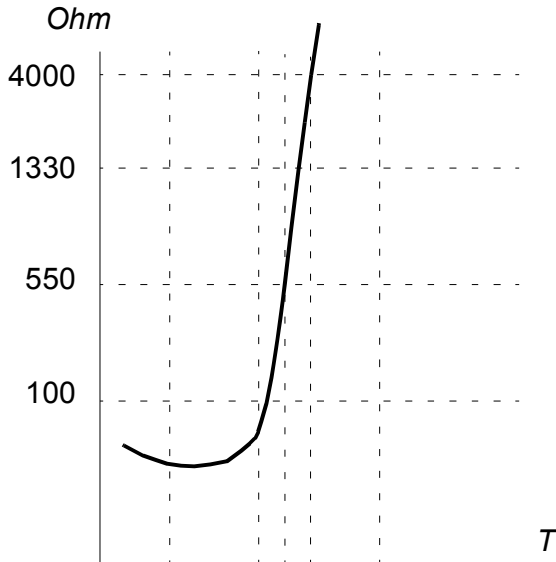

In addition to the above, optional FEN-xx encoder interfaces have connections for PTC sensors. Refer to the module-specific documentation for more information.

Temperature monitoring using Pt100 or Pt1000 sensors

1...3 Pt100 or Pt1000 sensors can be connected in series to an analog input and an analog output.

The analog output feeds a constant excitation current of 9.1 mA (Pt100) or 1 mA (Pt1000) through the sensor. The sensor resistance increases as the motor temperature rises, as does the voltage over the sensor. The temperature measurement function reads the voltage through the analog input and converts it into degrees Celsius.

The warning and fault limits can be adjusted by parameters.

For the wiring of the sensor, refer to the *Hardware Manual* of the drive.

Temperature monitoring using KTY84 sensors

One KTY84 sensor can be connected to an analog input and an analog output on the control unit.

The analog output feeds a constant excitation current of 2.0 mA through the sensor. The sensor resistance increases as the motor temperature rises, as does the voltage over the sensor. The temperature measurement function reads the voltage through the analog input and converts it into degrees Celsius.

FEN-xx encoder interfaces (optional) also have a connection for one KTY84 sensor.

The figure and table below show typical KTY84 sensor resistance values as a function of the motor operating temperature.

KTY84 scaling
90 °C = 936 ohm
110 °C = 1063 ohm
130 °C = 1197 ohm
150 °C = 1340 ohm

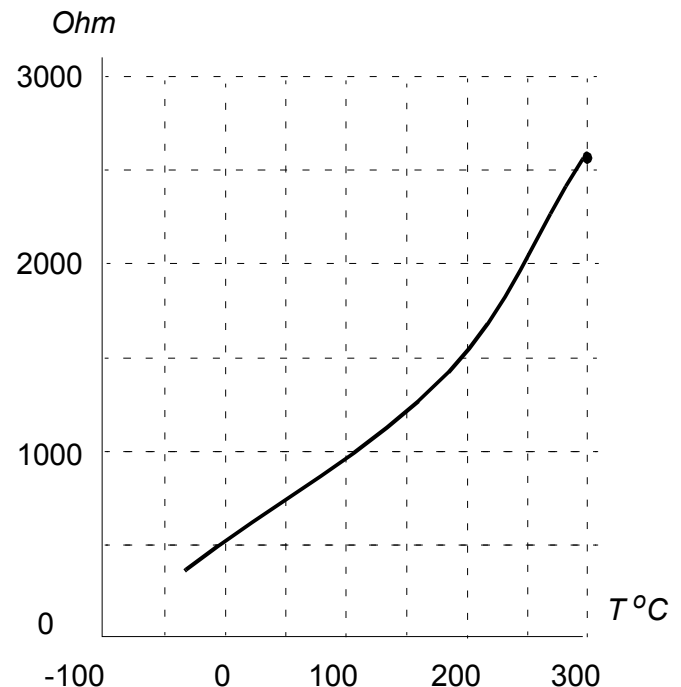

The warning and fault limits can be adjusted by parameters.

For the wiring of the sensor, refer to the *Hardware Manual* of the drive.

Motor fan control logic (parameters [35.100](#)...[35.106](#))

If the motor has an external cooling fan, it is possible to use a drive signal (for example, running/stopped) to control the starter of the fan via a relay or digital output. A digital input can be selected for fan feedback. A loss of the feedback signal will optionally cause a warning or a fault.

Start and stop delays can be defined for the fan. In addition, a feedback delay can be set to define the time within which feedback must be received after the fan starts.

Ex motor support (parameter [95.15](#), bit 0)

The control program has a temperature protection function for Ex motors located in a potentially explosive atmosphere. The protection is enabled by setting bit 0 of parameter [95.15 Special HW settings](#).

Settings

Parameter groups [35 Motor thermal protection](#) (page [290](#)) and [91 Encoder module settings](#) (page [391](#)); parameter [95.15 Special HW settings](#) (page [408](#)).

■ Thermal protection of motor cable

The control program contains a thermal protection function for the motor cable. This function should be used, for example, when the nominal current of the drive exceeds the current-carrying capacity of the motor cable.

The program calculates the temperature of the cable on the basis of the following data:

- Measured output current (parameter [01.07 Motor current](#))
- Nominal continuous current rating of the cable, specified by [35.61 Cable nominal current](#), and
- Thermal time constant of the cable, specified by [35.62 Cable thermal rise time](#).

When the calculated temperature of the cable reaches 102% of the rated maximum, a warning ([A480 Motor cable overload](#)) is given. The drive trips on a fault ([4000 Motor cable overload](#)) when 106% is reached.

Settings

Parameters [35.60...35.62](#) (page [300](#)).

■ Other programmable protection functions

External events (parameters [31.01...31.10](#))

Five different event signals from the process can be connected to selectable inputs to generate trips and warnings for the driven equipment. When the signal is lost, an external event (fault, warning, or a mere log entry) is generated. The contents of the messages can be edited on the control panel by selecting **Menu - Settings - Edit texts**.

Motor phase loss detection (parameter [31.19](#))

The parameter selects how the drive reacts whenever a motor phase loss is detected.

Earth (Ground) fault detection (parameter [31.20](#))

The earth fault detection function is based on sum current measurement. Note that

- an earth fault in the supply cable does not activate the protection
- in a grounded supply, the protection activates within 2 milliseconds
- in an ungrounded supply, the supply capacitance must be 1 microfarad or more
- the capacitive currents caused by shielded motor cables up to 300 meters will not activate the protection
- the protection is deactivated when the drive is stopped.

Supply phase loss detection (parameter [31.21](#))

The parameter selects how the drive reacts whenever a supply phase loss is detected.

Safe torque off detection (parameter [31.22](#))

The drive monitors the status of the Safe torque off input, and this parameter selects which indications are given when the signals are lost. (The parameter does not affect the operation of the Safe torque off function itself). For more information on the Safe torque off function, see the *Hardware manual*.

Swapped supply and motor cabling (parameter [31.23](#))

The drive can detect if the supply and motor cables have accidentally been swapped (for example, if the supply is connected to the motor connection of the drive). The parameter selects if a fault is generated or not. Note that the protection should be disabled in drive/inverter hardware supplied from a common DC bus.

Stall protection (parameters [31.24](#)...[31.28](#))

The drive protects the motor in a stall situation. It is possible to adjust the supervision limits (current, frequency and time) and choose how the drive reacts to a motor stall condition.

Overspeed protection (parameter [31.30](#))

The user can set overspeed limits by specifying a margin that is added to the currently-used maximum and minimum speed limits.

Ramp stop supervision (parameters [31.32](#), [31.33](#), [31.37](#) and [31.38](#))

The control program has a supervision function for both the normal and emergency stop ramps. The user can either define a maximum time for stopping, or a maximum deviation from the expected deceleration rate. If the drive fails to stop in the expected manner, a fault is generated and the drive coasts to a stop.

Custom motor current fault limit (parameter [31.42](#))

The control program sets a motor current limit based on drive hardware. In most cases, the default value is appropriate. However, a lower limit can be manually set by the user, for example, to protect a permanent magnet motor from demagnetization.

Local control loss detection (parameter [49.05](#))

The parameter selects how the drive reacts to a control panel or PC tool communication break.

■ Automatic fault resets

The drive can automatically reset itself after overcurrent, overvoltage, undervoltage and external faults. The user can also specify a fault that is automatically reset.

By default, automatic resets are off and must be specifically activated by the user.



WARNING! Before you activate the function, make sure that no dangerous situations can occur. The function resets the drive automatically and continues operation after a fault.

Settings

Parameters [31.12](#)...[31.16](#) (page [266](#)).

Diagnostics

■ Fault and warning messages, data logging

See chapter [Fault tracing](#) (page 479).

■ Signal supervision

Three signals can be selected to be supervised by this function. Whenever a supervised signal exceeds or falls below predefined limits, a bit in [32.01 Supervision status](#) is activated, and a warning or fault generated. The contents of the message can be edited on the control panel by selecting **Menu - Settings - Edit texts**.

The supervised signal is low-pass filtered.

Settings

Parameter group [32 Supervision](#) (page 276).

■ Maintenance timers and counters

The program has six different maintenance timers or counters that can be configured to generate a warning when a pre-defined limit is reached. The contents of the message can be edited on the control panel by selecting **Menu - Settings - Edit texts**.

The timer/counter can be set to monitor any parameter. This feature is especially useful as a service reminder.

There are three types of counters:

- On-time timers. Measures the time a binary source (for example, a bit in a status word) is on.
- Signal edge counters. The counter is incremented whenever the monitored binary source changes state.
- Value counters. The counter measures, by integration, the monitored parameter. A warning is given when the calculated area below the signal peak exceeds a user-defined limit.

Settings

Parameter group [33 Generic timer & counter](#) (page 280).

■ Energy saving calculators

This feature consists of the following functionalities:

- An energy optimizer that adjusts the motor flux in such a way that the total system efficiency is maximized
- A counter that monitors used and saved energy by the motor and displays them in kWh, currency or volume of CO₂ emissions, and
- A load analyzer showing the load profile of the drive (see separate section on page [80](#)).

Note: The accuracy of the energy savings calculation is directly dependent on the accuracy of the reference motor power given in parameter [45.19 Comparison power](#).

Settings

Parameter group [45 Energy efficiency](#) (page [316](#)).

■ Load analyzer

Peak value logger

The user can select a signal to be monitored by a peak value logger. The logger records the peak value of the signal along with the time the peak occurred, as well as motor current, DC voltage and motor speed at the time of the peak. The peak value is sampled at 2 ms intervals.

Amplitude loggers

The control program has two amplitude loggers.

For amplitude logger 2, the user can select a signal to be sampled at 200 ms intervals, and specify a value that corresponds to 100%. The collected samples are sorted into 10 read-only parameters according to their amplitude. Each parameter represents an amplitude range 10 percentage points wide, and displays the percentage of the collected samples that have fallen within that range.

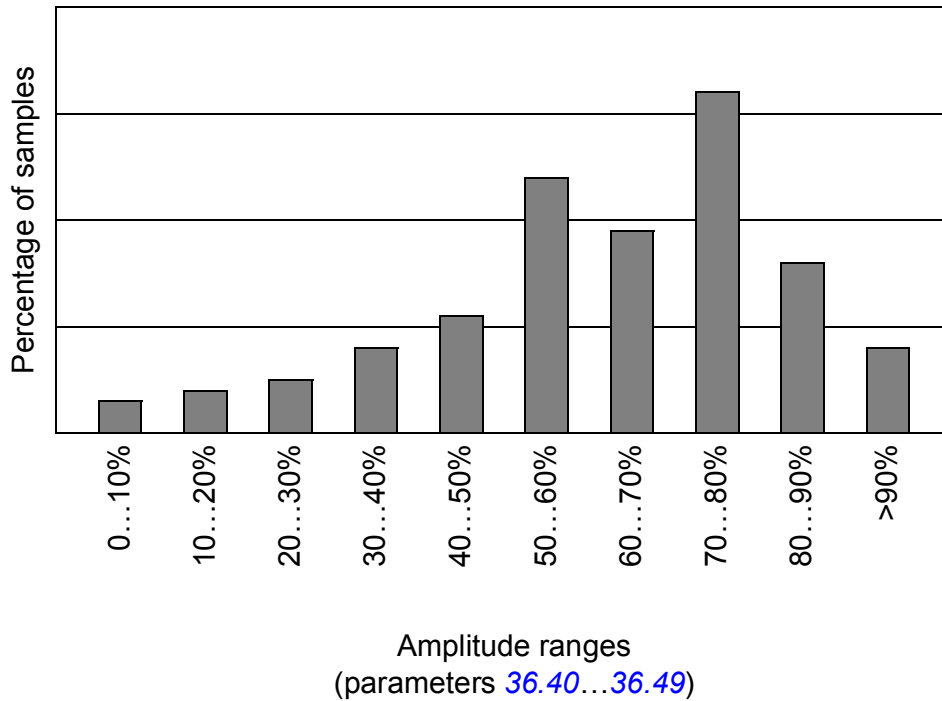

Amplitude logger 1 is fixed to monitor motor current, and cannot be reset. With amplitude logger 1, 100% corresponds to the maximum output current of the drive (I_{\max} , as given in the hardware manual). The measured current is logged continuously. The distribution of samples is shown by parameters [36.20](#)...[36.29](#).

Settings

Parameter group [36 Load analyzer](#) (page [304](#)).

Miscellaneous

■ User parameter sets

The drive supports four user parameter sets that can be saved to the permanent memory and recalled using drive parameters. It is also possible to use digital inputs to switch between user parameter sets.

A user parameter set contains all editable values in parameter groups 10...99 except

- forced I/O values such as parameters [10.03 DI force selection](#) and [10.04 DI force data](#)
- I/O extension module settings (groups 14...15)
- data storage parameters (group 47)
- fieldbus communication settings (groups 51...56 and 58)
- encoder configuration settings (groups 92...93), and
- parameter [95.01 Supply voltage](#).

As the motor settings are included in the user parameter sets, make sure the settings correspond to the motor used in the application before recalling a user set. In an application where different motors are used with the drive, the motor ID run needs to be performed with each motor and the results saved to different user sets. The appropriate set can then be recalled when the motor is switched.

Settings

Parameters [96.10...96.13](#) (page [413](#)).

■ Data storage parameters

Twenty-four (sixteen 32-bit, eight 16-bit) parameters are reserved for data storage. These parameters are unconnected by default and can be used for eg. linking, testing and commissioning purposes. They can be written to and read from using other parameters' source or target selections.

Note that “*Analog src*” type parameters (see page [435](#)) expect a 32-bit real (floating point) source – in other words, parameters [47.01...47.08](#) can be used as a value source of other parameters while [47.11...47.28](#) cannot.

To use a 16-bit integer (received in DDCS data sets) as the source of another parameter, write the value into one of the “real32” type storage parameters ([47.01...47.08](#)). Select the storage parameter as the source, and define a suitable scaling method between the 16-bit and 32-bit values in parameters [47.31...47.38](#).

Settings

Parameter group [47 Data storage](#) (page [324](#)).

■ du/dt filter support

With an external du/dt filter connected to the output of the drive, bit 13 of [95.20 HW options word 1](#) must be switched on. The setting enables an overtemperature protection for the filter. Note that the setting is not to be activated with inverter modules with internal du/dt filters.

Settings

Parameter [95.20 HW options word 1](#) (page [409](#)).



Application macros

What this chapter contains

This chapter describes the intended use, operation and default control connections of the application macros.

More information on the connectivity of the control unit is given in the *Hardware manual* of the drive.

General

Application macros are sets of default parameter values suitable for the application in question. When starting up the drive, the user typically selects the best-suited application macro as a starting point, then makes any necessary changes to tailor the settings to the application. This usually results in a much lower number of user edits compared to the traditional way of programming a drive.

Application macros can be selected by parameter [96.04 Macro select](#). User parameter sets are managed by the parameters in group [96 System](#).

Factory macro

The Factory macro is suited to relatively straightforward speed control applications such as conveyors, pumps and fans, and test benches.

The drive is speed-controlled with the reference signal connected to analog input AI1. The start/stop commands are given through digital input DI1; running direction is determined by DI2. This macro uses control location EXT1.

Faults are reset through digital input DI3.



DI4 switches between acceleration/deceleration time sets 1 and 2. The acceleration and deceleration times, as well as ramp shapes, are defined by parameters [23.12...23.19](#).

DI5 activates constant speed 1.

■ **Default parameter settings for the Factory macro**

The default parameter settings for the Factory macro are listed under [Parameter listing](#) (page [94](#)).

■ Default control connections for the Factory macro

XPOW External power input			
1	+24VI	24 V DC, 2 A	
2	GND		
XAI Reference voltage and analog inputs			
1	+VREF	10 V DC, R_L 1...10 kohm	
2	-VREF	-10 V DC, R_L 1...10 kohm	
3	AGND	Ground	
4	AI1+	Speed reference	
5	AI1-	0(2)...10 V, $R_{in} > 200$ kohm	
6	AI2+	By default not in use.	
7	AI2-	0(4)...20 mA, $R_{in} > 100$ ohm	
XAO Analog outputs			
1	AO1	Motor speed rpm	
2	AGND	0...20 mA, $R_L < 500$ ohm	
3	AO2	Motor current	
4	AGND	0...20 mA, $R_L < 500$ ohm	
XD2D Drive-to-drive link			
1	B	Drive-to-drive link	
2	A		
3	BGND		
XRO1, XRO2, XRO3 Relay outputs			
1	NC	 Ready run	
2	COM		250 V AC / 30 V DC
3	NO		2 A
1	NC	 Running	
2	COM		250 V AC / 30 V DC
3	NO		2 A
1	NC	 Fault (-1)	
2	COM		250 V AC / 30 V DC
3	NO		2 A
XD24 Digital interlock			
1	DIIL	Run enable	
2	+24VD	+24 V DC 200 mA	
3	DICOM	Digital input ground	
4	+24VD	+24 V DC 200 mA	
5	DIOGND	Digital input/output ground	
XDIO Digital input/outputs			
1	DIO1	Output: Ready run	
2	DIO2	Output: Running	
XDI Digital inputs			
1	DI1	Stop (0) / Start (1)	
2	DI2	Forward (0) / Reverse (1)	
3	DI3	Reset	
4	DI4	Acc/Dec time set 1 (0) / set 2 (1)	
5	DI5	Constant speed 1 (1 = On)	
6	DI6	By default, not in use.	
XSTO	Safe torque off circuits must be closed for the drive to start. See <i>Hardware manual</i> of drive.		
X12	Safety options connection		
X13	Control panel connection		
X205	Memory unit connection		



Parameters

What this chapter contains

The chapter describes the parameters, including actual signals, of the control program.

Terms and abbreviations

Term	Definition
Actual signal	Type of <i>parameter</i> that is the result of a measurement or calculation by the drive, or contains status information. Most actual signals are read-only, but some (especially counter-type actual signals) can be reset.
Def	(In the following table, shown on the same row as the parameter name) The default value of a <i>parameter</i> when used in the Factory macro. For information on other macro-specific parameter values, see chapter <i>Application macros</i> (page 85). Note: Certain configurations or optional equipment may require specific default values. These are labelled as follows: (95.20 bx) = Default changed or write-protected by parameter 95.20, bit x.
FbEq16	(In the following table, shown on the same row as the parameter range, or for each selection) 16-bit fieldbus equivalent: The scaling between the value shown on the panel and the integer used in communication when a 16-bit value is selected for transmission to an external system. A dash (-) indicates that the parameter is not accessible in 16-bit format. The corresponding 32-bit scalings are listed in chapter <i>Additional parameter data</i> (page 435).
Other	The value is taken from another parameter. Choosing “Other” displays a parameter list in which the user can specify the source parameter. Note: The source parameter must be a 32-bit real (floating point) number. To use a 16-bit integer (for example, received from an external device in data sets) as the source, data storage parameters 47.01...47.08 (page 324) can be used.
Other [bit]	The value is taken from a specific bit in another parameter. Choosing “Other” displays a parameter list in which the user can specify the source parameter and bit.
Parameter	Either a user-adjustable operating instruction for the drive, or an <i>actual signal</i> .
p.u.	Per unit

Summary of parameter groups

Group	Contents	Page
01 Actual values	Basic signals for monitoring the drive.	94
03 Input references	Values of references received from various sources.	98
04 Warnings and faults	Information on warnings and faults that occurred last.	99
05 Diagnostics	Various run-time-type counters and measurements related to drive maintenance.	106
06 Control and status words	Drive control and status words.	108
07 System info	Drive hardware and firmware information.	120
10 Standard DI, RO	Configuration of digital inputs and relay outputs.	122
11 Standard DIO, FI, FO	Configuration of digital input/outputs and frequency inputs/outputs.	130
12 Standard AI	Configuration of standard analog inputs.	136
13 Standard AO	Configuration of standard analog outputs.	141
14 I/O extension module 1	Configuration of I/O extension module 1.	147
15 I/O extension module 2	Configuration of I/O extension module 2.	169
19 Operation mode	Selection of local and external control location sources and operating modes.	173
20 Start/stop/direction	Start/stop/direction and run/start/jog enable signal source selection; positive/negative reference enable signal source selection.	176
21 Start/stop mode	Start and stop modes; emergency stop mode and signal source selection; DC magnetization settings; autophasing mode selection.	188
22 Speed reference selection	Speed reference selection; motor potentiometer settings.	198
23 Speed reference ramp	Speed reference ramp settings (programming of the acceleration and deceleration rates for the drive).	209
24 Speed reference conditioning	Speed error calculation; speed error window control configuration; speed error step.	217
25 Speed control	Speed controller settings.	220
26 Torque reference chain	Settings for the torque reference chain.	234
28 Frequency reference chain	Settings for the frequency reference chain.	243
30 Limits	Drive operation limits.	255
31 Fault functions	Configuration of external events; selection of behavior of the drive upon fault situations.	263
32 Supervision	Configuration of signal supervision functions 1...3.	276
33 Generic timer & counter	Configuration of maintenance timers/counters.	280

Group	Contents	Page
35 Motor thermal protection	Motor thermal protection settings such as temperature measurement configuration, load curve definition and motor fan control configuration.	290
36 Load analyzer	Peak value and amplitude logger settings.	304
43 Brake chopper	Settings for the internal brake chopper.	308
44 Mechanical brake control	Configuration of mechanical brake control.	310
45 Energy efficiency	Settings for the energy saving calculators.	316
46 Monitoring/scaling settings	Speed supervision settings; actual signal filtering; general scaling settings.	320
47 Data storage	Data storage parameters that can be written to and read from using other parameters' source and target settings.	324
49 Panel port communication	Communication settings for the control panel port on the drive.	327
50 Fieldbus adapter (FBA)	Fieldbus communication configuration.	330
51 FBA A settings	Fieldbus adapter A configuration.	341
52 FBA A data in	Selection of data to be transferred from drive to fieldbus controller through fieldbus adapter A.	342
53 FBA A data out	Selection of data to be transferred from fieldbus controller to drive through fieldbus adapter A.	343
54 FBA B settings	Fieldbus adapter B configuration.	344
55 FBA B data in	Selection of data to be transferred from drive to fieldbus controller through fieldbus adapter B.	345
56 FBA B data out	Selection of data to be transferred from fieldbus controller to drive through fieldbus adapter B.	346
58 Embedded fieldbus	Configuration of the embedded fieldbus (EFB) interface.	346
60 DDCS communication	DDCS communication configuration.	357
61 D2D and DDCS transmit data	Defines the data sent to the DDCS link.	366
62 D2D and DDCS receive data	Mapping of data received through the DDCS link.	370
90 Feedback selection	Motor and load feedback configuration.	379
91 Encoder module settings	Configuration of encoder interface modules.	391
92 Encoder 1 configuration	Settings for encoder 1.	395
93 Encoder 2 configuration	Settings for encoder 2.	403
95 HW configuration	Various hardware-related settings.	406
96 System	Language selection; access levels; macro selection; parameter save and restore; control unit reboot; user parameter sets; unit selection.	410

Group	Contents	Page
<i>97 Motor control</i>	Motor model settings.	<i>419</i>
<i>98 User motor parameters</i>	Motor values supplied by the user that are used in the motor model.	<i>423</i>
<i>99 Motor data</i>	Motor configuration settings.	<i>425</i>
<i>200 Safety</i>	FSO-xx settings.	<i>433</i>

Parameter listing

No.	Name/Value	Description	Def/FbEq16
01 Actual values		Basic signals for monitoring the drive. All parameters in this group are read-only unless otherwise noted.	
01.01	Motor speed used	Measured or estimated motor speed depending on which type of feedback is used (see parameter 90.41 Motor feedback selection). A filter time constant for this signal can be defined by parameter 46.11 Filter time motor speed .	-
	-30000.00 ... 30000.00 rpm	Measured or estimated motor speed.	See par. 46.01
01.02	Motor speed estimated	Estimated motor speed in rpm. A filter time constant for this signal can be defined by parameter 46.11 Filter time motor speed .	-
	-30000.00 ... 30000.00 rpm	Estimated motor speed.	See par. 46.01
01.03	Motor speed %	Shows the value of 01.01 Motor speed used in percent of the synchronous speed of the motor.	10 = 1%
	-1000.00 ... 1000.00%	Measured or estimated motor speed.	See par. 46.01
01.04	Encoder 1 speed filtered	Speed of encoder 1 in rpm. A filter time constant for this signal can be defined by parameter 46.11 Filter time motor speed .	-
	-30000.00 ... 30000.00 rpm	Encoder 1 speed.	See par. 46.01
01.05	Encoder 2 speed filtered	Speed of encoder 2 in rpm. A filter time constant for this signal can be defined by parameter 46.11 Filter time motor speed .	-
	-30000.00 ... 30000.00 rpm	Encoder 2 speed.	See par. 46.01
01.06	Output frequency	Estimated drive output frequency in Hz. A filter time constant for this signal can be defined by parameter 46.12 Filter time output frequency .	-
	-500.00 ... 500.00 Hz	Estimated output frequency.	See par. 46.02
01.07	Motor current	Measured (absolute) motor current in A.	-
	0.00 ... 30000.00 A	Motor current.	See par. 46.05

No.	Name/Value	Description	Def/FbEq16
01.10	Motor torque	Motor torque in percent of the nominal motor torque. See also parameter 01.30 Nominal torque scale . A filter time constant for this signal can be defined by parameter 46.13 Filter time motor torque .	-
	-1600.0 ... 1600.0%	Motor torque.	See par. 46.03
01.11	DC voltage	Measured DC link voltage.	-
	0.00 ... 2000.00 V	DC link voltage.	10 = 1 V
01.13	Output voltage	Calculated motor voltage in V AC.	-
	0...2000 V	Motor voltage.	1 = 1 V
01.14	Output power	Drive output power. The unit is selected by parameter 96.16 Unit selection . A filter time constant for this signal can be defined by parameter 46.14 Filter time power out .	-
	-32768.00 ... 32767.00 kW or hp	Output power.	1 = 1 unit
01.15	Output power % of motor nom	Shows the value of 01.14 Output power in percent of the nominal power of the motor.	-
	-300.00 ... 300.00%	Output power.	1 = 1%
01.17	Motor shaft power	Estimated mechanical power at motor shaft. The unit is selected by parameter 96.16 Unit selection . A filter time constant for this signal can be defined by parameter 46.14 Filter time power out .	-
	-32768.00 ... 32767.00 kW or hp	Motor shaft power.	1 = 1 unit
01.18	Inverter GWh motoring	Amount of energy that has passed through the drive (towards the motor) in full gigawatt-hours. The minimum value is zero.	-
	0...32767 GWh	Motoring energy in GWh.	1 = 1 GWh
01.19	Inverter MWh motoring	Amount of energy that has passed through the drive (towards the motor) in full megawatt-hours. Whenever the counter rolls over, 01.18 Inverter GWh motoring is incremented. The minimum value is zero.	-
	0...999 MWh	Motoring energy in MWh.	1 = 1 MWh

No.	Name/Value	Description	Def/FbEq16
01.20	<i>Inverter kWh motoring</i>	Amount of energy that has passed through the drive (towards the motor) in full kilowatt-hours. Whenever the counter rolls over, 01.19 Inverter MWh motoring is incremented. The minimum value is zero.	-
	0...999 kWh	Motoring energy in kWh.	10 = 1 kWh
01.21	<i>U-phase current</i>	Measured U-phase current.	-
	-30000.00 ... 30000.00 A	U-phase current.	See par. 46.05
01.22	<i>V-phase current</i>	Measured V-phase current.	-
	-30000.00 ... 30000.00 A	V-phase current.	See par. 46.05
01.23	<i>W-phase current</i>	Measured W-phase current.	-
	-30000.00 ... 30000.00 A	W-phase current.	See par. 46.05
01.24	<i>Flux actual %</i>	Used flux reference in percent of nominal flux of motor.	-
	0...200%	Flux reference.	1 = 1%
01.29	<i>Speed change rate</i>	Rate of actual speed change. Positive values indicate acceleration, negative values indicate deceleration. See also parameters 31.32 Emergency ramp supervision , 31.33 Emergency ramp supervision delay , 31.37 Ramp stop supervision and 31.38 Ramp stop supervision delay .	-
	-15000 ... 15000 rpm/s	Rate of speed change.	1 = 1 rpm/s
01.30	<i>Nominal torque scale</i>	Torque that corresponds to 100% of nominal motor torque. The unit is selected by parameter 96.16 Unit selection Note: This value is copied from parameter 99.12 Motor nominal torque if entered. Otherwise the value is calculated from other motor data.	-
	0.000... N·m or lb·ft	Nominal torque.	1 = 100 unit
01.31	<i>Ambient temperature</i>	Measured temperature of incoming cooling air. The unit is selected by parameter 96.16 Unit selection .	-
	-40 ... 120 °C or °F	Cooling air temperature.	1 = 1°
01.32	<i>Inverter GWh regenerating</i>	Amount of energy that has passed through the drive (towards the supply) in full gigawatt-hours. The minimum value is zero.	-
	0...32767 GWh	Motoring energy in GWh.	1 = 1 GWh

No.	Name/Value	Description	Def/FbEq16
01.33	Inverter MWh regenerating	Amount of energy that has passed through the drive (towards the supply) in full megawatt-hours. Whenever the counter rolls over, 01.32 Inverter GWh regenerating is incremented. The minimum value is zero.	-
	0...999 MWh	Motoring energy in MWh.	1 = 1 MWh
01.34	Inverter kWh regenerating	Amount of energy that has passed through the drive (towards the supply) in full kilowatt-hours. Whenever the counter rolls over, 01.33 Inverter MWh regenerating is incremented. The minimum value is zero.	-
	0...999 kWh	Motoring energy in kWh.	10 = 1 kWh
01.35	Mot - regen energy GWh	Amount of net energy (motoring energy - regenerating energy) that has passed through the drive in full gigawatt-hours.	-
	-32768... 32767 GWh	Motoring energy in GWh.	1 = 1 GWh
01.36	Mot - regen energy MWh	Amount of net energy (motoring energy - regenerating energy) that has passed through the drive in full megawatt-hours. Whenever the counter rolls over, 01.35 Mot - regen energy GWh is incremented or decremented.	-
	-999...999 MWh	Motoring energy in MWh.	1 = 1 MWh
01.37	Mot - regen energy kWh	Amount of energy (motoring energy - regenerating energy) that has passed through the drive in full kilowatt-hours. Whenever the counter rolls over, 01.36 Mot - regen energy MWh is incremented or decremented.	-
	-999...999 kWh	Motoring energy in kWh.	10 = 1 kWh
01.61	Abs motor speed used	Absolute value of 01.01 Motor speed used .	-
	0.00 ... 30000.00 rpm	Measured or estimated motor speed.	See par. 46.01
01.62	Abs motor speed %	Absolute value of 01.03 Motor speed % .	-
	0.00 ... 1000.00%	Measured or estimated motor speed.	See par. 46.01
01.63	Abs output frequency	Absolute value of 01.06 Output frequency .	-
	0.00 ... 500.00 Hz	Estimated output frequency.	See par. 46.02
01.64	Abs motor torque	Absolute value of 01.10 Motor torque .	-
	0.0 ... 1600.0%	Motor torque.	See par. 46.03

No.	Name/Value	Description	Def/FbEq16
01.65	<i>Abs output power</i>	Absolute value of <i>01.14 Output power</i> .	-
	0.00 ... 32767.00 kW or hp	Output power.	1 = 1 unit
01.66	<i>Abs output power % motor nom</i>	Absolute value of <i>01.15 Output power % of motor nom</i> .	-
	0.00 ... 300.00%	Output power.	1 = 1%
01.68	<i>Abs motor shaft power</i>	Absolute value of <i>01.17 Motor shaft power</i> .	-
	0.00 ... 32767.00 kW or hp	Motor shaft power.	1 = 1 unit
03 Input references		Values of references received from various sources. All parameters in this group are read-only unless otherwise noted.	
03.01	<i>Panel reference</i>	Local reference given from the control panel or PC tool.	-
	-100000.00 ... 100000.00	Local control panel or PC tool reference.	1 = 10
03.02	<i>Panel reference 2</i>	Remote reference given from the control panel or PC tool.	-
	-30000.00 ... 30000.00	Remote control panel or PC tool reference.	1 = 10
03.05	<i>FB A reference 1</i>	Reference 1 received through fieldbus adapter A. See also chapter <i>Fieldbus control through a fieldbus adapter</i> (page 551).	-
	-100000.00 ... 100000.00	Reference 1 from fieldbus adapter A.	1 = 10
03.06	<i>FB A reference 2</i>	Reference 2 received through fieldbus adapter A.	-
	-100000.00 ... 100000.00	Reference 2 from fieldbus adapter A.	1 = 10
03.07	<i>FB B reference 1</i>	Reference 1 received through fieldbus adapter B.	-
	-100000.00 ... 100000.00	Reference 1 from fieldbus adapter B.	1 = 10
03.08	<i>FB B reference 2</i>	Reference 2 received through fieldbus adapter B.	-
	-100000.00 ... 100000.00	Reference 2 from fieldbus adapter B.	1 = 10
03.09	<i>EFB reference 1</i>	Scaled reference 1 received through the embedded fieldbus interface. The scaling is defined by <i>58.26 EFB ref1 type</i> .	1 = 10
	-30000.00 ... 30000.00	Reference 1 received through the embedded fieldbus interface.	1 = 10

No.	Name/Value	Description	Def/FbEq16
03.10	<i>EFB reference 2</i>	Scaled reference 2 received through the embedded fieldbus interface. The scaling is defined by 58.27 EFB ref2 type .	1 = 10
	-30000.00 ... 30000.00	Reference 2 received through the embedded fieldbus interface.	1 = 10
03.13	<i>M/F or D2D ref1</i>	Master/follower reference 1 received from the master. The value has been scaled according to parameter 60.10 M/F ref1 type . See also section Master/follower functionality (page 39).	1 = 10
	-30000.00 ... 30000.00	Scaled reference 1 received from master.	1 = 10
03.14	<i>M/F or D2D ref2</i>	Master/follower reference 2 received from the master. The value has been scaled according to parameter 60.11 M/F ref2 type .	1 = 10
	-30000.00 ... 30000.00	Scaled reference 2 received from master.	1 = 10
04 Warnings and faults		Information on warnings and faults that occurred last. For explanations of individual warning and fault codes, see chapter Fault tracing . All parameters in this group are read-only unless otherwise noted.	
04.01	<i>Tripping fault</i>	Code of the 1st active fault (the fault that caused the current trip).	-
	0000h...FFFFh	1st active fault.	1 = 1
04.02	<i>Active fault 2</i>	Code of the 2nd active fault.	-
	0000h...FFFFh	2nd active fault.	1 = 1
04.03	<i>Active fault 3</i>	Code of the 3rd active fault.	-
	0000h...FFFFh	3rd active fault.	1 = 1
04.04	<i>Active fault 4</i>	Code of the 4th active fault.	-
	0000h...FFFFh	4th active fault.	1 = 1
04.05	<i>Active fault 5</i>	Code of the 5th active fault.	-
	0000h...FFFFh	5th active fault.	1 = 1
04.06	<i>Active warning 1</i>	Code of the 1st active warning.	-
	0000h...FFFFh	1st active warning.	1 = 1
04.07	<i>Active warning 2</i>	Code of the 2nd active warning.	-
	0000h...FFFFh	2nd active warning.	1 = 1
04.08	<i>Active warning 3</i>	Code of the 3rd active warning.	-
	0000h...FFFFh	3rd active warning.	1 = 1
04.09	<i>Active warning 4</i>	Code of the 4th active warning.	-
	0000h...FFFFh	4th active warning.	1 = 1

100 Parameters

No.	Name/Value	Description	Def/FbEq16
<i>04.10</i>	<i>Active warning 5</i>	Code of the 5th active warning.	-
	0000h...FFFFh	5th active warning.	1 = 1
<i>04.11</i>	<i>Latest fault</i>	Code of the 1st stored (non-active) fault.	-
	0000h...FFFFh	1st stored fault.	1 = 1
<i>04.12</i>	<i>2nd latest fault</i>	Code of the 2nd stored (non-active) fault.	-
	0000h...FFFFh	2nd stored fault.	1 = 1
<i>04.13</i>	<i>3rd latest fault</i>	Code of the 3rd stored (non-active) fault.	-
	0000h...FFFFh	3rd stored fault.	1 = 1
<i>04.14</i>	<i>4th latest fault</i>	Code of the 4th stored (non-active) fault.	-
	0000h...FFFFh	4th stored fault.	1 = 1
<i>04.15</i>	<i>5th latest fault</i>	Code of the 5th stored (non-active) fault.	-
	0000h...FFFFh	5th stored fault.	1 = 1
<i>04.16</i>	<i>Latest warning</i>	Code of the 1st stored (non-active) warning.	-
	0000h...FFFFh	1st stored warning.	1 = 1
<i>04.17</i>	<i>2nd latest warning</i>	Code of the 2nd stored (non-active) warning.	-
	0000h...FFFFh	2nd stored warning.	1 = 1
<i>04.18</i>	<i>3rd latest warning</i>	Code of the 3rd stored (non-active) warning.	-
	0000h...FFFFh	3rd stored warning.	1 = 1
<i>04.19</i>	<i>4th latest warning</i>	Code of the 4th stored (non-active) warning.	-
	0000h...FFFFh	4th stored warning.	1 = 1
<i>04.20</i>	<i>5th latest warning</i>	Code of the 5th stored (non-active) warning.	-
	0000h...FFFFh	5th stored warning.	1 = 1

No.	Name/Value	Description	Def/FbEq16																																																																						
04.21	<i>Fault word 1</i>	<p>ACS800-compatible fault word 1.</p> <p>The bit assignments of this word correspond to FAULT WORD 1 in the ACS800. Parameter 04.120 Fault/Warning word compatibility determines whether the bit assignments are according to the ACS800 Standard or ACS800 System control program.</p> <p>Each bit can indicate several ACS880-M04 events as listed below.</p> <p>This parameter is read-only.</p>	-																																																																						
<table border="1"> <thead> <tr> <th rowspan="2">Bit</th> <th colspan="2">ACS800 fault name</th> <th rowspan="2">ACS880-M04 events indicated by this bit (see Fault tracing, page 479)</th> </tr> <tr> <th>(04.120 = ACS800 Standard ctrl program)</th> <th>(04.120 = ACS800 System ctrl program)</th> </tr> </thead> <tbody> <tr> <td>0</td> <td>SHORT CIRC</td> <td>SHORT CIRC</td> <td>2340</td> </tr> <tr> <td>1</td> <td>OVERCURRENT</td> <td>OVERCURRENT</td> <td>2310</td> </tr> <tr> <td>2</td> <td>DC OVERVOLT</td> <td>DC OVERVOLT</td> <td>3210</td> </tr> <tr> <td>3</td> <td>ACS800 TEMP</td> <td>ACS800 TEMP</td> <td>2381, 4210, 4290, 42F1, 4310, 4380</td> </tr> <tr> <td>4</td> <td>EARTH FAULT</td> <td>EARTH FAULT</td> <td>2330, 2392, 3181</td> </tr> <tr> <td>5</td> <td>THERMISTOR</td> <td>MOTOR TEMP M</td> <td>4981</td> </tr> <tr> <td>6</td> <td>MOTOR TEMP</td> <td>MOTOR TEMP</td> <td>4982</td> </tr> <tr> <td>7</td> <td>SYSTEM_FAULT</td> <td>SYSTEM_FAULT</td> <td>6481, 6487, 64A1, 64A2, 64A3, 64B1, 64E1, 6881, 6882, 6883, 6885</td> </tr> <tr> <td>8</td> <td>UNDERLOAD</td> <td>UNDERLOAD</td> <td>-</td> </tr> <tr> <td>9</td> <td>OVERFREQ</td> <td>OVERFREQ</td> <td>7310</td> </tr> <tr> <td>10</td> <td>Reserved</td> <td>MPROT SWITCH</td> <td>9081</td> </tr> <tr> <td>11</td> <td>Reserved</td> <td>CH2 COMM LOSS</td> <td>7582</td> </tr> <tr> <td>12</td> <td>Reserved</td> <td>SC (INU1)</td> <td>2340 (XXYY YY01)</td> </tr> <tr> <td>13</td> <td>Reserved</td> <td>SC (INU2)</td> <td>2340 (XXYY YY02)</td> </tr> <tr> <td>14</td> <td>Reserved</td> <td>SC (INU3)</td> <td>2340 (XXYY YY03)</td> </tr> <tr> <td>15</td> <td>Reserved</td> <td>SC (INU4)</td> <td>2340 (XXYY YY04)</td> </tr> </tbody> </table>				Bit	ACS800 fault name		ACS880-M04 events indicated by this bit (see Fault tracing , page 479)	(04.120 = ACS800 Standard ctrl program)	(04.120 = ACS800 System ctrl program)	0	SHORT CIRC	SHORT CIRC	2340	1	OVERCURRENT	OVERCURRENT	2310	2	DC OVERVOLT	DC OVERVOLT	3210	3	ACS800 TEMP	ACS800 TEMP	2381 , 4210 , 4290 , 42F1 , 4310 , 4380	4	EARTH FAULT	EARTH FAULT	2330 , 2392 , 3181	5	THERMISTOR	MOTOR TEMP M	4981	6	MOTOR TEMP	MOTOR TEMP	4982	7	SYSTEM_FAULT	SYSTEM_FAULT	6481 , 6487 , 64A1 , 64A2 , 64A3 , 64B1 , 64E1 , 6881 , 6882 , 6883 , 6885	8	UNDERLOAD	UNDERLOAD	-	9	OVERFREQ	OVERFREQ	7310	10	Reserved	MPROT SWITCH	9081	11	Reserved	CH2 COMM LOSS	7582	12	Reserved	SC (INU1)	2340 (XXYY YY01)	13	Reserved	SC (INU2)	2340 (XXYY YY02)	14	Reserved	SC (INU3)	2340 (XXYY YY03)	15	Reserved	SC (INU4)	2340 (XXYY YY04)
Bit	ACS800 fault name		ACS880-M04 events indicated by this bit (see Fault tracing , page 479)																																																																						
	(04.120 = ACS800 Standard ctrl program)	(04.120 = ACS800 System ctrl program)																																																																							
0	SHORT CIRC	SHORT CIRC	2340																																																																						
1	OVERCURRENT	OVERCURRENT	2310																																																																						
2	DC OVERVOLT	DC OVERVOLT	3210																																																																						
3	ACS800 TEMP	ACS800 TEMP	2381 , 4210 , 4290 , 42F1 , 4310 , 4380																																																																						
4	EARTH FAULT	EARTH FAULT	2330 , 2392 , 3181																																																																						
5	THERMISTOR	MOTOR TEMP M	4981																																																																						
6	MOTOR TEMP	MOTOR TEMP	4982																																																																						
7	SYSTEM_FAULT	SYSTEM_FAULT	6481 , 6487 , 64A1 , 64A2 , 64A3 , 64B1 , 64E1 , 6881 , 6882 , 6883 , 6885																																																																						
8	UNDERLOAD	UNDERLOAD	-																																																																						
9	OVERFREQ	OVERFREQ	7310																																																																						
10	Reserved	MPROT SWITCH	9081																																																																						
11	Reserved	CH2 COMM LOSS	7582																																																																						
12	Reserved	SC (INU1)	2340 (XXYY YY01)																																																																						
13	Reserved	SC (INU2)	2340 (XXYY YY02)																																																																						
14	Reserved	SC (INU3)	2340 (XXYY YY03)																																																																						
15	Reserved	SC (INU4)	2340 (XXYY YY04)																																																																						
0000h...FFFFh		ACS800-compatible fault word 1.	1 = 1																																																																						

No.	Name/Value	Description	Def/FbEq16
04.22	<i>Fault word 2</i>	<p>ACS800-compatible fault word 2.</p> <p>The bit assignments of this word correspond to FAULT WORD 2 in the ACS800. Parameter <i>04.120 Fault/Warning word compatibility</i> determines whether the bit assignments are according to the ACS800 Standard or ACS800 System control program.</p> <p>Each may indicate several ACS880-M04 events as listed below.</p> <p>This parameter is read-only.</p>	-

Bit	ACS800 fault name		ACS880-M04 events indicated by this bit (see <i>Fault tracing</i> , page 479)
	(<i>04.120</i> = ACS800 Standard ctrl program)	(<i>04.120</i> = ACS800 System ctrl program)	
0	SUPPLY PHASE	SUPPLY PHASE	3130
1	NO MOT DATA	NO MOTOR DATA	-
2	DC UNDERVOLT	DC UNDERVOLT	3220
3	Reserved	CABLE TEMP	4000
4	RUN ENABLE	RUN DISABLE	AFEB
5	ENCODER ERR	ENCODER ERR	7301, 7380, 7381, 73A0, 73A1
6	I/O COMM	IO COMM ERR	7080, 7082
7	CTRL B TEMP	CTRL B TEMP	-
8	EXTERNAL FLT	SELECTABLE	9082
9	OVER SWFREQ	OVER SWFREQ	-
10	AI < MIN FUNC	AI<MIN FUNC	80A0
11	PPCC LINK	PPCC LINK	5681, 5682, 5690, 5691, 5692, 5693, 5694
12	COMM MODULE	COMM MODULE	6681, 7510, 7520
13	PANEL LOSS	PANEL LOSS	7081
14	MOTOR STALL	MOTOR STALL	7121
15	MOTOR PHASE	MOTOR PHASE	3381

0000h...FFFFh	ACS800-compatible fault word 2.	1 = 1
---------------	---------------------------------	-------

No.	Name/Value	Description	Defl/FbEq16																																																																						
04.31	Warning word 1	<p>ACS800-compatible warning (alarm) word 1.</p> <p>The bit assignments of this word correspond to ALARM WORD 1 in the ACS800. Parameter 04.120 Fault/Warning word compatibility determines whether the assignments are according to the ACS800 Standard or ACS800 System control program.</p> <p>Each may indicate several ACS880-M04 warnings as listed below.</p> <p>This parameter is read-only.</p>	-																																																																						
<table border="1"> <thead> <tr> <th rowspan="2">Bit</th> <th colspan="2">ACS800 alarm name</th> <th rowspan="2">ACS880-M04 events indicated by this bit (see Fault tracing, page 479)</th> </tr> <tr> <th>(04.120 = ACS800 Standard ctrl program)</th> <th>(04.120 = ACS800 System ctrl program)</th> </tr> </thead> <tbody> <tr> <td>0</td> <td>START INHIBIT</td> <td>START INHIBI</td> <td>B5A0</td> </tr> <tr> <td>1</td> <td>Reserved</td> <td>EM STOP</td> <td>AFE1, AFE2</td> </tr> <tr> <td>2</td> <td>THERMISTOR</td> <td>MOTOR TEMP M</td> <td>A491</td> </tr> <tr> <td>3</td> <td>MOTOR TEMP</td> <td>MOTOR TEMP</td> <td>A492</td> </tr> <tr> <td>4</td> <td>ACS800 TEMP</td> <td>ACS800 TEMP</td> <td>A2BA, A4A1, A4A9, A4B0, A4B1, A4F6</td> </tr> <tr> <td>5</td> <td>ENCODER ERR</td> <td>ENCODER ERR</td> <td>A797, A7B0, A7B1, A7E1</td> </tr> <tr> <td>6</td> <td>T MEAS ALM</td> <td>T MEAS CIRC</td> <td>A490, A5EA, A782, A8A0</td> </tr> <tr> <td>7</td> <td>Reserved</td> <td>DIGITAL IO</td> <td>-</td> </tr> <tr> <td>8</td> <td>Reserved</td> <td>ANALOG IO</td> <td>-</td> </tr> <tr> <td>9</td> <td>Reserved</td> <td>EXT DIGITAL IO</td> <td>-</td> </tr> <tr> <td>10</td> <td>Reserved</td> <td>EXT ANALOG IO</td> <td>A6E5, A7AA, A7AB</td> </tr> <tr> <td>11</td> <td>Reserved</td> <td>CH2 COMM LOSS</td> <td>A7CB</td> </tr> <tr> <td>12</td> <td>COMM MODULE</td> <td>MPROT SWITCH</td> <td>A981</td> </tr> <tr> <td>13</td> <td>Reserved</td> <td>EM STOP DEC</td> <td>-</td> </tr> <tr> <td>14</td> <td>EARTH FAULT</td> <td>EARTH FAULT</td> <td>A2B3</td> </tr> <tr> <td>15</td> <td>Reserved</td> <td>SAFETY SWITC</td> <td>A983</td> </tr> </tbody> </table>				Bit	ACS800 alarm name		ACS880-M04 events indicated by this bit (see Fault tracing , page 479)	(04.120 = ACS800 Standard ctrl program)	(04.120 = ACS800 System ctrl program)	0	START INHIBIT	START INHIBI	B5A0	1	Reserved	EM STOP	AFE1 , AFE2	2	THERMISTOR	MOTOR TEMP M	A491	3	MOTOR TEMP	MOTOR TEMP	A492	4	ACS800 TEMP	ACS800 TEMP	A2BA , A4A1 , A4A9 , A4B0 , A4B1 , A4F6	5	ENCODER ERR	ENCODER ERR	A797 , A7B0 , A7B1 , A7E1	6	T MEAS ALM	T MEAS CIRC	A490 , A5EA , A782 , A8A0	7	Reserved	DIGITAL IO	-	8	Reserved	ANALOG IO	-	9	Reserved	EXT DIGITAL IO	-	10	Reserved	EXT ANALOG IO	A6E5 , A7AA , A7AB	11	Reserved	CH2 COMM LOSS	A7CB	12	COMM MODULE	MPROT SWITCH	A981	13	Reserved	EM STOP DEC	-	14	EARTH FAULT	EARTH FAULT	A2B3	15	Reserved	SAFETY SWITC	A983
Bit	ACS800 alarm name		ACS880-M04 events indicated by this bit (see Fault tracing , page 479)																																																																						
	(04.120 = ACS800 Standard ctrl program)	(04.120 = ACS800 System ctrl program)																																																																							
0	START INHIBIT	START INHIBI	B5A0																																																																						
1	Reserved	EM STOP	AFE1 , AFE2																																																																						
2	THERMISTOR	MOTOR TEMP M	A491																																																																						
3	MOTOR TEMP	MOTOR TEMP	A492																																																																						
4	ACS800 TEMP	ACS800 TEMP	A2BA , A4A1 , A4A9 , A4B0 , A4B1 , A4F6																																																																						
5	ENCODER ERR	ENCODER ERR	A797 , A7B0 , A7B1 , A7E1																																																																						
6	T MEAS ALM	T MEAS CIRC	A490 , A5EA , A782 , A8A0																																																																						
7	Reserved	DIGITAL IO	-																																																																						
8	Reserved	ANALOG IO	-																																																																						
9	Reserved	EXT DIGITAL IO	-																																																																						
10	Reserved	EXT ANALOG IO	A6E5 , A7AA , A7AB																																																																						
11	Reserved	CH2 COMM LOSS	A7CB																																																																						
12	COMM MODULE	MPROT SWITCH	A981																																																																						
13	Reserved	EM STOP DEC	-																																																																						
14	EARTH FAULT	EARTH FAULT	A2B3																																																																						
15	Reserved	SAFETY SWITC	A983																																																																						
0000h...FFFFh		ACS800-compatible warning (alarm) word 1.	1 = 1																																																																						

No.	Name/Value	Description	Def/FbEq16																																																																						
04.32	<i>Warning word 2</i>	<p>ACS800-compatible warning (alarm) word 2.</p> <p>The bit assignments of this word correspond to ALARM WORD 2 in the ACS800. Parameter 04.120 Fault/Warning word compatibility determines whether the bit assignments are according to the ACS800 Standard or ACS800 System control program.</p> <p>Each may indicate several ACS880-M04 warnings as listed below.</p> <p>This parameter is read-only.</p>	-																																																																						
<table border="1"> <thead> <tr> <th rowspan="2">Bit</th> <th colspan="2">ACS800 alarm name</th> <th rowspan="2">ACS880-M04 events indicated by this bit (see Fault tracing, page 479)</th> </tr> <tr> <th>(04.120 = ACS800 Standard ctrl program)</th> <th>(04.120 = ACS800 System ctrl program)</th> </tr> </thead> <tbody> <tr> <td>0</td> <td>Reserved</td> <td>MOTOR FAN</td> <td>A781</td> </tr> <tr> <td>1</td> <td>UNDERLOAD</td> <td>UNDERLOAD</td> <td>-</td> </tr> <tr> <td>2</td> <td>Reserved</td> <td>INV OVERLOAD</td> <td>-</td> </tr> <tr> <td>3</td> <td>Reserved</td> <td>CABLE TEMP</td> <td>A480</td> </tr> <tr> <td>4</td> <td>ENCODER</td> <td>ENCODER A<>B</td> <td>-</td> </tr> <tr> <td>5</td> <td>Reserved</td> <td>FAN OVERTEMP</td> <td>A984</td> </tr> <tr> <td>6</td> <td>Reserved</td> <td>Reserved</td> <td>-</td> </tr> <tr> <td>7</td> <td>POWFAIL FILE</td> <td>POWFAIL FILE</td> <td>-</td> </tr> <tr> <td>8</td> <td>ALM (OS_17)</td> <td>POWDOWN FILE</td> <td>-</td> </tr> <tr> <td>9</td> <td>MOTOR STALL</td> <td>MOTOR STALL</td> <td>A780</td> </tr> <tr> <td>10</td> <td>AI < MIN FUNC</td> <td>AI<MIN FUNC</td> <td>A8A0</td> </tr> <tr> <td>11</td> <td>Reserved</td> <td>COMM MODULE</td> <td>A6D1, A6D2, A7C1, A7C2, A7CE</td> </tr> <tr> <td>12</td> <td>Reserved</td> <td>BATT FAILURE</td> <td>-</td> </tr> <tr> <td>13</td> <td>PANEL LOSS</td> <td>PANEL LOSS</td> <td>A7EE</td> </tr> <tr> <td>14</td> <td>Reserved</td> <td>DC UNDERVOLT</td> <td>A3A2</td> </tr> <tr> <td>15</td> <td>Reserved</td> <td>RESTARTED</td> <td>-</td> </tr> </tbody> </table>				Bit	ACS800 alarm name		ACS880-M04 events indicated by this bit (see Fault tracing , page 479)	(04.120 = ACS800 Standard ctrl program)	(04.120 = ACS800 System ctrl program)	0	Reserved	MOTOR FAN	A781	1	UNDERLOAD	UNDERLOAD	-	2	Reserved	INV OVERLOAD	-	3	Reserved	CABLE TEMP	A480	4	ENCODER	ENCODER A<>B	-	5	Reserved	FAN OVERTEMP	A984	6	Reserved	Reserved	-	7	POWFAIL FILE	POWFAIL FILE	-	8	ALM (OS_17)	POWDOWN FILE	-	9	MOTOR STALL	MOTOR STALL	A780	10	AI < MIN FUNC	AI<MIN FUNC	A8A0	11	Reserved	COMM MODULE	A6D1 , A6D2 , A7C1 , A7C2 , A7CE	12	Reserved	BATT FAILURE	-	13	PANEL LOSS	PANEL LOSS	A7EE	14	Reserved	DC UNDERVOLT	A3A2	15	Reserved	RESTARTED	-
Bit	ACS800 alarm name		ACS880-M04 events indicated by this bit (see Fault tracing , page 479)																																																																						
	(04.120 = ACS800 Standard ctrl program)	(04.120 = ACS800 System ctrl program)																																																																							
0	Reserved	MOTOR FAN	A781																																																																						
1	UNDERLOAD	UNDERLOAD	-																																																																						
2	Reserved	INV OVERLOAD	-																																																																						
3	Reserved	CABLE TEMP	A480																																																																						
4	ENCODER	ENCODER A<>B	-																																																																						
5	Reserved	FAN OVERTEMP	A984																																																																						
6	Reserved	Reserved	-																																																																						
7	POWFAIL FILE	POWFAIL FILE	-																																																																						
8	ALM (OS_17)	POWDOWN FILE	-																																																																						
9	MOTOR STALL	MOTOR STALL	A780																																																																						
10	AI < MIN FUNC	AI<MIN FUNC	A8A0																																																																						
11	Reserved	COMM MODULE	A6D1 , A6D2 , A7C1 , A7C2 , A7CE																																																																						
12	Reserved	BATT FAILURE	-																																																																						
13	PANEL LOSS	PANEL LOSS	A7EE																																																																						
14	Reserved	DC UNDERVOLT	A3A2																																																																						
15	Reserved	RESTARTED	-																																																																						
0000h...FFFFh		ACS800-compatible warning (alarm) word 2.	1 = 1																																																																						

No.	Name/Value	Description	Def/FbEq16															
04.40	Event word 1	User-defined event word. This word collects the status of the events (warnings, faults or pure events) selected by parameters 04.41 ... 04.72 . For each event, an auxiliary code can optionally be specified for filtering. This parameter is read-only.	-															
		<table border="1"> <thead> <tr> <th>Bit</th> <th>Name</th> <th>Description</th> </tr> </thead> <tbody> <tr> <td>0</td> <td>User bit 0</td> <td>1 = Event selected by parameters 04.41 (and 04.42) is active</td> </tr> <tr> <td>1</td> <td>User bit 1</td> <td>1 = Event selected by parameters 04.43 (and 04.44) is active</td> </tr> <tr> <td>...</td> <td>...</td> <td>...</td> </tr> <tr> <td>15</td> <td>User bit 15</td> <td>1 = Event selected by parameters 04.71 (and 04.72) is active</td> </tr> </tbody> </table>	Bit	Name	Description	0	User bit 0	1 = Event selected by parameters 04.41 (and 04.42) is active	1	User bit 1	1 = Event selected by parameters 04.43 (and 04.44) is active	15	User bit 15	1 = Event selected by parameters 04.71 (and 04.72) is active	
Bit	Name	Description																
0	User bit 0	1 = Event selected by parameters 04.41 (and 04.42) is active																
1	User bit 1	1 = Event selected by parameters 04.43 (and 04.44) is active																
...																
15	User bit 15	1 = Event selected by parameters 04.71 (and 04.72) is active																
	0000h...FFFFh	User-defined event word.	1 = 1															
04.41	Event word 1 bit 0 code	Selects the hexadecimal code of an event (warning, fault or pure event) whose status is shown as bit 0 of 04.40 Event word 1 . The event codes are listed in chapter Fault tracing (page 479).	0000h															
	0000h...FFFFh	Code of event.	1 = 1															
04.42	Event word 1 bit 0 aux code	Specifies an auxiliary code for the event selected by the previous parameter. The selected event is indicated by the event word only if its auxiliary code matches the value of this parameter. With a value of 0000 0000h, the event word will indicate the event regardless of the auxiliary code.	0000 0000h															
	0000 0000h ... FFFF FFFFh	Code of warning, fault or pure event.	1 = 1															
04.43	Event word 1 bit 1 code	Selects the hexadecimal code of an event (warning, fault or pure event) whose status is shown as bit 1 of 04.40 Event word 1 . The event codes are listed in chapter Fault tracing (page 479).	0000h															
	0000h...FFFFh	Code of event.	1 = 1															
04.44	Event word 1 bit 1 aux code	Specifies an auxiliary code for the event selected by the previous parameter. The selected event is indicated by the event word only if its auxiliary code matches the value of this parameter. With a value of 0000 0000h, the event word will indicate the event regardless of the auxiliary code.	0000 0000h															
	0000 0000h ... FFFF FFFFh	Code of warning, fault or pure event.	1 = 1															
...															

No.	Name/Value	Description	Def/FbEq16
04.71	Event word 1 bit 15 code	Selects the hexadecimal code of an event (warning, fault or pure event) whose status is shown as bit 15 of 04.40 Event word 1 . The event codes are listed in chapter Fault tracing (page 479).	0000h
	0000h...FFFFh	Code of event.	1 = 1
04.72	Event word 1 bit 15 aux code	Specifies an auxiliary code for the event selected by the previous parameter. The selected event is indicated by the event word only if its auxiliary code matches the value of this parameter. With a value of 0000 0000h, the event word will indicate the event regardless of the auxiliary code.	0000 0000h
	0000 0000h ... FFFF FFFFh	Code of warning, fault or pure event.	1 = 1
04.120	Fault/Warning word compatibility	Selects whether the bit assignments of parameters 04.21...04.32 correspond to the ACS800 Standard control program or the ACS800 System control program.	<i>False</i>
	ACS800 Standard ctrl program	The bit assignments of parameters 04.21...04.32 correspond to the ACS800 Standard control program as follows: 04.21 Fault word 1 : 03.05 FAULT WORD 1 04.22 Fault word 2 : 03.06 FAULT WORD 2 04.31 Warning word 1 : 03.08 ALARM WORD 1 04.32 Warning word 2 : 03.09 ALARM WORD 2	0
	ACS800 System ctrl program	The bit assignments of parameters 04.21...04.32 correspond to the ACS800 System control program as follows: 04.21 Fault word 1 : 09.01 FAULT WORD 1 04.22 Fault word 2 : 09.02 FAULT WORD 2 04.31 Warning word 1 : 09.04 ALARM WORD 1 04.32 Warning word 2 : 09.05 ALARM WORD 2	1
05 Diagnostics		Various run-time-type counters and measurements related to drive maintenance. All parameters in this group are read-only unless otherwise noted.	
05.01	On-time counter	On-time counter. The counter runs when the drive is powered.	-
	0...65535 d	On-time counter.	1 = 1 d
05.02	Run-time counter	Motor run-time counter. The counter runs when the inverter modulates.	-
	0...65535 d	Motor run-time counter.	1 = 1 d

No.	Name/Value	Description	Def/FbEq16															
05.04	<i>Fan on-time counter</i>	Running time of the drive cooling fan. Can be reset from the control panel by keeping Reset depressed for over 3 seconds.	-															
	0...65535 d	Cooling fan run-time counter.	1 = 1 d															
05.11	<i>Inverter temperature</i>	Estimated drive temperature in percent of fault limit. The fault limit varies according to the type of the drive. 0.0% = 0 °C (32 °F) 100.0% = Fault limit	-															
	-40.0 ... 160.0%	Drive temperature in percent.	1 = 1%															
05.22	<i>Diagnostic word 3</i>	Diagnostic word 3.	-															
<table border="1"> <thead> <tr> <th>Bit</th> <th>Name</th> <th>Value</th> </tr> </thead> <tbody> <tr> <td>0...10</td> <td colspan="2">Reserved</td> </tr> <tr> <td>11</td> <td>Fan command</td> <td>1 = Drive fan is rotating above idle speed</td> </tr> <tr> <td>12</td> <td>Fan service counter</td> <td>1 = Drive fan service counter has reached its limit</td> </tr> <tr> <td>13...15</td> <td colspan="2">Reserved</td> </tr> </tbody> </table>				Bit	Name	Value	0...10	Reserved		11	Fan command	1 = Drive fan is rotating above idle speed	12	Fan service counter	1 = Drive fan service counter has reached its limit	13...15	Reserved	
Bit	Name	Value																
0...10	Reserved																	
11	Fan command	1 = Drive fan is rotating above idle speed																
12	Fan service counter	1 = Drive fan service counter has reached its limit																
13...15	Reserved																	
	0000h...FFFFh	Diagnostic word 3.	1 = 1															
05.41	<i>Main fan service counter</i>	Displays the age of the main cooling fan as a percentage of its estimated lifetime. The estimate is based on the duty, operating conditions and other operating parameters of the fan. When the counter reaches 100%, a warning (<i>A8C0 Fan service counter</i>) is generated. Can be reset from the control panel by keeping Reset depressed for over 3 seconds.	-															
	0...150%	Main cooling fan age.	1 = 1%															
05.42	<i>Aux. fan service counter</i>	Displays the age of the auxiliary cooling fan as a percentage of its estimated lifetime. The estimate is based on the duty, operating conditions and other operating parameters of the fan. When the counter reaches 100%, a warning (<i>A8C0 Fan service counter</i>) is generated. Can be reset from the control panel by keeping Reset depressed for over 3 seconds.	-															
	0...150%	Auxiliary cooling fan age.	1 = 1%															

No.	Name/Value	Description	Def/FbEq16
06 Control and status words			
06.01	<i>Main control word</i>	<p>The main control word of the drive. This parameter shows the control signals as received from the selected sources (such as digital inputs, the fieldbus interfaces and the application program). The bit assignments of the word are as described on page 558. The related status word and state diagram are presented on pages 559 and 560 respectively.</p> <p>Note: Bits 12...15 can be used to carry additional control data, and used as a signal source by any binary-source selector parameter.</p> <p>This parameter is read-only.</p>	-
	0000h...FFFFh	Main control word.	1 = 1
06.02	<i>Application control word</i>	<p>The drive control word received from the application program (if any). The bit assignments are described on page 558.</p> <p>This parameter is read-only.</p>	-
	0000h...FFFFh	Application program control word.	1 = 1
06.03	<i>FBA A transparent control word</i>	<p>The unaltered control word received from the PLC through fieldbus adapter A.</p> <p>This parameter is read-only.</p>	-
	00000000h ... FFFFFFFFh	Control word received through fieldbus adapter A.	-
06.04	<i>FBA B transparent control word</i>	<p>The unaltered control word received from the PLC through fieldbus adapter B.</p> <p>This parameter is read-only.</p>	-
	00000000h ... FFFFFFFFh	Control word received through fieldbus adapter B.	1 = 1
06.05	<i>EFB transparent control word</i>	<p>The unaltered control word received from the PLC through the embedded fieldbus interface.</p> <p>This parameter is read-only.</p>	-
	00000000h ... FFFFFFFFh	Control word received through the embedded fieldbus interface.	1 = 1
06.11	<i>Main status word</i>	<p>Main status word of the drive.</p> <p>The bit assignments are described on page 559. The related control word and state diagram are presented on pages 558 and 560 respectively.</p> <p>This parameter is read-only.</p>	-
	0000h...FFFFh	Main status word.	1 = 1

No.	Name/Value	Description	Def/FbEq16																																																
06.16	Drive status word 1	Drive status word 1. This parameter is read-only.	-																																																
		<table border="1"> <thead> <tr> <th>Bit</th> <th>Name</th> <th>Description</th> </tr> </thead> <tbody> <tr> <td>0</td> <td>Enabled</td> <td>1 = Both run enable (see par. 20.12) and start enable (20.19) signals are present. Note: This bit is not affected by the presence of a fault.</td> </tr> <tr> <td>1</td> <td>Inhibited</td> <td>1 = Start inhibited. See parameters 06.18 and 06.25 for the source of the inhibiting signal.</td> </tr> <tr> <td>2</td> <td>DC charged</td> <td>1 = DC circuit has been charged</td> </tr> <tr> <td>3</td> <td>Ready to start</td> <td>1 = Drive is ready to receive a start command</td> </tr> <tr> <td>4</td> <td>Following reference</td> <td>1 = Drive is ready to follow given reference</td> </tr> <tr> <td>5</td> <td>Started</td> <td>1 = Drive has been started</td> </tr> <tr> <td>6</td> <td>Modulating</td> <td>1 = Drive is modulating (output stage is being controlled)</td> </tr> <tr> <td>7</td> <td>Limiting</td> <td>1 = Any operating limit (speed, torque, etc.) is active</td> </tr> <tr> <td>8</td> <td>Local control</td> <td>1 = Drive is in local control</td> </tr> <tr> <td>9</td> <td>Network ctrl</td> <td>1 = Drive is in <i>network control</i> (see page 14)</td> </tr> <tr> <td>10</td> <td>Ext1 active</td> <td>1 = Control location EXT1 active</td> </tr> <tr> <td>11</td> <td>Ext2 active</td> <td>1 = Control location EXT2 active</td> </tr> <tr> <td>12</td> <td>Reserved</td> <td></td> </tr> <tr> <td>13</td> <td>Start request</td> <td>1 = Start requested</td> </tr> <tr> <td>14...15</td> <td>Reserved</td> <td></td> </tr> </tbody> </table>	Bit	Name	Description	0	Enabled	1 = Both run enable (see par. 20.12) and start enable (20.19) signals are present. Note: This bit is not affected by the presence of a fault.	1	Inhibited	1 = Start inhibited. See parameters 06.18 and 06.25 for the source of the inhibiting signal.	2	DC charged	1 = DC circuit has been charged	3	Ready to start	1 = Drive is ready to receive a start command	4	Following reference	1 = Drive is ready to follow given reference	5	Started	1 = Drive has been started	6	Modulating	1 = Drive is modulating (output stage is being controlled)	7	Limiting	1 = Any operating limit (speed, torque, etc.) is active	8	Local control	1 = Drive is in local control	9	Network ctrl	1 = Drive is in <i>network control</i> (see page 14)	10	Ext1 active	1 = Control location EXT1 active	11	Ext2 active	1 = Control location EXT2 active	12	Reserved		13	Start request	1 = Start requested	14...15	Reserved		
Bit	Name	Description																																																	
0	Enabled	1 = Both run enable (see par. 20.12) and start enable (20.19) signals are present. Note: This bit is not affected by the presence of a fault.																																																	
1	Inhibited	1 = Start inhibited. See parameters 06.18 and 06.25 for the source of the inhibiting signal.																																																	
2	DC charged	1 = DC circuit has been charged																																																	
3	Ready to start	1 = Drive is ready to receive a start command																																																	
4	Following reference	1 = Drive is ready to follow given reference																																																	
5	Started	1 = Drive has been started																																																	
6	Modulating	1 = Drive is modulating (output stage is being controlled)																																																	
7	Limiting	1 = Any operating limit (speed, torque, etc.) is active																																																	
8	Local control	1 = Drive is in local control																																																	
9	Network ctrl	1 = Drive is in <i>network control</i> (see page 14)																																																	
10	Ext1 active	1 = Control location EXT1 active																																																	
11	Ext2 active	1 = Control location EXT2 active																																																	
12	Reserved																																																		
13	Start request	1 = Start requested																																																	
14...15	Reserved																																																		
	0000h...FFFFh	Drive status word 1.	1 = 1																																																

No.	Name/Value	Description	Def/FbEq16																																																
06.17	<i>Drive status word 2</i>	Drive status word 2. This parameter is read-only.	-																																																
		<table border="1"> <thead> <tr> <th>Bit</th> <th>Name</th> <th>Description</th> </tr> </thead> <tbody> <tr> <td>0</td> <td>Identification run done</td> <td>1 = Motor identification (ID) run has been performed</td> </tr> <tr> <td>1</td> <td>Magnetized</td> <td>1 = The motor has been magnetized</td> </tr> <tr> <td>2</td> <td>Torque control</td> <td>1 = Torque control mode active</td> </tr> <tr> <td>3</td> <td>Speed control</td> <td>1 = Speed control mode active</td> </tr> <tr> <td>4</td> <td>Power control</td> <td>1 = Power control mode active</td> </tr> <tr> <td>5</td> <td>Safe reference active</td> <td>1 = A "safe" reference is being applied by functions such as parameters 49.05 and 50.02</td> </tr> <tr> <td>6</td> <td>Last speed active</td> <td>1 = A "last speed" reference is being applied by functions such as parameters 49.05 and 50.02</td> </tr> <tr> <td>7</td> <td>Loss of reference</td> <td>1 = Reference signal lost</td> </tr> <tr> <td>8</td> <td>Emergency stop failed</td> <td>1 = Emergency stop failed (see parameters 31.32 and 31.33)</td> </tr> <tr> <td>9</td> <td>Jogging active</td> <td>1 = Jogging enable signal is on</td> </tr> <tr> <td>10</td> <td>Above limit</td> <td>1 = Actual speed, frequency or torque equals or exceeds limit (defined by parameters 46.31...46.33). Valid in both directions of rotation.</td> </tr> <tr> <td>11</td> <td>Emergency stop active</td> <td>1 = An emergency stop command signal is active, or the drive is stopping after receiving an emergency stop command.</td> </tr> <tr> <td>12...13</td> <td>Reserved</td> <td></td> </tr> <tr> <td>14</td> <td>Stop failed</td> <td>1 = Stopping failed (see parameters 31.37 and 31.38)</td> </tr> <tr> <td>15</td> <td>Reserved</td> <td></td> </tr> </tbody> </table>	Bit	Name	Description	0	Identification run done	1 = Motor identification (ID) run has been performed	1	Magnetized	1 = The motor has been magnetized	2	Torque control	1 = Torque control mode active	3	Speed control	1 = Speed control mode active	4	Power control	1 = Power control mode active	5	Safe reference active	1 = A "safe" reference is being applied by functions such as parameters 49.05 and 50.02	6	Last speed active	1 = A "last speed" reference is being applied by functions such as parameters 49.05 and 50.02	7	Loss of reference	1 = Reference signal lost	8	Emergency stop failed	1 = Emergency stop failed (see parameters 31.32 and 31.33)	9	Jogging active	1 = Jogging enable signal is on	10	Above limit	1 = Actual speed, frequency or torque equals or exceeds limit (defined by parameters 46.31 ... 46.33). Valid in both directions of rotation.	11	Emergency stop active	1 = An emergency stop command signal is active, or the drive is stopping after receiving an emergency stop command.	12...13	Reserved		14	Stop failed	1 = Stopping failed (see parameters 31.37 and 31.38)	15	Reserved		
Bit	Name	Description																																																	
0	Identification run done	1 = Motor identification (ID) run has been performed																																																	
1	Magnetized	1 = The motor has been magnetized																																																	
2	Torque control	1 = Torque control mode active																																																	
3	Speed control	1 = Speed control mode active																																																	
4	Power control	1 = Power control mode active																																																	
5	Safe reference active	1 = A "safe" reference is being applied by functions such as parameters 49.05 and 50.02																																																	
6	Last speed active	1 = A "last speed" reference is being applied by functions such as parameters 49.05 and 50.02																																																	
7	Loss of reference	1 = Reference signal lost																																																	
8	Emergency stop failed	1 = Emergency stop failed (see parameters 31.32 and 31.33)																																																	
9	Jogging active	1 = Jogging enable signal is on																																																	
10	Above limit	1 = Actual speed, frequency or torque equals or exceeds limit (defined by parameters 46.31 ... 46.33). Valid in both directions of rotation.																																																	
11	Emergency stop active	1 = An emergency stop command signal is active, or the drive is stopping after receiving an emergency stop command.																																																	
12...13	Reserved																																																		
14	Stop failed	1 = Stopping failed (see parameters 31.37 and 31.38)																																																	
15	Reserved																																																		
	0000h...FFFFh	Drive status word 2.	1 = 1																																																

No.	Name/Value	Description	Def/FbEq16																																																			
06.18	<i>Start inhibit status word</i>	<p>Start inhibit status word. This word specifies the source of the inhibiting signal that is preventing the drive from starting.</p> <p>The conditions marked with an asterisk (*) only require that the start command is cycled. In all other instances, the inhibiting condition must be removed first.</p> <p>See also parameter <i>06.25 Drive inhibit status word 2</i>, and <i>06.16 Drive status word 1</i>, bit 1.</p> <p>This parameter is read-only.</p>	-																																																			
<table border="1"> <thead> <tr> <th>Bit</th> <th>Name</th> <th>Description</th> </tr> </thead> <tbody> <tr> <td>0</td> <td>Not ready run</td> <td>1 = DC voltage is missing or drive has not been parametrized correctly. Check the parameters in groups 95 and 99.</td> </tr> <tr> <td>1</td> <td>Ctrl location changed</td> <td>* 1 = Control location has changed</td> </tr> <tr> <td>2</td> <td>SSW inhibit</td> <td>1 = Control program is keeping itself in inhibited state</td> </tr> <tr> <td>3</td> <td>Fault reset</td> <td>* 1 = A fault has been reset</td> </tr> <tr> <td>4</td> <td>Lost start enable</td> <td>1 = Start enable signal missing</td> </tr> <tr> <td>5</td> <td>Lost run enable</td> <td>1 = Run enable signal missing</td> </tr> <tr> <td>6</td> <td>FSO inhibit</td> <td>1 = Operation prevented by FSO-xx safety functions module</td> </tr> <tr> <td>7</td> <td>STO</td> <td>1 = Safe torque off active</td> </tr> <tr> <td>8</td> <td>Current calibration ended</td> <td>* 1 = Current calibration routine has finished</td> </tr> <tr> <td>9</td> <td>ID run ended</td> <td>* 1 = Motor identification run has finished</td> </tr> <tr> <td>10</td> <td>Auto phase ended</td> <td>* 1 = Autophasing routine has finished</td> </tr> <tr> <td>11</td> <td>Em Off1</td> <td>1 = Emergency stop signal (mode Off1)</td> </tr> <tr> <td>12</td> <td>Em Off2</td> <td>1 = Emergency stop signal (mode Off2)</td> </tr> <tr> <td>13</td> <td>Em Off3</td> <td>1 = Emergency stop signal (mode Off3)</td> </tr> <tr> <td>14</td> <td>Auto reset inhibit</td> <td>1 = The autoreset function is inhibiting operation</td> </tr> <tr> <td>15</td> <td>Jogging active</td> <td>1 = The jogging enable signal is inhibiting operation</td> </tr> </tbody> </table>				Bit	Name	Description	0	Not ready run	1 = DC voltage is missing or drive has not been parametrized correctly. Check the parameters in groups 95 and 99.	1	Ctrl location changed	* 1 = Control location has changed	2	SSW inhibit	1 = Control program is keeping itself in inhibited state	3	Fault reset	* 1 = A fault has been reset	4	Lost start enable	1 = Start enable signal missing	5	Lost run enable	1 = Run enable signal missing	6	FSO inhibit	1 = Operation prevented by FSO-xx safety functions module	7	STO	1 = Safe torque off active	8	Current calibration ended	* 1 = Current calibration routine has finished	9	ID run ended	* 1 = Motor identification run has finished	10	Auto phase ended	* 1 = Autophasing routine has finished	11	Em Off1	1 = Emergency stop signal (mode Off1)	12	Em Off2	1 = Emergency stop signal (mode Off2)	13	Em Off3	1 = Emergency stop signal (mode Off3)	14	Auto reset inhibit	1 = The autoreset function is inhibiting operation	15	Jogging active	1 = The jogging enable signal is inhibiting operation
Bit	Name	Description																																																				
0	Not ready run	1 = DC voltage is missing or drive has not been parametrized correctly. Check the parameters in groups 95 and 99.																																																				
1	Ctrl location changed	* 1 = Control location has changed																																																				
2	SSW inhibit	1 = Control program is keeping itself in inhibited state																																																				
3	Fault reset	* 1 = A fault has been reset																																																				
4	Lost start enable	1 = Start enable signal missing																																																				
5	Lost run enable	1 = Run enable signal missing																																																				
6	FSO inhibit	1 = Operation prevented by FSO-xx safety functions module																																																				
7	STO	1 = Safe torque off active																																																				
8	Current calibration ended	* 1 = Current calibration routine has finished																																																				
9	ID run ended	* 1 = Motor identification run has finished																																																				
10	Auto phase ended	* 1 = Autophasing routine has finished																																																				
11	Em Off1	1 = Emergency stop signal (mode Off1)																																																				
12	Em Off2	1 = Emergency stop signal (mode Off2)																																																				
13	Em Off3	1 = Emergency stop signal (mode Off3)																																																				
14	Auto reset inhibit	1 = The autoreset function is inhibiting operation																																																				
15	Jogging active	1 = The jogging enable signal is inhibiting operation																																																				
	0000h...FFFFh	Start inhibit status word.	1 = 1																																																			

No.	Name/Value	Description	Def/FbEq16																																				
06.19	<i>Speed control status word</i>	Speed control status word. This parameter is read-only.	-																																				
		<table border="1"> <thead> <tr> <th>Bit</th> <th>Name</th> <th>Description</th> </tr> </thead> <tbody> <tr> <td>0</td> <td>Zero speed</td> <td>1 = Drive is running at zero speed, ie. the absolute value of par. 90.01 Motor speed for control has remained below 21.06 Zero speed limit for longer than 21.07 Zero speed delay. Notes: During a ramp stop when the drive is running forward, the delay count runs whenever $[90.01] < [21.06]$. From the reverse direction, the delay count runs whenever $90.01 > -[21.06]$.</td> </tr> <tr> <td>1</td> <td>Forward</td> <td>1 = Drive is running in forward direction above zero speed limit, ie. $[90.01] > +[21.06]$.</td> </tr> <tr> <td>2</td> <td>Reverse</td> <td>1 = Drive is running in reverse direction above zero speed limit, ie. $[90.01] < -[21.06]$.</td> </tr> <tr> <td>3</td> <td>Out of window</td> <td>1 = Speed error window control active (see par. 24.41)</td> </tr> <tr> <td>4</td> <td>Internal speed feedback</td> <td>1 = Estimated speed feedback used in motor control, ie. estimated speed is selected by par. 90.41 or 90.46, or selected encoder has faulted (par. 90.45) 0 = Encoder 1 or 2 is used for speed feedback.</td> </tr> <tr> <td>5</td> <td>Encoder 1 feedback</td> <td>1 = Encoder 1 used for speed feedback in motor control 0 = Encoder 1 faulted or not selected as source of speed feedback (see par. 90.41 and 90.46)</td> </tr> <tr> <td>6</td> <td>Encoder 2 feedback</td> <td>1 = Encoder 2 used for speed feedback in motor control 0 = Encoder 2 faulted or not selected as source of speed feedback (see par. 90.41 and 90.46)</td> </tr> <tr> <td>7</td> <td>Any constant speed request</td> <td>1 = A constant speed or frequency has been selected; see par. 06.20.</td> </tr> <tr> <td>8</td> <td>Follower speed corr min lim</td> <td>1 = Minimum limit of speed correction (in a speed-controlled follower) has been reached (see par. 23.39...23.41).</td> </tr> <tr> <td>9</td> <td>Follower speed corr max lim</td> <td>1 = Maximum limit of speed correction (in a speed-controlled follower) has been reached (see par. 23.39...23.41).</td> </tr> <tr> <td>10...15</td> <td>Reserved</td> <td></td> </tr> </tbody> </table>	Bit	Name	Description	0	Zero speed	1 = Drive is running at zero speed, ie. the absolute value of par. 90.01 Motor speed for control has remained below 21.06 Zero speed limit for longer than 21.07 Zero speed delay . Notes: During a ramp stop when the drive is running forward, the delay count runs whenever $[90.01] < [21.06]$. From the reverse direction, the delay count runs whenever $90.01 > -[21.06]$.	1	Forward	1 = Drive is running in forward direction above zero speed limit, ie. $[90.01] > +[21.06]$.	2	Reverse	1 = Drive is running in reverse direction above zero speed limit, ie. $[90.01] < -[21.06]$.	3	Out of window	1 = Speed error window control active (see par. 24.41)	4	Internal speed feedback	1 = Estimated speed feedback used in motor control, ie. estimated speed is selected by par. 90.41 or 90.46 , or selected encoder has faulted (par. 90.45) 0 = Encoder 1 or 2 is used for speed feedback.	5	Encoder 1 feedback	1 = Encoder 1 used for speed feedback in motor control 0 = Encoder 1 faulted or not selected as source of speed feedback (see par. 90.41 and 90.46)	6	Encoder 2 feedback	1 = Encoder 2 used for speed feedback in motor control 0 = Encoder 2 faulted or not selected as source of speed feedback (see par. 90.41 and 90.46)	7	Any constant speed request	1 = A constant speed or frequency has been selected; see par. 06.20 .	8	Follower speed corr min lim	1 = Minimum limit of speed correction (in a speed-controlled follower) has been reached (see par. 23.39...23.41).	9	Follower speed corr max lim	1 = Maximum limit of speed correction (in a speed-controlled follower) has been reached (see par. 23.39...23.41).	10...15	Reserved		
Bit	Name	Description																																					
0	Zero speed	1 = Drive is running at zero speed, ie. the absolute value of par. 90.01 Motor speed for control has remained below 21.06 Zero speed limit for longer than 21.07 Zero speed delay . Notes: During a ramp stop when the drive is running forward, the delay count runs whenever $[90.01] < [21.06]$. From the reverse direction, the delay count runs whenever $90.01 > -[21.06]$.																																					
1	Forward	1 = Drive is running in forward direction above zero speed limit, ie. $[90.01] > +[21.06]$.																																					
2	Reverse	1 = Drive is running in reverse direction above zero speed limit, ie. $[90.01] < -[21.06]$.																																					
3	Out of window	1 = Speed error window control active (see par. 24.41)																																					
4	Internal speed feedback	1 = Estimated speed feedback used in motor control, ie. estimated speed is selected by par. 90.41 or 90.46 , or selected encoder has faulted (par. 90.45) 0 = Encoder 1 or 2 is used for speed feedback.																																					
5	Encoder 1 feedback	1 = Encoder 1 used for speed feedback in motor control 0 = Encoder 1 faulted or not selected as source of speed feedback (see par. 90.41 and 90.46)																																					
6	Encoder 2 feedback	1 = Encoder 2 used for speed feedback in motor control 0 = Encoder 2 faulted or not selected as source of speed feedback (see par. 90.41 and 90.46)																																					
7	Any constant speed request	1 = A constant speed or frequency has been selected; see par. 06.20 .																																					
8	Follower speed corr min lim	1 = Minimum limit of speed correction (in a speed-controlled follower) has been reached (see par. 23.39...23.41).																																					
9	Follower speed corr max lim	1 = Maximum limit of speed correction (in a speed-controlled follower) has been reached (see par. 23.39...23.41).																																					
10...15	Reserved																																						
	0000h...FFFFh	Speed control status word.	1 = 1																																				

No.	Name/Value	Description	Def/FbEq16																											
06.20	<i>Constant speed status word</i>	Constant speed/frequency status word. Indicates which constant speed or frequency is active (if any). See also parameter <i>06.19 Speed control status word</i> , bit 7, and section <i>Constant speeds/frequencies</i> (page 46). This parameter is read-only.	-																											
<table border="1"> <thead> <tr> <th>Bit</th> <th>Name</th> <th>Description</th> </tr> </thead> <tbody> <tr> <td>0</td> <td>Constant speed 1</td> <td>1 = Constant speed or frequency 1 selected</td> </tr> <tr> <td>1</td> <td>Constant speed 2</td> <td>1 = Constant speed or frequency 2 selected</td> </tr> <tr> <td>2</td> <td>Constant speed 3</td> <td>1 = Constant speed or frequency 3 selected</td> </tr> <tr> <td>3</td> <td>Constant speed 4</td> <td>1 = Constant speed or frequency 4 selected</td> </tr> <tr> <td>4</td> <td>Constant speed 5</td> <td>1 = Constant speed or frequency 5 selected</td> </tr> <tr> <td>5</td> <td>Constant speed 6</td> <td>1 = Constant speed or frequency 6 selected</td> </tr> <tr> <td>6</td> <td>Constant speed 7</td> <td>1 = Constant speed or frequency 7 selected</td> </tr> <tr> <td>7...15</td> <td>Reserved</td> <td></td> </tr> </tbody> </table>				Bit	Name	Description	0	Constant speed 1	1 = Constant speed or frequency 1 selected	1	Constant speed 2	1 = Constant speed or frequency 2 selected	2	Constant speed 3	1 = Constant speed or frequency 3 selected	3	Constant speed 4	1 = Constant speed or frequency 4 selected	4	Constant speed 5	1 = Constant speed or frequency 5 selected	5	Constant speed 6	1 = Constant speed or frequency 6 selected	6	Constant speed 7	1 = Constant speed or frequency 7 selected	7...15	Reserved	
Bit	Name	Description																												
0	Constant speed 1	1 = Constant speed or frequency 1 selected																												
1	Constant speed 2	1 = Constant speed or frequency 2 selected																												
2	Constant speed 3	1 = Constant speed or frequency 3 selected																												
3	Constant speed 4	1 = Constant speed or frequency 4 selected																												
4	Constant speed 5	1 = Constant speed or frequency 5 selected																												
5	Constant speed 6	1 = Constant speed or frequency 6 selected																												
6	Constant speed 7	1 = Constant speed or frequency 7 selected																												
7...15	Reserved																													
	0000h...FFFFh	Constant speed/frequency status word.	1 = 1																											
06.21	<i>Drive status word 3</i>	Drive status word 3. This parameter is read-only.	-																											
<table border="1"> <thead> <tr> <th>Bit</th> <th>Name</th> <th>Description</th> </tr> </thead> <tbody> <tr> <td>0</td> <td>DC hold active</td> <td>1 = DC hold is active (see par. <i>21.08</i>)</td> </tr> <tr> <td>1</td> <td>Post-magnetizing active</td> <td>1 = Post-magnetizing is active (see par. <i>21.08</i>)</td> </tr> <tr> <td>2</td> <td>Motor pre-heating active</td> <td>1 = Motor pre-heating is active (see par. <i>21.14</i>)</td> </tr> <tr> <td>3</td> <td>PM smooth start active</td> <td>Reserved.</td> </tr> <tr> <td>4...15</td> <td>Reserved</td> <td></td> </tr> </tbody> </table>				Bit	Name	Description	0	DC hold active	1 = DC hold is active (see par. <i>21.08</i>)	1	Post-magnetizing active	1 = Post-magnetizing is active (see par. <i>21.08</i>)	2	Motor pre-heating active	1 = Motor pre-heating is active (see par. <i>21.14</i>)	3	PM smooth start active	Reserved.	4...15	Reserved										
Bit	Name	Description																												
0	DC hold active	1 = DC hold is active (see par. <i>21.08</i>)																												
1	Post-magnetizing active	1 = Post-magnetizing is active (see par. <i>21.08</i>)																												
2	Motor pre-heating active	1 = Motor pre-heating is active (see par. <i>21.14</i>)																												
3	PM smooth start active	Reserved.																												
4...15	Reserved																													
	0000h...FFFFh	Drive status word 3.	1 = 1																											

No.	Name/Value	Description	Def/FbEq16																					
06.25	<i>Drive inhibit status word 2</i>	Drive inhibit status word 2. This word specifies the source of the inhibiting signal that is preventing the drive from starting. See also parameter <i>06.18 Start inhibit status word</i> , and <i>06.16 Drive status word 1</i> , bit 1. This parameter is read-only.	-																					
<table border="1"> <thead> <tr> <th>Bit</th> <th>Name</th> <th>Description</th> </tr> </thead> <tbody> <tr> <td>0</td> <td>Follower drive</td> <td>1 = A follower is preventing the master from starting.</td> </tr> <tr> <td>1</td> <td>Application</td> <td>1 = The application program is preventing the drive from starting.</td> </tr> <tr> <td>2</td> <td>Aux. power failure</td> <td>1 = A control unit auxiliary power failure is preventing the drive from starting.</td> </tr> <tr> <td>3</td> <td>Encoder feedback</td> <td>1 = The encoder feedback configuration is preventing the drive from starting.</td> </tr> <tr> <td>4</td> <td>Ref source parametrization</td> <td>1 = A reference source parametrization conflict is preventing the drive from starting. See warning <i>A6DA Reference source parametrization</i> (page 491).</td> </tr> <tr> <td>5...15</td> <td>Reserved</td> <td></td> </tr> </tbody> </table>				Bit	Name	Description	0	Follower drive	1 = A follower is preventing the master from starting.	1	Application	1 = The application program is preventing the drive from starting.	2	Aux. power failure	1 = A control unit auxiliary power failure is preventing the drive from starting.	3	Encoder feedback	1 = The encoder feedback configuration is preventing the drive from starting.	4	Ref source parametrization	1 = A reference source parametrization conflict is preventing the drive from starting. See warning <i>A6DA Reference source parametrization</i> (page 491).	5...15	Reserved	
Bit	Name	Description																						
0	Follower drive	1 = A follower is preventing the master from starting.																						
1	Application	1 = The application program is preventing the drive from starting.																						
2	Aux. power failure	1 = A control unit auxiliary power failure is preventing the drive from starting.																						
3	Encoder feedback	1 = The encoder feedback configuration is preventing the drive from starting.																						
4	Ref source parametrization	1 = A reference source parametrization conflict is preventing the drive from starting. See warning <i>A6DA Reference source parametrization</i> (page 491).																						
5...15	Reserved																							
	0000h...FFFFh	Start inhibit status word.	1 = 1																					
06.29	<i>MSW bit 10 sel</i>	Selects a binary source whose status is transmitted as bit 10 of <i>06.11 Main status word</i> .	<i>Above limit</i>																					
	False	0.	0																					
	True	1.	1																					
	Above limit	Bit 10 of <i>06.17 Drive status word 2</i> (see page 110).	2																					
	<i>Other [bit]</i>	Source selection (see <i>Terms and abbreviations</i> on page 90).	-																					
06.30	<i>MSW bit 11 sel</i>	Selects a binary source whose status is transmitted as bit 11 of <i>06.11 Main status word</i> .	<i>Ext ctrl loc</i>																					
	False	0.	0																					
	True	1.	1																					
	Ext ctrl loc	Bit 11 of <i>06.01 Main control word</i> (see page 108).	2																					
	<i>Other [bit]</i>	Source selection (see <i>Terms and abbreviations</i> on page 90).	-																					
06.31	<i>MSW bit 12 sel</i>	Selects a binary source whose status is transmitted as bit 12 of <i>06.11 Main status word</i> .	<i>Ext run enable</i>																					
	False	0.	0																					
	True	1.	1																					
	Ext run enable	Inverted bit 5 of <i>06.18 Start inhibit status word</i> (see page 111).	2																					

No.	Name/Value	Description	Def/FbEq16
	<i>Other [bit]</i>	Source selection (see <i>Terms and abbreviations</i> on page 90).	-
06.32	<i>MSW bit 13 sel</i>	Selects a binary source whose status is transmitted as bit 13 of <i>06.11 Main status word</i> .	<i>False</i>
	False	0.	0
	True	1.	1
	<i>Other [bit]</i>	Source selection (see <i>Terms and abbreviations</i> on page 90).	-
06.33	<i>MSW bit 14 sel</i>	Selects a binary source whose status is transmitted as bit 14 of <i>06.11 Main status word</i> .	<i>False</i>
	False	0.	0
	True	1.	1
	<i>Other [bit]</i>	Source selection (see <i>Terms and abbreviations</i> on page 90).	-
06.45	<i>Follower CW user bit 0 selection</i>	Selects a binary source whose status is transmitted as bit 12 of the Follower control word to follower drives. (Bits 0...11 of the Follower control word are taken from <i>06.01 Main control word</i> .) See also section <i>Master/follower functionality</i> (page 39).	<i>MCW user bit 0</i>
	False	0.	0
	True	1.	1
	MCW user bit 0	Bit 12 of <i>06.01 Main control word</i> (see page 108).	2
	MCW user bit 1	Bit 13 of <i>06.01 Main control word</i> (see page 108).	3
	MCW user bit 2	Bit 14 of <i>06.01 Main control word</i> (see page 108).	4
	MCW user bit 3	Bit 15 of <i>06.01 Main control word</i> (see page 108).	5
	<i>Other [bit]</i>	Source selection (see <i>Terms and abbreviations</i> on page 90).	-
06.46	<i>Follower CW user bit 1 selection</i>	Selects a binary source whose status is transmitted as bit 13 of the Follower control word to follower drives. (Bits 0...11 of the Follower control word are taken from <i>06.01 Main control word</i> .)	<i>MCW user bit 1</i>
	False	0.	0
	True	1.	1
	MCW user bit 0	Bit 12 of <i>06.01 Main control word</i> (see page 108).	2
	MCW user bit 1	Bit 13 of <i>06.01 Main control word</i> (see page 108).	3
	MCW user bit 2	Bit 14 of <i>06.01 Main control word</i> (see page 108).	4
	MCW user bit 3	Bit 15 of <i>06.01 Main control word</i> (see page 108).	5
	<i>Other [bit]</i>	Source selection (see <i>Terms and abbreviations</i> on page 90).	-

No.	Name/Value	Description	Def/FbEq16															
06.47	Follower CW user bit 2 selection	Selects a binary source whose status is transmitted as bit 14 of the Follower control word to follower drives. (Bits 0...11 of the Follower control word are taken from 06.01 Main control word .)	MCW user bit 2															
	False	0.	0															
	True	1.	1															
	MCW user bit 0	Bit 12 of 06.01 Main control word (see page 108).	2															
	MCW user bit 1	Bit 13 of 06.01 Main control word (see page 108).	3															
	MCW user bit 2	Bit 14 of 06.01 Main control word (see page 108).	4															
	MCW user bit 3	Bit 15 of 06.01 Main control word (see page 108).	5															
	Other [bit]	Source selection (see Terms and abbreviations on page 90).	-															
06.48	Follower CW user bit 3 selection	Selects a binary source whose status is transmitted as bit 15 of the Follower control word to follower drives. (Bits 0...11 of the Follower control word are taken from 06.01 Main control word .)	MCW user bit 3															
	False	0.	0															
	True	1.	1															
	MCW user bit 0	Bit 12 of 06.01 Main control word (see page 108).	2															
	MCW user bit 1	Bit 13 of 06.01 Main control word (see page 108).	3															
	MCW user bit 2	Bit 14 of 06.01 Main control word (see page 108).	4															
	MCW user bit 3	Bit 15 of 06.01 Main control word (see page 108).	5															
	Other [bit]	Source selection (see Terms and abbreviations on page 90).	-															
06.50	User status word 1	User-defined status word. This word shows the status of the binary sources selected by parameters 06.60 ... 06.75 . This parameter is read-only.	-															
		<table border="1"> <thead> <tr> <th>Bit</th> <th>Name</th> <th>Description</th> </tr> </thead> <tbody> <tr> <td>0</td> <td>User status bit 0</td> <td>Status of source selected by parameter 06.60</td> </tr> <tr> <td>1</td> <td>User status bit 1</td> <td>Status of source selected by parameter 06.61</td> </tr> <tr> <td>...</td> <td>...</td> <td>...</td> </tr> <tr> <td>15</td> <td>User status bit 15</td> <td>Status of source selected by parameter 06.75</td> </tr> </tbody> </table>	Bit	Name	Description	0	User status bit 0	Status of source selected by parameter 06.60	1	User status bit 1	Status of source selected by parameter 06.61	15	User status bit 15	Status of source selected by parameter 06.75	
Bit	Name	Description																
0	User status bit 0	Status of source selected by parameter 06.60																
1	User status bit 1	Status of source selected by parameter 06.61																
...																
15	User status bit 15	Status of source selected by parameter 06.75																
	0000h...FFFFh	User-defined status word.	1 = 1															
06.60	User status word 1 bit 0 sel	Selects a binary source whose status is shown as bit 0 of 06.50 User status word 1 .	False															
	False	0.	0															
	True	1.	1															

No.	Name/Value	Description	Def/FbEq16
	<i>Other [bit]</i>	Source selection (see <i>Terms and abbreviations</i> on page 90).	-
06.61	<i>User status word 1 bit 1 sel</i>	Selects a binary source whose status is shown as bit 1 of 06.50 <i>User status word 1</i> .	<i>Out of window</i>
	False	0.	0
	True	1.	1
	Out of window	Bit 3 of 06.19 <i>Speed control status word</i> (see page 112).	2
	<i>Other [bit]</i>	Source selection (see <i>Terms and abbreviations</i> on page 90).	-
06.62	<i>User status word 1 bit 2 sel</i>	Selects a binary source whose status is shown as bit 2 of 06.50 <i>User status word 1</i> .	<i>Emergency stop failed</i>
	False	0.	0
	True	1.	1
	Emergency stop failed	Bit 8 of 06.17 <i>Drive status word 2</i> (see page 110).	2
	<i>Other [bit]</i>	Source selection (see <i>Terms and abbreviations</i> on page 90).	-
06.63	<i>User status word 1 bit 3 sel</i>	Selects a binary source whose status is shown as bit 3 of 06.50 <i>User status word 1</i> .	<i>Magnetized</i>
	False	0.	0
	True	1.	1
	Magnetized	Bit 1 of 06.17 <i>Drive status word 2</i> (see page 110).	2
	<i>Other [bit]</i>	Source selection (see <i>Terms and abbreviations</i> on page 90).	-
06.64	<i>User status word 1 bit 4 sel</i>	Selects a binary source whose status is shown as bit 4 of 06.50 <i>User status word 1</i> .	<i>Run disable</i>
	False	0.	0
	True	1.	1
	Run disable	Bit 5 of 06.18 <i>Start inhibit status word</i> (see page 111).	2
	<i>Other [bit]</i>	Source selection (see <i>Terms and abbreviations</i> on page 90).	-
06.65	<i>User status word 1 bit 5 sel</i>	Selects a binary source whose status is shown as bit 5 of 06.50 <i>User status word 1</i> .	<i>False</i>
	False	0.	0
	True	1.	1
	<i>Other [bit]</i>	Source selection (see <i>Terms and abbreviations</i> on page 90).	-

No.	Name/Value	Description	Def/FbEq16
06.66	<i>User status word 1 bit 6 sel</i>	Selects a binary source whose status is shown as bit 6 of <i>06.50 User status word 1</i> .	<i>False</i>
	False	0.	0
	True	1.	1
	<i>Other [bit]</i>	Source selection (see <i>Terms and abbreviations</i> on page 90).	-
06.67	<i>User status word 1 bit 7 sel</i>	Selects a binary source whose status is shown as bit 7 of <i>06.50 User status word 1</i> .	<i>Identification run done</i>
	False	0.	0
	True	1.	1
	Identification run done	Bit 0 of <i>06.17 Drive status word 2</i> (see page 110).	2
	<i>Other [bit]</i>	Source selection (see <i>Terms and abbreviations</i> on page 90).	-
06.68	<i>User status word 1 bit 8 sel</i>	Selects a binary source whose status is shown as bit 8 of <i>06.50 User status word 1</i> .	<i>Start inhibition</i>
	False	0.	0
	True	1.	1
	Start inhibition	Bit 7 of <i>06.18 Start inhibit status word</i> (see page 111).	2
	<i>Other [bit]</i>	Source selection (see <i>Terms and abbreviations</i> on page 90).	-
06.69	<i>User status word 1 bit 9 sel</i>	Selects a binary source whose status is shown as bit 9 of <i>06.50 User status word 1</i> .	<i>Limiting</i>
	False	0.	0
	True	1.	1
	Limiting	Bit 7 of <i>06.16 Drive status word 1</i> (see page 109).	2
	<i>Other [bit]</i>	Source selection (see <i>Terms and abbreviations</i> on page 90).	-
06.70	<i>User status word 1 bit 10 sel</i>	Selects a binary source whose status is shown as bit 10 of <i>06.50 User status word 1</i> .	<i>Torque control</i>
	False	0.	0
	True	1.	1
	Torque control	Bit 2 of <i>06.17 Drive status word 2</i> (see page 110).	2
	<i>Other [bit]</i>	Source selection (see <i>Terms and abbreviations</i> on page 90).	-
06.71	<i>User status word 1 bit 11 sel</i>	Selects a binary source whose status is shown as bit 11 of <i>06.50 User status word 1</i> .	<i>Zero speed</i>
	False	0.	0
	True	1.	1

No.	Name/Value	Description	Def/FbEq16																					
06.101	<i>User control word 2</i>	User-defined control word 2. This parameter is read-only.	-																					
<table border="1"> <thead> <tr> <th>Bit</th> <th>Name</th> <th>Description</th> </tr> </thead> <tbody> <tr> <td>0</td> <td>User control word 2 bit 0</td> <td>User-defined bit.</td> </tr> <tr> <td>1</td> <td>User control word 2 bit 1</td> <td>User-defined bit.</td> </tr> <tr> <td>...</td> <td>...</td> <td>...</td> </tr> <tr> <td>15</td> <td>User control word 2 bit 15</td> <td>User-defined bit.</td> </tr> </tbody> </table>				Bit	Name	Description	0	User control word 2 bit 0	User-defined bit.	1	User control word 2 bit 1	User-defined bit.	15	User control word 2 bit 15	User-defined bit.						
Bit	Name	Description																						
0	User control word 2 bit 0	User-defined bit.																						
1	User control word 2 bit 1	User-defined bit.																						
...																						
15	User control word 2 bit 15	User-defined bit.																						
0000h...FFFFh		User-defined control word 2.	1 = 1																					
07 System info		Drive hardware and firmware information. All parameters in this group are read-only.																						
07.03	<i>Drive rating id</i>	Type of the drive/inverter unit.	-																					
07.04	<i>Firmware name</i>	Firmware identification.	-																					
07.05	<i>Firmware version</i>	Version number of the firmware.	-																					
07.06	<i>Loading package name</i>	Name of the firmware loading package.	-																					
07.07	<i>Loading package version</i>	Version number of the firmware loading package.	-																					
07.08	<i>Bootloader version</i>	Version number of the firmware bootloader.	-																					
07.11	<i>Cpu usage</i>	Microprocessor load in percent.	-																					
0...100%		Microprocessor load.	1 = 1%																					
07.13	<i>PU logic version number</i>	Version number of the power unit logic.	-																					
07.21	<i>Application environment status 1</i>	Shows which tasks of the application program are running. See the <i>Drive (IEC 61131-3) application programming manual (3AUA0000127808 [English])</i> .	-																					
<table border="1"> <thead> <tr> <th>Bit</th> <th>Name</th> <th>Description</th> </tr> </thead> <tbody> <tr> <td>0</td> <td>Pre task</td> <td>1 = Pre-task running.</td> </tr> <tr> <td>1</td> <td>Appl task1</td> <td>1 = Task 1 running.</td> </tr> <tr> <td>2</td> <td>Appl task2</td> <td>1 = Task 2 running.</td> </tr> <tr> <td>3</td> <td>Appl task3</td> <td>1 = Task 3 running.</td> </tr> <tr> <td>4...14</td> <td>Reserved</td> <td></td> </tr> <tr> <td>15</td> <td>Task monitoring</td> <td>1 = Task monitoring enabled.</td> </tr> </tbody> </table>				Bit	Name	Description	0	Pre task	1 = Pre-task running.	1	Appl task1	1 = Task 1 running.	2	Appl task2	1 = Task 2 running.	3	Appl task3	1 = Task 3 running.	4...14	Reserved		15	Task monitoring	1 = Task monitoring enabled.
Bit	Name	Description																						
0	Pre task	1 = Pre-task running.																						
1	Appl task1	1 = Task 1 running.																						
2	Appl task2	1 = Task 2 running.																						
3	Appl task3	1 = Task 3 running.																						
4...14	Reserved																							
15	Task monitoring	1 = Task monitoring enabled.																						
0000h...FFFFh		Application program task status.	1 = 1																					

No.	Name/Value	Description	Def/FbEq16															
07.22	<i>Application environment status 2</i>	Shows the status of the openings in the application program. See the <i>Drive (IEC 61131-3) application programming manual</i> (3AUA0000127808 [English]).	-															
<table border="1"> <thead> <tr> <th>Bit</th> <th>Name</th> <th>Description</th> </tr> </thead> <tbody> <tr> <td>0</td> <td>Opening1</td> <td>Status of opening 1 in the application program.</td> </tr> <tr> <td>1</td> <td>Opening2</td> <td>Status of opening 2 in the application program.</td> </tr> <tr> <td>...</td> <td>...</td> <td>...</td> </tr> <tr> <td>15</td> <td>Opening16</td> <td>Status of opening 16 in the application program.</td> </tr> </tbody> </table>				Bit	Name	Description	0	Opening1	Status of opening 1 in the application program.	1	Opening2	Status of opening 2 in the application program.	15	Opening16	Status of opening 16 in the application program.
Bit	Name	Description																
0	Opening1	Status of opening 1 in the application program.																
1	Opening2	Status of opening 2 in the application program.																
...																
15	Opening16	Status of opening 16 in the application program.																
	0000h...FFFFh	Application program opening status.	1 = 1															
07.23	<i>Application name</i>	First five ASCII letters of the name given to the application program in the programming tool. The full name is visible under System info on the control panel or the Drive composer PC tool. _N/A_ = None.	-															
07.24	<i>Application version</i>	Application program version number given to the application program in the programming tool. Also visible under System info on the control panel or the Drive composer PC tool.	-															
07.25	<i>Customization package name</i>	First five ASCII letters of the name given to the customization package. The full name is visible under System info on the control panel or the Drive composer PC tool. _N/A_ = None.	-															
07.26	<i>Customization package version</i>	Customization package version number. Also visible under System info on the control panel or the Drive composer PC tool.	-															

No.	Name/Value	Description	Def/FbEq16																								
07.21	<i>Application environment status 1</i>	Shows which tasks of the application program are running. See the <i>Drive (IEC 61131-3) application programming manual (3AUA0000127808 [English])</i> .	-																								
<table border="1"> <thead> <tr> <th>Bit</th> <th>Name</th> <th>Description</th> </tr> </thead> <tbody> <tr> <td>0</td> <td>Pre task</td> <td>1 = Pre-task running</td> </tr> <tr> <td>1</td> <td>Appl task1</td> <td>1 = Task 1 running</td> </tr> <tr> <td>2</td> <td>Appl task2</td> <td>1 = Task 2 running</td> </tr> <tr> <td>3</td> <td>Appl task3</td> <td>1 = Task 3 running</td> </tr> <tr> <td>4...14</td> <td colspan="2">Reserved</td> </tr> <tr> <td>15</td> <td>Task monitoring</td> <td>1 = Task monitoring enabled</td> </tr> </tbody> </table>				Bit	Name	Description	0	Pre task	1 = Pre-task running	1	Appl task1	1 = Task 1 running	2	Appl task2	1 = Task 2 running	3	Appl task3	1 = Task 3 running	4...14	Reserved		15	Task monitoring	1 = Task monitoring enabled			
Bit	Name	Description																									
0	Pre task	1 = Pre-task running																									
1	Appl task1	1 = Task 1 running																									
2	Appl task2	1 = Task 2 running																									
3	Appl task3	1 = Task 3 running																									
4...14	Reserved																										
15	Task monitoring	1 = Task monitoring enabled																									
	0000h...FFFFh	Application program task status.	1 = 1																								
07.30	<i>Adaptive program status</i>	Shows the status of the adaptive program. See section <i>Adaptive programming</i> (page 33).	-																								
<table border="1"> <thead> <tr> <th>Bit</th> <th>Name</th> <th>Description</th> </tr> </thead> <tbody> <tr> <td>0</td> <td>Initialized</td> <td>1 = Adaptive program initialized</td> </tr> <tr> <td>1</td> <td>Editing</td> <td>1 = Adaptive program is being edited</td> </tr> <tr> <td>2</td> <td>Edit done</td> <td>1 = Editing of adaptive program finished</td> </tr> <tr> <td>3</td> <td>Running</td> <td>1 = Adaptive program running</td> </tr> <tr> <td>4...13</td> <td colspan="2">Reserved</td> </tr> <tr> <td>14</td> <td>State changing</td> <td>1 = State change in progress in adaptive programming engine</td> </tr> <tr> <td>15</td> <td>Faulted</td> <td>1 = Error in adaptive program</td> </tr> </tbody> </table>				Bit	Name	Description	0	Initialized	1 = Adaptive program initialized	1	Editing	1 = Adaptive program is being edited	2	Edit done	1 = Editing of adaptive program finished	3	Running	1 = Adaptive program running	4...13	Reserved		14	State changing	1 = State change in progress in adaptive programming engine	15	Faulted	1 = Error in adaptive program
Bit	Name	Description																									
0	Initialized	1 = Adaptive program initialized																									
1	Editing	1 = Adaptive program is being edited																									
2	Edit done	1 = Editing of adaptive program finished																									
3	Running	1 = Adaptive program running																									
4...13	Reserved																										
14	State changing	1 = State change in progress in adaptive programming engine																									
15	Faulted	1 = Error in adaptive program																									
	0000h...FFFFh	Adaptive program status.	1 = 1																								
10 Standard DI, RO		Configuration of digital inputs and relay outputs.																									
10.01	<i>DI status</i>	Displays the electrical status of digital inputs DI1L and DI6...DI1. The activation/deactivation delays of the inputs (if any are specified) are ignored. A filtering time can be defined by parameter <i>10.51 DI filter time</i> . Bits 0...5 reflect the status of DI1...DI6; bit 15 reflects the status of the DI1L input. Example: 1000000000010011b = DI1L, DI5, DI2 and DI1 are on, DI3, DI4 and DI6 are off. This parameter is read-only.	-																								
	0000h...FFFFh	Status of digital inputs.	1 = 1																								

No.	Name/Value	Description	Def/FbEq16																		
10.02	DI delayed status	Displays the status of digital inputs DIIL and DI6...DI1. This word is updated only after activation/deactivation delays (if any are specified). Bits 0...5 reflect the delayed status of DI1...DI6; bit 15 reflects the delayed status of the DIIL input. This parameter is read-only.	-																		
	0000h...FFFFh	Delayed status of digital inputs.	1 = 1																		
10.03	DI force selection	The electrical statuses of the digital inputs can be overridden for eg. testing purposes. A bit in parameter 10.04 DI force data is provided for each digital input, and its value is applied whenever the corresponding bit in this parameter is 1.	0000h																		
<table border="1"> <thead> <tr> <th>Bit</th> <th>Value</th> </tr> </thead> <tbody> <tr> <td>0</td> <td>1 = Force DI1 to value of bit 0 of parameter 10.04 DI force data.</td> </tr> <tr> <td>1</td> <td>1 = Force DI2 to value of bit 1 of parameter 10.04 DI force data.</td> </tr> <tr> <td>2</td> <td>1 = Force DI3 to value of bit 2 of parameter 10.04 DI force data.</td> </tr> <tr> <td>3</td> <td>1 = Force DI4 to value of bit 3 of parameter 10.04 DI force data.</td> </tr> <tr> <td>4</td> <td>1 = Force DI5 to value of bit 4 of parameter 10.04 DI force data.</td> </tr> <tr> <td>5</td> <td>1 = Force DI6 to value of bit 5 of parameter 10.04 DI force data.</td> </tr> <tr> <td>6...14</td> <td>Reserved</td> </tr> <tr> <td>15</td> <td>1 = Force DIIL to value of bit 15 of parameter 10.04 DI force data.</td> </tr> </tbody> </table>				Bit	Value	0	1 = Force DI1 to value of bit 0 of parameter 10.04 DI force data .	1	1 = Force DI2 to value of bit 1 of parameter 10.04 DI force data .	2	1 = Force DI3 to value of bit 2 of parameter 10.04 DI force data .	3	1 = Force DI4 to value of bit 3 of parameter 10.04 DI force data .	4	1 = Force DI5 to value of bit 4 of parameter 10.04 DI force data .	5	1 = Force DI6 to value of bit 5 of parameter 10.04 DI force data .	6...14	Reserved	15	1 = Force DIIL to value of bit 15 of parameter 10.04 DI force data .
Bit	Value																				
0	1 = Force DI1 to value of bit 0 of parameter 10.04 DI force data .																				
1	1 = Force DI2 to value of bit 1 of parameter 10.04 DI force data .																				
2	1 = Force DI3 to value of bit 2 of parameter 10.04 DI force data .																				
3	1 = Force DI4 to value of bit 3 of parameter 10.04 DI force data .																				
4	1 = Force DI5 to value of bit 4 of parameter 10.04 DI force data .																				
5	1 = Force DI6 to value of bit 5 of parameter 10.04 DI force data .																				
6...14	Reserved																				
15	1 = Force DIIL to value of bit 15 of parameter 10.04 DI force data .																				
	0000h...FFFFh	Override selection for digital inputs.	1 = 1																		
10.04	DI force data	Contains the values that the digital inputs are forced to when selected by 10.03 DI force selection . Bit 0 is the forced value for DI1; bit 15 is the forced value for the DIIL input.	0000h																		
	0000h...FFFFh	Forced values of digital inputs.	1 = 1																		

No.	Name/Value	Description	Def/FbEq16
10.05	<i>DI1 ON delay</i>	Defines the activation delay for digital input DI1.	0.0 s
<p> $t_{On} = 10.05 \text{ DI1 ON delay}$ $t_{Off} = 10.06 \text{ DI1 OFF delay}$ *Electrical status of digital input. Indicated by <i>10.01 DI status</i>. **Indicated by <i>10.02 DI delayed status</i>. </p>			
	0.0 ... 3000.0 s	Activation delay for DI1.	10 = 1 s
10.06	<i>DI1 OFF delay</i>	Defines the deactivation delay for digital input DI1. See parameter <i>10.05 DI1 ON delay</i> .	0.0 s
	0.0 ... 3000.0 s	Deactivation delay for DI1.	10 = 1 s
10.07	<i>DI2 ON delay</i>	Defines the activation delay for digital input DI2.	0.0 s
<p> $t_{On} = 10.07 \text{ DI2 ON delay}$ $t_{Off} = 10.08 \text{ DI2 OFF delay}$ *Electrical status of digital input. Indicated by <i>10.01 DI status</i>. **Indicated by <i>10.02 DI delayed status</i>. </p>			
	0.0 ... 3000.0 s	Activation delay for DI2.	10 = 1 s
10.08	<i>DI2 OFF delay</i>	Defines the deactivation delay for digital input DI2. See parameter <i>10.07 DI2 ON delay</i> .	0.0 s
	0.0 ... 3000.0 s	Deactivation delay for DI2.	10 = 1 s

No.	Name/Value	Description	Def/FbEq16
10.09	<i>DI3 ON delay</i>	Defines the activation delay for digital input DI3.	0.0 s
<p> $t_{On} = 10.09 \text{ DI3 ON delay}$ $t_{Off} = 10.10 \text{ DI3 OFF delay}$ *Electrical status of digital input. Indicated by 10.01 DI status. **Indicated by 10.02 DI delayed status. </p>			
	0.0 ... 3000.0 s	Activation delay for DI3.	10 = 1 s
10.10	<i>DI3 OFF delay</i>	Defines the deactivation delay for digital input DI3. See parameter 10.09 DI3 ON delay .	0.0 s
	0.0 ... 3000.0 s	Deactivation delay for DI3.	10 = 1 s
10.11	<i>DI4 ON delay</i>	Defines the activation delay for digital input DI4.	0.0 s
<p> $t_{On} = 10.11 \text{ DI4 ON delay}$ $t_{Off} = 10.12 \text{ DI4 OFF delay}$ *Electrical status of digital input. Indicated by 10.01 DI status. **Indicated by 10.02 DI delayed status. </p>			
	0.0 ... 3000.0 s	Activation delay for DI4.	10 = 1 s
10.12	<i>DI4 OFF delay</i>	Defines the deactivation delay for digital input DI4. See parameter 10.11 DI4 ON delay .	0.0 s
	0.0 ... 3000.0 s	Deactivation delay for DI4.	10 = 1 s

No.	Name/Value	Description	Def/FbEq16
10.13	<i>DI5 ON delay</i>	Defines the activation delay for digital input DI5.	0.0 s
<p> $t_{On} = 10.13$ <i>DI5 ON delay</i> $t_{Off} = 10.14$ <i>DI5 OFF delay</i> *Electrical status of digital input. Indicated by 10.01 DI status. **Indicated by 10.02 DI delayed status. </p>			
	0.0 ... 3000.0 s	Activation delay for DI5.	10 = 1 s
10.14	<i>DI5 OFF delay</i>	Defines the deactivation delay for digital input DI5. See parameter 10.13 DI5 ON delay .	0.0 s
	0.0 ... 3000.0 s	Deactivation delay for DI5.	10 = 1 s
10.15	<i>DI6 ON delay</i>	Defines the activation delay for digital input DI6.	0.0 s
<p> $t_{On} = 10.15$ <i>DI6 ON delay</i> $t_{Off} = 10.16$ <i>DI6 OFF delay</i> *Electrical status of digital input. Indicated by 10.01 DI status. **Indicated by 10.02 DI delayed status. </p>			
	0.0 ... 3000.0 s	Activation delay for DI6.	10 = 1 s
10.16	<i>DI6 OFF delay</i>	Defines the deactivation delay for digital input DI6. See parameter 10.15 DI6 ON delay .	0.0 s
	0.0 ... 3000.0 s	Deactivation delay for DI6.	10 = 1 s
10.21	<i>RO status</i>	Status of relay outputs RO8...RO1. Example: 00000001b = RO1 is energized, RO2...RO8 are de-energized.	-
	0000h...FFFFh	Status of relay outputs.	1 = 1

No.	Name/Value	Description	Def/FbEq16
10.24	<i>RO1 source</i>	Selects a drive signal to be connected to relay output RO1.	<i>Ready run</i> ; 10.01 b3 (-1) (95.20 b2); 35.105 b1 (95.20 b6); 06.16 b6 (95.20 b9)
	Not energized	Output is not energized.	0
	Energized	Output is energized.	1
	Ready run	Bit 1 of <i>06.11 Main status word</i> (see page 108).	2
	Enabled	Bit 0 of <i>06.16 Drive status word 1</i> (see page 109).	4
	Started	Bit 5 of <i>06.16 Drive status word 1</i> (see page 109).	5
	Magnetized	Bit 1 of <i>06.17 Drive status word 2</i> (see page 110).	6
	Running	Bit 6 of <i>06.16 Drive status word 1</i> (see page 109).	7
	Ready ref	Bit 2 of <i>06.11 Main status word</i> (see page 108).	8
	At setpoint	Bit 8 of <i>06.11 Main status word</i> (see page 108).	9
	Reverse	Bit 2 of <i>06.19 Speed control status word</i> (see page 112).	10
	Zero speed	Bit 0 of <i>06.19 Speed control status word</i> (see page 112).	11
	Above limit	Bit 10 of <i>06.17 Drive status word 2</i> (see page 110).	12
	Warning	Bit 7 of <i>06.11 Main status word</i> (see page 108).	13
	Fault	Bit 3 of <i>06.11 Main status word</i> (see page 108).	14
	Fault (-1)	Inverted bit 3 of <i>06.11 Main status word</i> (see page 108).	15
	Ext2 active	Bit 11 of <i>06.16 Drive status word 1</i> (see page 109).	23
	Remote control	Bit 9 of <i>06.11 Main status word</i> (see page 108).	24
	Supervision 1	Bit 0 of <i>32.01 Supervision status</i> (see page 276).	33
	Supervision 2	Bit 1 of <i>32.01 Supervision status</i> (see page 276).	34
	Supervision 3	Bit 2 of <i>32.01 Supervision status</i> (see page 276).	35
	RO/DIO control word bit0	Bit 0 of <i>10.99 RO/DIO control word</i> (see page 129).	40
	RO/DIO control word bit1	Bit 1 of <i>10.99 RO/DIO control word</i> (see page 129).	41
	RO/DIO control word bit2	Bit 2 of <i>10.99 RO/DIO control word</i> (see page 129).	42
	RO/DIO control word bit8	Bit 8 of <i>10.99 RO/DIO control word</i> (see page 129).	43
	RO/DIO control word bit9	Bit 9 of <i>10.99 RO/DIO control word</i> (see page 129).	44

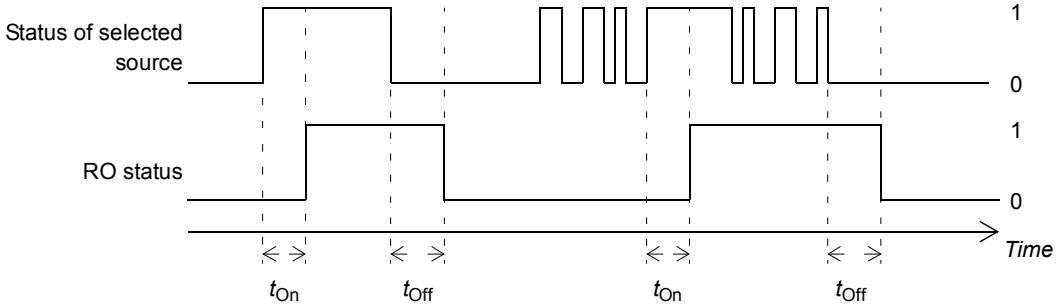
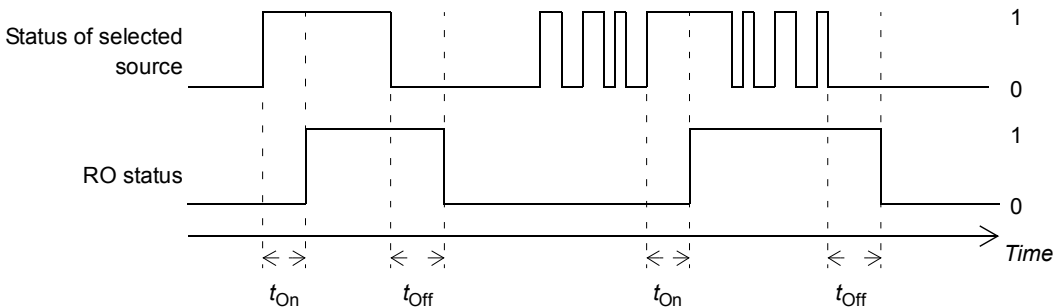
No.	Name/Value	Description	Def/FbEq16
	Other [bit]	Source selection (see Terms and abbreviations on page 90).	-
10.25	RO1 ON delay	Defines the activation delay for relay output RO1.	0.0 s
 <p data-bbox="232 748 514 808"> $t_{On} = 10.25 \text{ RO1 ON delay}$ $t_{Off} = 10.26 \text{ RO1 OFF delay}$ </p>			
	0.0 ... 3000.0 s	Activation delay for RO1.	10 = 1 s
10.26	RO1 OFF delay	Defines the deactivation delay for relay output RO1. See parameter 10.25 RO1 ON delay .	0.0 s
	0.0 ... 3000.0 s	Deactivation delay for RO1.	10 = 1 s
10.27	RO2 source	Selects a drive signal to be connected to relay output RO2. For the available selections, see parameter 10.24 RO1 source .	Running (95.20 b3)
10.28	RO2 ON delay	Defines the activation delay for relay output RO2.	0.0 s (95.20 b3)
 <p data-bbox="232 1621 514 1682"> $t_{On} = 10.28 \text{ RO2 ON delay}$ $t_{Off} = 10.29 \text{ RO2 OFF delay}$ </p>			
	0.0 ... 3000.0 s	Activation delay for RO2.	10 = 1 s
10.29	RO2 OFF delay	Defines the deactivation delay for relay output RO2. See parameter 10.28 RO2 ON delay .	0.0 s (95.20 b3)
	0.0 ... 3000.0 s	Deactivation delay for RO2.	10 = 1 s
10.30	RO3 source	Selects a drive signal to be connected to relay output RO3. For the available selections, see parameter 10.24 RO1 source .	Fault (-1)

No.	Name/Value	Description	Def/FbEq16																					
10.31	<i>RO3 ON delay</i>	Defines the activation delay for relay output RO3.	0.0 s																					
<p>$t_{On} = 10.31 \text{ RO3 ON delay}$ $t_{Off} = 10.32 \text{ RO3 OFF delay}$</p>																								
	0.0 ... 3000.0 s	Activation delay for RO3.	10 = 1 s																					
10.32	<i>RO3 OFF delay</i>	Defines the deactivation delay for relay output RO3. See parameter 10.31 RO3 ON delay .	0.0 s																					
	0.0 ... 3000.0 s	Deactivation delay for RO3.	10 = 1 s																					
10.51	<i>DI filter time</i>	Defines a filtering time for parameter 10.01 DI status .	10.0 ms																					
	0.3 ... 100.0 ms	Filtering time for 10.01 .	10 = 1 ms																					
10.99	<i>RO/DIO control word</i>	<p>Storage parameter for controlling the relay outputs and digital input/outputs eg. through the embedded fieldbus interface.</p> <p>To control the relay outputs (RO) and the digital input/outputs (DIO) of the drive, send a control word with the bit assignments shown below as Modbus I/O data. Set the target selection parameter of that particular data (58.101...58.124) to RO/DIO control word. In the source selection parameter of the desired output, select the appropriate bit of this word.</p>	0000h																					
		<table border="1"> <thead> <tr> <th>Bit</th> <th>Name</th> <th>Description</th> </tr> </thead> <tbody> <tr> <td>0</td> <td>RO1</td> <td rowspan="3">Source bits for relay outputs RO1...RO3 (see parameters 10.24, 10.27 and 10.30).</td> </tr> <tr> <td>1</td> <td>RO2</td> </tr> <tr> <td>2</td> <td>RO3</td> </tr> <tr> <td>3...7</td> <td>Reserved</td> <td></td> </tr> <tr> <td>8</td> <td>DIO1</td> <td rowspan="2">Source bits for digital input/outputs DIO1...DIO3 (see parameters 11.06 and 11.10).</td> </tr> <tr> <td>9</td> <td>DIO2</td> </tr> <tr> <td>10...15</td> <td>Reserved</td> <td></td> </tr> </tbody> </table>	Bit	Name	Description	0	RO1	Source bits for relay outputs RO1...RO3 (see parameters 10.24 , 10.27 and 10.30).	1	RO2	2	RO3	3...7	Reserved		8	DIO1	Source bits for digital input/outputs DIO1...DIO3 (see parameters 11.06 and 11.10).	9	DIO2	10...15	Reserved		
Bit	Name	Description																						
0	RO1	Source bits for relay outputs RO1...RO3 (see parameters 10.24 , 10.27 and 10.30).																						
1	RO2																							
2	RO3																							
3...7	Reserved																							
8	DIO1	Source bits for digital input/outputs DIO1...DIO3 (see parameters 11.06 and 11.10).																						
9	DIO2																							
10...15	Reserved																							
	0000h...FFFFh	RO/DIO control word.	1 = 1																					

No.	Name/Value	Description	Def/FbEq16
11	Standard DIO, FI, FO	Configuration of digital input/outputs and frequency inputs/outputs.	
11.01	DIO status	Displays the status of digital input/outputs DIO2 and DIO1. The activation/deactivation delays (if any are specified) are ignored. A filtering time (for input mode) can be defined by parameter 10.51 DI filter time . Example: 0010 = DIO2 is on, DIO1 is off. This parameter is read-only.	-
	0000b...0011b	Status of digital input/outputs.	1 = 1
11.02	DIO delayed status	Displays the delayed status of digital input/outputs DIO2 and DIO1. This word is updated only after activation/deactivation delays (if any are specified). Example: 0010 = DIO2 is on, DIO1 is off. This parameter is read-only.	-
	0000b...0011b	Delayed status of digital input/outputs.	1 = 1
11.05	DIO1 function	Selects whether DIO1 is used as a digital output or input, or a frequency input.	Output
	Output	DIO1 is used as a digital output.	0
	Input	DIO1 is used as a digital input.	1
	Frequency	DIO1 is used as a frequency input.	2
11.06	DIO1 output source	Selects a drive signal to be connected to digital input/output DIO1 when parameter 11.05 DIO1 function is set to <i>Output</i> .	Ready run
	Not energized	Output is off.	0
	Energized	Output is on.	1
	Ready run	Bit 1 of 06.11 Main status word (see page 108).	2
	Enabled	Bit 0 of 06.16 Drive status word 1 (see page 109).	4
	Started	Bit 5 of 06.16 Drive status word 1 (see page 109).	5
	Magnetized	Bit 1 of 06.17 Drive status word 2 (see page 110).	6
	Running	Bit 6 of 06.16 Drive status word 1 (see page 109).	7
	Ready ref	Bit 2 of 06.11 Main status word (see page 108).	8
	At setpoint	Bit 8 of 06.11 Main status word (see page 108).	9
	Reverse	Bit 2 of 06.19 Speed control status word (see page 112).	10
	Zero speed	Bit 0 of 06.19 Speed control status word (see page 112).	11
	Above limit	Bit 10 of 06.17 Drive status word 2 (see page 110).	12
	Warning	Bit 7 of 06.11 Main status word (see page 108).	13
	Fault	Bit 3 of 06.11 Main status word (see page 108).	14

No.	Name/Value	Description	Def/FbEq16
	Fault (-1)	Inverted bit 3 of 06.11 Main status word (see page 108).	15
	Ext2 active	Bit 11 of 06.16 Drive status word 1 (see page 109).	23
	Remote control	Bit 9 of 06.11 Main status word (see page 108).	24
	Supervision 1	Bit 0 of 32.01 Supervision status (see page 276).	33
	Supervision 2	Bit 1 of 32.01 Supervision status (see page 276).	34
	Supervision 3	Bit 2 of 32.01 Supervision status (see page 276).	35
	RO/DIO control word bit0	Bit 0 of 10.99 RO/DIO control word (see page 129).	40
	RO/DIO control word bit1	Bit 1 of 10.99 RO/DIO control word (see page 129).	41
	RO/DIO control word bit2	Bit 2 of 10.99 RO/DIO control word (see page 129).	42
	RO/DIO control word bit8	Bit 8 of 10.99 RO/DIO control word (see page 129).	43
	RO/DIO control word bit9	Bit 9 of 10.99 RO/DIO control word (see page 129).	44
	Other [bit]	Source selection (see Terms and abbreviations on page 90).	-
11.07	DIO1 ON delay	Defines the activation delay for digital input/output DIO1 (when used as a digital output or digital input).	0.0 s
<p> t_{On} = 11.07 DIO1 ON delay t_{Off} = 11.08 DIO1 OFF delay *Electrical status of DIO (in input mode) or status of selected source (in output mode). Indicated by 11.01 DIO status. **Indicated by 11.02 DIO delayed status. </p>			
	0.0 ... 3000.0 s	Activation delay for DIO1.	10 = 1 s
11.08	DIO1 OFF delay	Defines the deactivation delay for digital input/output DIO1 (when used as a digital output or digital input). See parameter 11.07 DIO1 ON delay .	0.0 s
	0.0 ... 3000.0 s	Deactivation delay for DIO1.	10 = 1 s
11.09	DIO2 function	Selects whether DIO2 is used as a digital output or input, or a frequency output.	Output
	Output	DIO2 is used as a digital output.	0

No.	Name/Value	Description	Def/FbEq16
	Input	DIO2 is used as a digital input.	1
	Frequency	DIO2 is used as a frequency output.	2
11.10	<i>DIO2 output source</i>	Selects a drive signal to be connected to digital input/output DIO2 when parameter 11.09 <i>DIO2 function</i> is set to <i>Output</i> . For the available selections, see parameter 11.06 <i>DIO1 output source</i> .	<i>Running</i>
11.11	<i>DIO2 ON delay</i>	Defines the activation delay for digital input/output DIO2 (when used as a digital output or digital input).	0.0 s
<p><i>t_{On}</i> = 11.11 <i>DIO2 ON delay</i> <i>t_{Off}</i> = 11.12 <i>DIO2 OFF delay</i> *Electrical status of DIO (in input mode) or status of selected source (in output mode). Indicated by 11.01 <i>DIO status</i>. **Indicated by 11.02 <i>DIO delayed status</i>.</p>			
	0.0 ... 3000.0 s	Activation delay for DIO2.	10 = 1 s
11.12	<i>DIO2 OFF delay</i>	Defines the deactivation delay for digital input/output DIO2 (when used as a digital output or digital input). See parameter 11.11 <i>DIO2 ON delay</i> .	0.0 s
	0.0 ... 3000.0 s	Deactivation delay for DIO2.	10 = 1 s
11.38	<i>Freq in 1 actual value</i>	Displays the value of frequency input 1 (via DIO1 when it is used as a frequency input) before scaling. See parameter 11.42 <i>Freq in 1 min</i> . This parameter is read-only.	-
	0 ... 16000 Hz	Unscaled value of frequency input 1.	1 = 1 Hz
11.39	<i>Freq in 1 scaled</i>	Displays the value of frequency input 1 (via DIO1 when it is used as a frequency input) after scaling. See parameter 11.42 <i>Freq in 1 min</i> . This parameter is read-only.	-
	-32768.000 ... 32767.000	Scaled value of frequency input 1.	1 = 1



No.	Name/Value	Description	Def/FbEq16	
11.42	<i>Freq in 1 min</i>	<p>Defines the minimum for the frequency actually arriving at frequency input 1 (DIO1 when it is used as a frequency input).</p> <p>The incoming frequency signal (11.38 <i>Freq in 1 actual value</i>) is scaled into an internal signal (11.39 <i>Freq in 1 scaled</i>) by parameters 11.42...11.45 as follows:</p>	0 Hz	
		0 ... 16000 Hz	Minimum frequency of frequency input 1 (DIO1).	1 = 1 Hz
11.43	<i>Freq in 1 max</i>	<p>Defines the maximum for the frequency actually arriving at frequency input 1 (DIO1 when it is used as a frequency input). See parameter 11.42 <i>Freq in 1 min</i>.</p>	16000 Hz	
		0 ... 16000 Hz	Maximum frequency for frequency input 1 (DIO1).	1 = 1 Hz
11.44	<i>Freq in 1 at scaled min</i>	<p>Defines the value that is required to correspond internally to the minimum input frequency defined by parameter 11.42 <i>Freq in 1 min</i>. See diagram at parameter 11.42 <i>Freq in 1 min</i>.</p>	0.000	
		-32768.000 ... 32767.000	Value corresponding to minimum of frequency input 1.	1 = 1
11.45	<i>Freq in 1 at scaled max</i>	<p>Defines the value that is required to correspond internally to the maximum input frequency defined by parameter 11.43 <i>Freq in 1 max</i>. See diagram at parameter 11.42 <i>Freq in 1 min</i>.</p>	1500.000; 1800.000 (95.20 b0)	
		-32768.000 ... 32767.000	Value corresponding to maximum of frequency input 1.	1 = 1
11.54	<i>Freq out 1 actual value</i>	<p>Displays the value of frequency output 1 after scaling. See parameter 11.58 <i>Freq out 1 src min</i>. This parameter is read-only.</p>	-	
		0 ... 16000 Hz	Value of frequency output 1.	1 = 1

134 Parameters

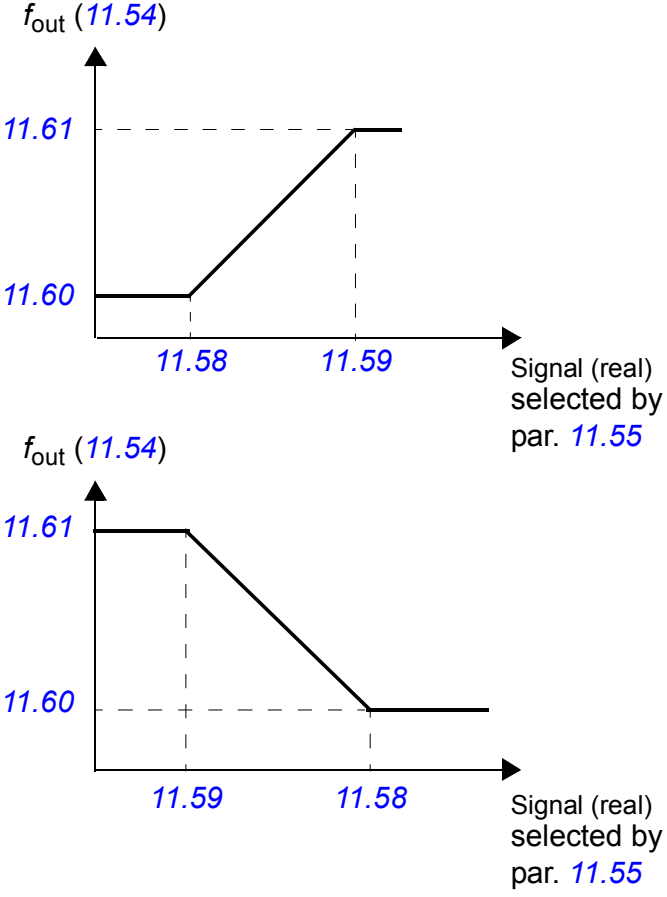
No.	Name/Value	Description	Def/FbEq16
11.55	<i>Freq out 1 source</i>	Selects a signal to be connected to frequency output 1.	<i>Motor speed used</i>
	Zero	None.	0
	Motor speed used	<i>01.01 Motor speed used</i> (page 94).	1
	Output frequency	<i>01.06 Output frequency</i> (page 94).	3
	Motor current	<i>01.07 Motor current</i> (page 94).	4
	Motor torque	<i>01.10 Motor torque</i> (page 95).	6
	DC voltage	<i>01.11 DC voltage</i> (page 95).	7
	Power inu out	<i>01.14 Output power</i> (page 95).	8
	Speed ref ramp in	<i>23.01 Speed ref ramp input</i> (page 209).	10
	Speed ref ramped	<i>23.02 Speed ref ramp output</i> (page 209).	11
	Speed ref used	<i>24.01 Used speed reference</i> (page 217).	12
	Torq ref used	<i>26.02 Torque reference used</i> (page 234).	13
	Freq ref used	<i>28.02 Frequency ref ramp output</i> (page 243).	14
	<i>Other</i>	Source selection (see <i>Terms and abbreviations</i> on page 90).	-

No.	Name/Value	Description	Def/FbEq16
11.58	<i>Freq out 1 src min</i>	Defines the real value of the signal (selected by parameter <i>11.55 Freq out 1 source</i> and shown by parameter <i>11.54 Freq out 1 actual value</i>) that corresponds to the minimum value of frequency output 1 (defined by parameter <i>11.60 Freq out 1 at src min</i>).	0.000
		 <p>The figure contains two graphs. Both graphs have a vertical axis labeled $f_{out} (11.54)$ and a horizontal axis labeled 'Signal (real) selected by par. 11.55'. The top graph shows a piecewise linear function. The horizontal axis has two points marked: 11.58 and 11.59. The vertical axis has two points marked: 11.60 and 11.61. The function is constant at 11.60 for signal values up to 11.58, then increases linearly to 11.61 at signal value 11.59, and remains constant at 11.61 for higher signal values. The bottom graph shows a similar piecewise linear function. The horizontal axis has two points marked: 11.59 and 11.58. The vertical axis has two points marked: 11.61 and 11.60. The function is constant at 11.61 for signal values up to 11.59, then decreases linearly to 11.60 at signal value 11.58, and remains constant at 11.60 for higher signal values.</p>	
-32768.000 ... 32767.000		Real signal value corresponding to minimum value of frequency output 1.	1 = 1
11.59	<i>Freq out 1 src max</i>	Defines the real value of the signal (selected by parameter <i>11.55 Freq out 1 source</i> and shown by parameter <i>11.54 Freq out 1 actual value</i>) that corresponds to the maximum value of frequency output 1 (defined by parameter <i>11.61 Freq out 1 at src max</i>). See parameter <i>11.58 Freq out 1 src min</i> .	1500.000; 1800.000 (95.20 b0)
-32768.000 ... 32767.000		Real signal value corresponding to maximum value of frequency output 1.	1 = 1
11.60	<i>Freq out 1 at src min</i>	Defines the minimum value of frequency output 1. See diagrams at parameter <i>11.58 Freq out 1 src min</i> .	0 Hz
0...16000 Hz		Minimum value of frequency output 1.	1 = 1 Hz

No.	Name/Value	Description	Def/FbEq16
11.61	<i>Freq out 1 at src max</i>	Defines the maximum value of frequency output 1. See diagrams at parameter <i>11.58 Freq out 1 src min</i> .	16000 Hz
	0...16000 Hz	Maximum value of frequency output 1.	1 = 1 Hz
11.81	<i>DIO filter time</i>	Defines a filtering time for parameter <i>11.01 DIO status</i> . The filtering time will only affect the DIOs that are in input mode.	10.0 ms
	0.3 ... 100.0 ms	Filtering time for <i>11.01</i> .	10 = 1 ms
12 Standard AI		Configuration of standard analog inputs.	
12.01	<i>AI tune</i>	Triggers the analog input tuning function. Connect the signal to the input and select the appropriate tuning function.	
	No action	AI tune is not activated.	0
	AI1 min tune	Current analog input AI1 signal value is set as minimum value of AI1 into parameter <i>12.17 AI1 min</i> . The value reverts back to <i>No action</i> automatically.	1
	AI1 max tune	Current analog input AI1 signal value is set as maximum value of AI1 into parameter <i>12.18 AI1 max</i> . The value reverts back to <i>No action</i> automatically.	2
	AI2 min tune	Current analog input AI2 signal value is set as minimum value of AI2 into parameter <i>12.27 AI2 min</i> . The value reverts back to <i>No action</i> automatically.	3
	AI2 max tune	Current analog input AI2 signal value is set as maximum value of AI2 into parameter <i>12.28 AI2 max</i> . The value reverts back to <i>No action</i> automatically.	4
12.03	<i>AI supervision function</i>	Selects how the drive reacts when an analog input signal moves out of the minimum and/or maximum limits specified for the input. The inputs and the limits to be observed are selected by parameter <i>12.04 AI supervision selection</i> .	<i>No action</i>
	No action	No action taken.	0
	Fault	Drive trips on <i>80A0 AI supervision</i> .	1
	Warning	Drive generates an <i>A8A0 AI supervision</i> warning.	2

No.	Name/Value	Description	Def/FbEq16																		
	Last speed	Drive generates a warning (<i>A8A0 AI supervision</i>) and freezes the speed (or frequency) to the level the drive was operating at. The speed/frequency is determined on the basis of actual speed using 850 ms low-pass filtering.  WARNING! Make sure that it is safe to continue operation in case of a communication break.	3																		
	Speed ref safe	Drive generates a warning (<i>A8A0 AI supervision</i>) and sets the speed to the speed defined by parameter <i>22.41 Speed ref safe</i> (or <i>28.41 Frequency ref safe</i> when frequency reference is being used).  WARNING! Make sure that it is safe to continue operation in case of a communication break.	4																		
<i>12.04</i>	<i>AI supervision selection</i>	Specifies the analog input limits to be supervised. See parameter <i>12.03 AI supervision function</i> .	0000b																		
		<table border="1"> <thead> <tr> <th>Bit</th> <th>Name</th> <th>Description</th> </tr> </thead> <tbody> <tr> <td>0</td> <td>AI1 < MIN</td> <td>1 = Minimum limit supervision of AI1 active.</td> </tr> <tr> <td>1</td> <td>AI1 > MAX</td> <td>1 = Maximum limit supervision of AI1 active.</td> </tr> <tr> <td>2</td> <td>AI2 < MIN</td> <td>1 = Minimum limit supervision of AI2 active.</td> </tr> <tr> <td>3</td> <td>AI2 > MAX</td> <td>1 = Maximum limit supervision of AI2 active.</td> </tr> <tr> <td>4...15</td> <td>Reserved</td> <td></td> </tr> </tbody> </table>	Bit	Name	Description	0	AI1 < MIN	1 = Minimum limit supervision of AI1 active.	1	AI1 > MAX	1 = Maximum limit supervision of AI1 active.	2	AI2 < MIN	1 = Minimum limit supervision of AI2 active.	3	AI2 > MAX	1 = Maximum limit supervision of AI2 active.	4...15	Reserved		
Bit	Name	Description																			
0	AI1 < MIN	1 = Minimum limit supervision of AI1 active.																			
1	AI1 > MAX	1 = Maximum limit supervision of AI1 active.																			
2	AI2 < MIN	1 = Minimum limit supervision of AI2 active.																			
3	AI2 > MAX	1 = Maximum limit supervision of AI2 active.																			
4...15	Reserved																				
	0000b...1111b	Activation of analog input supervision.	1 = 1																		
<i>12.11</i>	<i>AI1 actual value</i>	Displays the value of analog input AI1 in mA or V (depending on whether the input is set to current or voltage by a hardware setting). This parameter is read-only.	-																		
	-22.000 ... 22.000 mA or V	Value of analog input AI1.	1000 = 1 mA or V																		
<i>12.12</i>	<i>AI1 scaled value</i>	Displays the value of analog input AI1 after scaling. See parameters <i>12.19 AI1 scaled at AI1 min</i> and <i>12.20 AI1 scaled at AI1 max</i> . This parameter is read-only.	-																		
	-32768.000 ... 32767.000	Scaled value of analog input AI1.	1 = 1																		

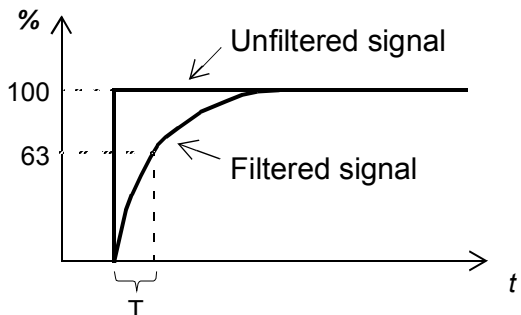
No.	Name/Value	Description	Def/FbEq16
12.15	<i>AI1 unit selection</i>	<p>Selects the unit for readings and settings related to analog input AI1.</p> <p>Note: This setting must match the corresponding hardware setting on the drive control unit (see the hardware manual of the drive). Control board reboot (either by cycling the power or through parameter <i>96.08 Control board boot</i>) is required to validate any changes in the hardware settings.</p>	V
	V	Volts.	2
	mA	Milliamperes.	10
12.16	<i>AI1 filter time</i>	<p>Defines the filter time constant for analog input AI1.</p>  $O = I \times (1 - e^{-t/T})$ <p>I = filter input (step) O = filter output t = time T = filter time constant</p> <p>Note: The signal is also filtered due to the signal interface hardware (approximately 0.25 ms time constant). This cannot be changed by any parameter.</p>	0.100 s
	0.000 ... 30.000 s	Filter time constant.	1000 = 1 s
12.17	<i>AI1 min</i>	<p>Defines the minimum site value for analog input AI1.</p> <p>Set the value actually sent to the drive when the analog signal from plant is wound to its minimum setting.</p> <p>See also parameter <i>12.01 AI tune</i>.</p>	0.000 mA or V
	-22.000 ... 22.000 mA or V	Minimum value of AI1.	1000 = 1 mA or V

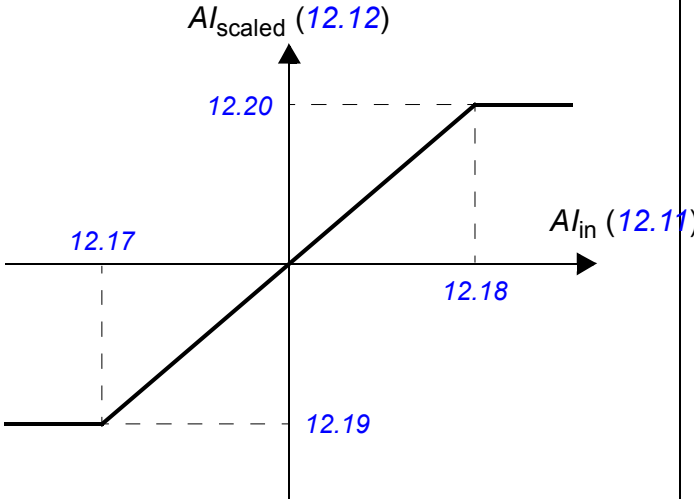
No.	Name/Value	Description	Def/FbEq16
12.18	<i>AI1 max</i>	Defines the maximum site value for analog input AI1. Set the value actually sent to the drive when the analog signal from plant is wound to its maximum setting. See also parameter 12.01 AI tune .	20.000 mA or 10.000 V
	-22.000 ... 22.000 mA or V	Maximum value of AI1.	1000 = 1 mA or V
12.19	<i>AI1 scaled at AI1 min</i>	Defines the real internal value that corresponds to the minimum analog input AI1 value defined by parameter 12.17 AI1 min . (Changing the polarity settings of 12.19 and 12.20 can effectively invert the analog input.)	0.000
			
	-32768.000 ... 32767.000	Real value corresponding to minimum AI1 value.	1 = 1
12.20	<i>AI1 scaled at AI1 max</i>	Defines the real internal value that corresponds to the maximum analog input AI1 value defined by parameter 12.18 AI1 max . See the drawing at parameter 12.19 AI1 scaled at AI1 min .	1500.000; 1800.000 (95.20 b0)
	-32768.000 ... 32767.000	Real value corresponding to maximum AI1 value.	1 = 1
12.21	<i>AI2 actual value</i>	Displays the value of analog input AI2 in mA or V (depending on whether the input is set to current or voltage by a hardware setting). This parameter is read-only.	-
	-22.000 ... 22.000 mA or V	Value of analog input AI2.	1000 = 1 mA or V

140 Parameters

No.	Name/Value	Description	Def/FbEq16
12.22	AI2 scaled value	Displays the value of analog input AI2 after scaling. See parameters 12.29 AI2 scaled at AI2 min and 12.30 AI2 scaled at AI2 max . This parameter is read-only.	-
	-32768.000 ... 32767.000	Scaled value of analog input AI2.	1 = 1
12.25	AI2 unit selection	Selects the unit for readings and settings related to analog input AI2. Note: This setting must match the corresponding hardware setting on the drive control unit (see the hardware manual of the drive). Control board reboot (either by cycling the power or through parameter 96.08 Control board boot) is required to validate any changes in the hardware settings.	<i>mA</i>
	V	Volts.	2
	mA	Milliamperes.	10
12.26	AI2 filter time	Defines the filter time constant for analog input AI2. See parameter 12.16 AI1 filter time .	0.100 s
	0.000 ... 30.000 s	Filter time constant.	1000 = 1 s
12.27	AI2 min	Defines the minimum site value for analog input AI2. Set the value actually sent to the drive when the analog signal from plant is wound to its minimum setting. See also parameter 12.01 AI tune .	0.000 mA or V
	-22.000 ... 22.000 mA or V	Minimum value of AI2.	1000 = 1 mA or V
12.28	AI2 max	Defines the maximum site value for analog input AI2. Set the value actually sent to the drive when the analog signal from plant is wound to its maximum setting. See also parameter 12.01 AI tune .	20.000 mA or 10.000 V
	-22.000 ... 22.000 mA or V	Maximum value of AI2.	1000 = 1 mA or V

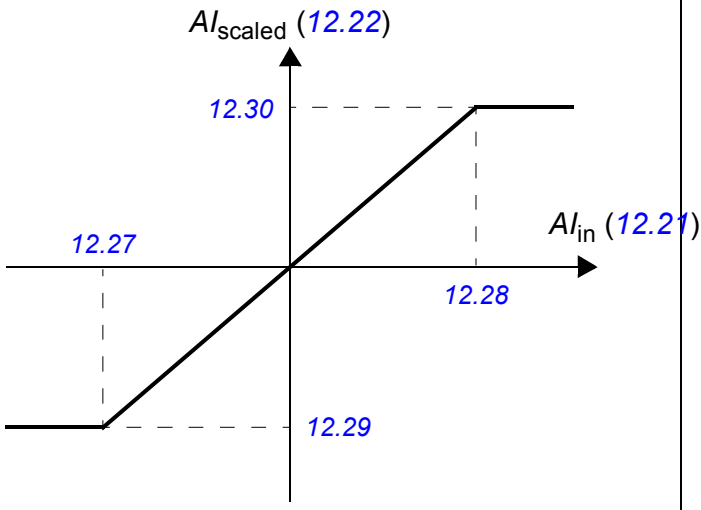
No.	Name/Value	Description	Def/FbEq16
12.29	<i>AI2 scaled at AI2 min</i>	Defines the real value that corresponds to the minimum analog input AI2 value defined by parameter 12.27 AI2 min . (Changing the polarity settings of 12.29 and 12.30 can effectively invert the analog input.) 	0.000
	-32768.000 ... 32767.000	Real value corresponding to minimum AI2 value.	1 = 1
12.30	<i>AI2 scaled at AI2 max</i>	Defines the real value that corresponds to the maximum analog input AI2 value defined by parameter 12.28 AI2 max . See the drawing at parameter 12.29 AI2 scaled at AI2 min .	100.000
	-32768.000 ... 32767.000	Real value corresponding to maximum AI2 value.	1 = 1
13 Standard AO		Configuration of standard analog outputs.	
13.11	<i>AO1 actual value</i>	Displays the value of AO1 in mA. This parameter is read-only.	-
	0.000 ... 22.000 mA	Value of AO1.	1000 = 1 mA
13.12	<i>AO1 source</i>	Selects a signal to be connected to analog output AO1. Alternatively, sets the output to excitation mode to feed a constant current to a temperature sensor.	<i>Motor speed used</i>
	Zero	None.	0
	Motor speed used	01.01 Motor speed used (page 94).	1
	Output frequency	01.06 Output frequency (page 94).	3
	Motor current	01.07 Motor current (page 94).	4
	Motor torque	01.10 Motor torque (page 95).	6
	DC voltage	01.11 DC voltage (page 95).	7
	Power inu out	01.14 Output power (page 95).	8

No.	Name/Value	Description	Def/FbEq16
	Speed ref ramp in	23.01 Speed ref ramp input (page 209).	10
	Speed ref ramp out	23.02 Speed ref ramp output (page 209).	11
	Speed ref used	24.01 Used speed reference (page 217).	12
	Torq ref used	26.02 Torque reference used (page 234).	13
	Freq ref used	28.02 Frequency ref ramp output (page 243).	14
	Force Pt100 excitation	The output is used to feed an excitation current to 1...3 Pt100 sensors. See section Motor thermal protection (page 73).	20
	Force KTY84 excitation	The output is used to feed an excitation current to a KTY84 sensor. See section Motor thermal protection (page 73).	21
	Force PTC excitation	The output is used to feed an excitation current to 1...3 PTC sensors. See section Motor thermal protection (page 73).	22
	Force Pt1000 excitation	The output is used to feed an excitation current to 1...3 Pt1000 sensors. See section Motor thermal protection (page 73).	23
	AO1 data storage	13.91 AO1 data storage (page 147).	37
	AO2 data storage	13.92 AO2 data storage (page 147).	38
	<i>Other</i>	Source selection (see Terms and abbreviations on page 90).	-

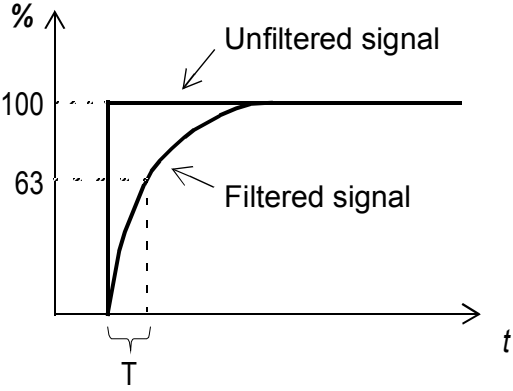
No.	Name/Value	Description	Def/FbEq16
13.16	AO1 filter time	<p>Defines the filtering time constant for analog output AO1.</p>  $O = I \times (1 - e^{-t/T})$ <p> <i>I</i> = filter input (step) <i>O</i> = filter output <i>t</i> = time <i>T</i> = filter time constant </p>	0.100 s
	0.000 ... 30.000 s	Filter time constant.	1000 = 1 s

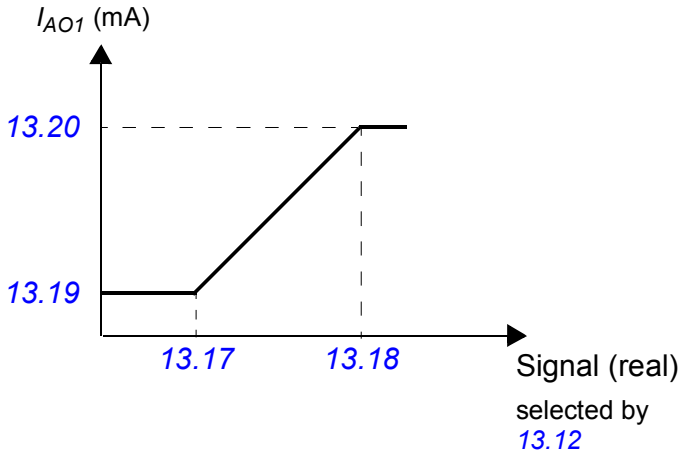
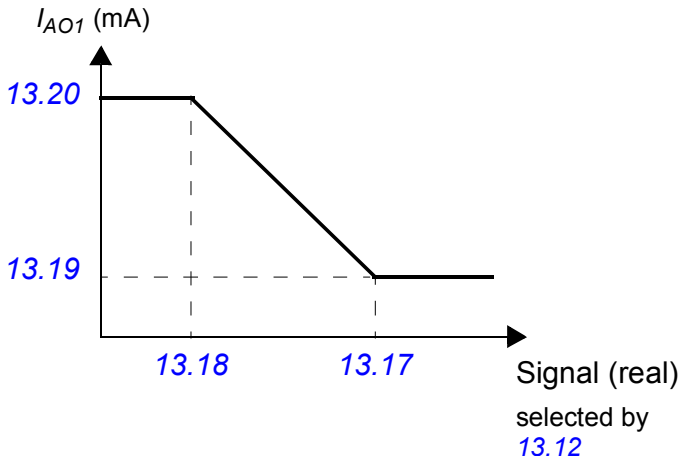
No.	Name/Value	Description	Def/FbEq16
13.17	<i>AO1 source min</i>	<p>Defines the real minimum value of the signal (selected by parameter 13.12 AO1 source) that corresponds to the minimum required AO1 output value (defined by parameter 13.19 AO1 out at AO1 src min).</p>  <p>Programming 13.17 as the maximum value and 13.18 as the minimum value inverts the output.</p> 	0.0
	-32768.0 ... 32767.0	Real signal value corresponding to minimum AO1 output value.	1 = 1
13.18	<i>AO1 source max</i>	<p>Defines the real maximum value of the signal (selected by parameter 13.12 AO1 source) that corresponds to the maximum required AO1 output value (defined by parameter 13.20 AO1 out at AO1 src max). See parameter 13.17 AO1 source min.</p>	1500.0; 1800.0 (95.20 b0)
	-32768.0 ... 32767.0	Real signal value corresponding to maximum AO1 output value.	1 = 1

No.	Name/Value	Description	Def/FbEq16
13.19	AO1 out at AO1 src min	Defines the minimum output value for analog output AO1. See also drawing at parameter 13.17 AO1 source min .	0.000 mA
	0.000 ... 22.000 mA	Minimum AO1 output value.	1000 = 1 mA
13.20	AO1 out at AO1 src max	Defines the maximum output value for analog output AO1. See also drawing at parameter 13.17 AO1 source min .	20.000 mA
	0.000 ... 22.000 mA	Maximum AO1 output value.	1000 = 1 mA
13.21	AO2 actual value	Displays the value of AO2 in mA. This parameter is read-only.	-
	0.000 ... 22.000 mA	Value of AO2.	1000 = 1 mA
13.22	AO2 source	Selects a signal to be connected to analog output AO2. Alternatively, sets the output to excitation mode to feed a constant current to a temperature sensor. For the selections, see parameter 13.12 AO1 source .	Motor current
13.26	AO2 filter time	Defines the filtering time constant for analog output AO2. See parameter 13.16 AO1 filter time .	0.100 s
	0.000 ... 30.000 s	Filter time constant.	1000 = 1 s

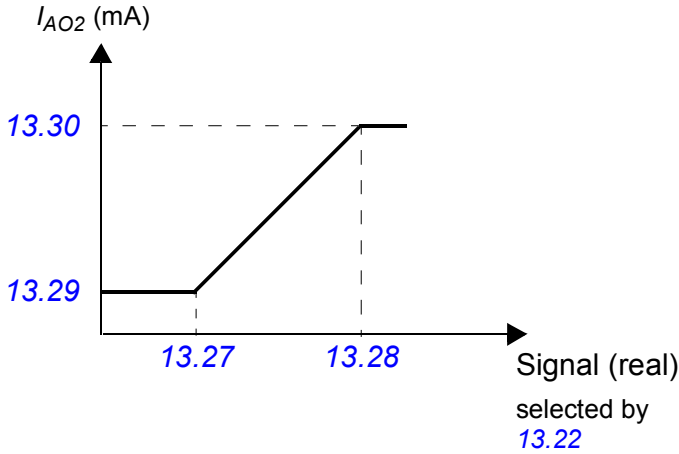
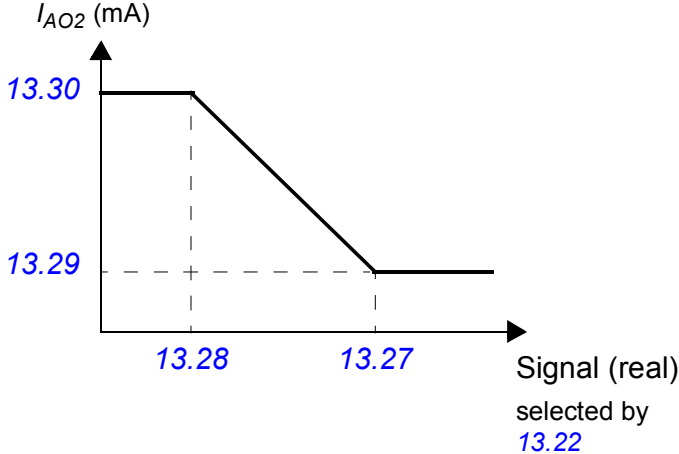
No.	Name/Value	Description	Def/FbEq16
13.27	<i>AO2 source min</i>	<p>Defines the real minimum value of the signal (selected by parameter <i>13.22 AO2 source</i>) that corresponds to the minimum required AO2 output value (defined by parameter <i>13.29 AO2 out at AO2 src min</i>).</p>  <p>Programming <i>13.27</i> as the maximum value and <i>13.28</i> as the minimum value inverts the output.</p> 	0.0
	-32768.0 ... 32767.0	Real signal value corresponding to minimum AO2 output value.	1 = 1
13.28	<i>AO2 source max</i>	<p>Defines the real maximum value of the signal (selected by parameter <i>13.22 AO2 source</i>) that corresponds to the maximum required AO2 output value (defined by parameter <i>13.30 AO2 out at AO2 src max</i>). See parameter <i>13.27 AO2 source min</i>.</p>	100.0
	-32768.0 ... 32767.0	Real signal value corresponding to maximum AO2 output value.	1 = 1



No.	Name/Value	Description	Def/FbEq16
13.29	<i>AO2 out at AO2 src min</i>	Defines the minimum output value for analog output AO2. See also drawing at parameter <i>13.27 AO2 source min</i> .	0.000 mA
	0.000 ... 22.000 mA	Minimum AO2 output value.	1000 = 1 mA
13.30	<i>AO2 out at AO2 src max</i>	Defines the maximum output value for analog output AO2. See also drawing at parameter <i>13.27 AO2 source min</i> .	20.000 mA
	0.000 ... 22.000 mA	Maximum AO2 output value.	1000 = 1 mA
13.91	<i>AO1 data storage</i>	Storage parameter for controlling analog output AO1 eg. through fieldbus. In <i>13.12 AO1 source</i> , select <i>AO1 data storage</i> . Then set this parameter as the target of the incoming value data. With the embedded fieldbus interface, simply set the target selection parameter of that particular data (<i>58.101...58.124</i>) to <i>AO1 data storage</i> .	0.00
	-327.68 ... 327.67	Storage parameter for AO1.	100 = 1
13.92	<i>AO2 data storage</i>	Storage parameter for controlling analog output AO2 eg. through fieldbus. In <i>13.22 AO2 source</i> , select <i>AO2 data storage</i> . Then set this parameter as the target of the incoming value data. With the embedded fieldbus interface, simply set the target selection parameter of that particular data (<i>58.101...58.124</i>) to <i>AO2 data storage</i> .	0.00
	-327.68 ... 327.67	Storage parameter for AO2.	100 = 1
14 I/O extension module 1		Configuration of I/O extension module 1. See also section <i>Programmable I/O extensions</i> (page 37). Note: The contents of the parameter group vary according to the selected I/O extension module type.	
14.01	<i>Module 1 type</i>	Activates (and specifies the type of) I/O extension module 1.	<i>None</i>
	None	Inactive.	0
	FIO-01	FIO-01.	1
	FIO-11	FIO-11.	2

No.	Name/Value	Description	Def/FbEq16
14.02	<i>Module 1 location</i>	Specifies the slot (1...2) on the control unit of the drive into which the I/O extension module is installed.	<i>Slot 1</i>
	Slot 1	Slot 1.	1
	Slot 2	Slot 2.	2
14.03	<i>Module 1 status</i>	Displays the status of I/O extension module 1.	<i>No option</i>
	No option	No module detected in the specified slot.	0
	No communication	A module has been detected but cannot be communicated with.	1
	Unknown	The module type is unknown.	2
	FIO-01	An FIO-01 module has been detected and is active.	15
	FIO-11	An FIO-11 module has been detected and is active.	20
14.05	<i>DIO status</i>	<i>(Visible when 14.01 Module 1 type = FIO-01 or FIO-11)</i> Displays the status of the digital input/outputs on the extension module. The activation/deactivation delays (if any are specified) are ignored. A filtering time (for input mode) can be defined by parameter <i>10.51 DI filter time</i> . Bit 0 indicates the status of DIO1. Note: The number of active bits in this parameter depends on the number of digital input/outputs on the extension module. Example: 1001b = DIO1 and DIO4 are on, remainder are off. This parameter is read-only.	-
	0000b...1111b	Status of digital input/outputs.	1 = 1
14.06	<i>DIO delayed status</i>	<i>(Visible when 14.01 Module 1 type = FIO-01 or FIO-11)</i> Displays the delayed status of the digital input/outputs on the extension module. This word is updated only after activation/deactivation delays (if any are specified). Bit 0 indicates the status of DIO1. Note: The number of active bits in this parameter depends on the number of digital input/outputs on the extension module. Example: 1001b = DIO1 and DIO4 are on, remainder are off. This parameter is read-only.	-
	0000b...1111b	Delayed status of digital input/outputs.	1 = 1

No.	Name/Value	Description	Def/FbEq16
14.08	<i>DIO filter time</i>	(Visible when 14.01 Module 1 type = FIO-01 or FIO-11) Defines a filtering time for parameter 14.05 DIO status. The filtering time will only affect the DIOs that are in input mode.	10.0 ms
	0.8 ... 100.0 ms	Filtering time for 14.05.	10 = 1 ms
14.09	<i>DIO1 function</i>	(Visible when 14.01 Module 1 type = FIO-01 or FIO-11) Selects whether DIO1 of the extension module is used as a digital input or output.	Input
	Output	DIO1 is used as a digital output.	0
	Input	DIO1 is used as a digital input.	1
14.11	<i>DIO1 output source</i>	(Visible when 14.01 Module 1 type = FIO-01 or FIO-11) Selects a drive signal to be connected to digital input/output DIO1 of the extension module when parameter 14.09 DIO1 function is set to Output.	Not energized
	Not energized	Output is not energized.	0
	Energized	Output is energized.	1
	Ready run	Bit 1 of 06.11 Main status word (see page 108).	2
	Enabled	Bit 0 of 06.16 Drive status word 1 (see page 109).	4
	Started	Bit 5 of 06.16 Drive status word 1 (see page 109).	5
	Magnetized	Bit 1 of 06.17 Drive status word 2 (see page 110).	6
	Running	Bit 6 of 06.16 Drive status word 1 (see page 109).	7
	Ready ref	Bit 2 of 06.11 Main status word (see page 108).	8
	At setpoint	Bit 8 of 06.11 Main status word (see page 108).	9
	Reverse	Bit 2 of 06.19 Speed control status word (see page 112).	10
	Zero speed	Bit 0 of 06.19 Speed control status word (see page 112).	11
	Above limit	Bit 10 of 06.17 Drive status word 2 (see page 110).	12
	Warning	Bit 7 of 06.11 Main status word (see page 108).	13
	Fault	Bit 3 of 06.11 Main status word (see page 108).	14
	Fault (-1)	Inverted bit 3 of 06.11 Main status word (see page 108).	15
	Ext2 active	Bit 11 of 06.16 Drive status word 1 (see page 109).	23
	Remote control	Bit 9 of 06.11 Main status word (see page 108).	24
	Supervision 1	Bit 0 of 32.01 Supervision status (see page 276).	33
	Supervision 2	Bit 1 of 32.01 Supervision status (see page 276).	34
	Supervision 3	Bit 2 of 32.01 Supervision status (see page 276).	35

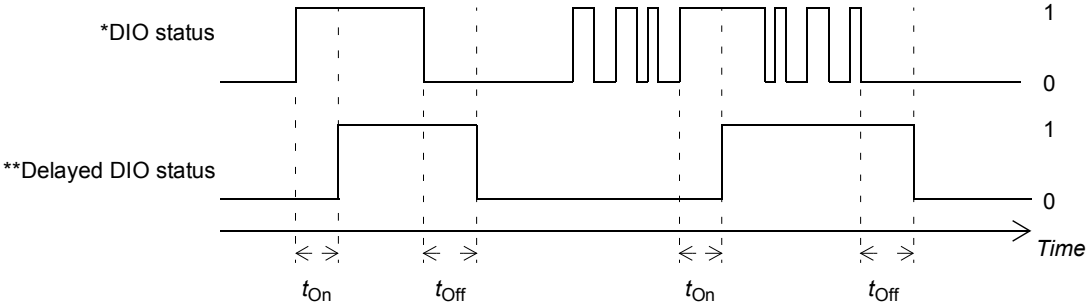
No.	Name/Value	Description	Def/FbEq16
	RO/DIO control word bit0	Bit 0 of 10.99 RO/DIO control word (see page 129).	40
	RO/DIO control word bit1	Bit 1 of 10.99 RO/DIO control word (see page 129).	41
	RO/DIO control word bit2	Bit 2 of 10.99 RO/DIO control word (see page 129).	42
	RO/DIO control word bit8	Bit 8 of 10.99 RO/DIO control word (see page 129).	43
	RO/DIO control word bit9	Bit 9 of 10.99 RO/DIO control word (see page 129).	44
	Other [bit]	Source selection (see Terms and abbreviations on page 90).	-
14.12	DIO1 ON delay	(Visible when 14.01 Module 1 type = FIO-01 or FIO-11) Defines the activation delay for digital input/output DIO1.	0.0 s
<p>t_{On} = 14.12 DIO1 ON delay t_{Off} = 14.13 DIO1 OFF delay *Electrical status of DIO (in input mode) or status of selected source (in output mode). Indicated by 14.05 DIO status. **Indicated by 14.06 DIO delayed status.</p>			
	0.0 ... 3000.0 s	Activation delay for DIO1.	10 = 1 s
14.13	DIO1 OFF delay	(Visible when 14.01 Module 1 type = FIO-01 or FIO-11) Defines the deactivation delay for digital input/output DIO1. See parameter 14.12 DIO1 ON delay .	0.0 s
	0.0 ... 3000.0 s	Deactivation delay for DIO1.	10 = 1 s
14.14	DIO2 function	(Visible when 14.01 Module 1 type = FIO-01 or FIO-11) Selects whether DIO2 of the extension module is used as a digital input or output.	Input
	Output	DIO2 is used as a digital output.	0
	Input	DIO2 is used as a digital input.	1

No.	Name/Value	Description	Def/FbEq16
14.16	DIO2 output source	(Visible when 14.01 Module 1 type = FIO-01 or FIO-11) Selects a drive signal to be connected to digital input/output DIO2 when parameter 14.14 DIO2 function is set to Output. For the available selections, see parameter 14.11 DIO1 output source.	Not energized
14.17	DIO2 ON delay	(Visible when 14.01 Module 1 type = FIO-01 or FIO-11) Defines the activation delay for digital input/output DIO2.	0.0 s
 <p>t_{On} = 14.17 DIO2 ON delay t_{Off} = 14.18 DIO2 OFF delay *Electrical status of DIO (in input mode) or status of selected source (in output mode). Indicated by 14.05 DIO status. **Indicated by 14.06 DIO delayed status.</p>			
	0.0 ... 3000.0 s	Activation delay for DIO2.	10 = 1 s
14.18	DIO2 OFF delay	(Visible when 14.01 Module 1 type = FIO-01 or FIO-11) Defines the deactivation delay for digital input/output DIO2. See parameter 14.17 DIO2 ON delay.	0.0 s
	0.0 ... 3000.0 s	Deactivation delay for DIO2.	10 = 1 s
14.19	DIO3 function	(Visible when 14.01 Module 1 type = FIO-01) Selects whether DIO3 of the extension module is used as a digital input or output.	Input
	Output	DIO3 is used as a digital output.	0
	Input	DIO3 is used as a digital input.	1
14.19	AI supervision function	(Visible when 14.01 Module 1 type = FIO-11) Selects how the drive reacts when an analog input signal moves out of the minimum and/or maximum limits specified for the input. The inputs and the limits to be observed are selected by parameter 14.20 AI supervision selection.	No action
	No action	No action taken.	0

No.	Name/Value	Description	Def/FbEq16																								
	Fault	Drive trips on <i>80A0 AI supervision</i> .	1																								
	Warning	Drive generates an <i>A8A0 AI supervision</i> warning.	2																								
	Last speed	Drive generates a warning (<i>A8A0 AI supervision</i>) and freezes the speed (or frequency) to the level the drive was operating at. The speed/frequency is determined on the basis of actual speed using 850 ms low-pass filtering.  WARNING! Make sure that it is safe to continue operation in case of a communication break.	3																								
	Speed ref safe	Drive generates a warning (<i>A8A0 AI supervision</i>) and sets the speed to the speed defined by parameter <i>22.41 Speed ref safe</i> (or <i>28.41 Frequency ref safe</i> when frequency reference is being used).  WARNING! Make sure that it is safe to continue operation in case of a communication break.	4																								
<i>14.20</i>	<i>AI supervision selection</i>	(Visible when <i>14.01 Module 1 type = FIO-11</i>) Specifies the analog input limits to be supervised. See parameter <i>14.19 AI supervision function</i> . Note: The number of active bits in this parameter depends on the number of inputs on the extension module.	0000 0000b																								
		<table border="1"> <thead> <tr> <th>Bit</th> <th>Name</th> <th>Description</th> </tr> </thead> <tbody> <tr> <td>0</td> <td>AI1 < MIN</td> <td>1 = Minimum limit supervision of AI1 active.</td> </tr> <tr> <td>1</td> <td>AI1 > MAX</td> <td>1 = Maximum limit supervision of AI1 active.</td> </tr> <tr> <td>2</td> <td>AI2 < MIN</td> <td>1 = Minimum limit supervision of AI2 active.</td> </tr> <tr> <td>3</td> <td>AI2 > MAX</td> <td>1 = Maximum limit supervision of AI2 active.</td> </tr> <tr> <td>4</td> <td>AI3 < MIN</td> <td>1 = Minimum limit supervision of AI3 active (FIO-11 only).</td> </tr> <tr> <td>5</td> <td>AI3 > MAX</td> <td>1 = Maximum limit supervision of AI3 active (FIO-11 only).</td> </tr> <tr> <td>6...15</td> <td>Reserved</td> <td></td> </tr> </tbody> </table>	Bit	Name	Description	0	AI1 < MIN	1 = Minimum limit supervision of AI1 active.	1	AI1 > MAX	1 = Maximum limit supervision of AI1 active.	2	AI2 < MIN	1 = Minimum limit supervision of AI2 active.	3	AI2 > MAX	1 = Maximum limit supervision of AI2 active.	4	AI3 < MIN	1 = Minimum limit supervision of AI3 active (FIO-11 only).	5	AI3 > MAX	1 = Maximum limit supervision of AI3 active (FIO-11 only).	6...15	Reserved		
Bit	Name	Description																									
0	AI1 < MIN	1 = Minimum limit supervision of AI1 active.																									
1	AI1 > MAX	1 = Maximum limit supervision of AI1 active.																									
2	AI2 < MIN	1 = Minimum limit supervision of AI2 active.																									
3	AI2 > MAX	1 = Maximum limit supervision of AI2 active.																									
4	AI3 < MIN	1 = Minimum limit supervision of AI3 active (FIO-11 only).																									
5	AI3 > MAX	1 = Maximum limit supervision of AI3 active (FIO-11 only).																									
6...15	Reserved																										
	0000 0000b ... 0011 1111b	Activation of analog input supervision.	1 = 1																								
<i>14.21</i>	<i>DIO3 output source</i>	(Visible when <i>14.01 Module 1 type = FIO-01</i>) Selects a drive signal to be connected to digital input/output DIO3 when parameter <i>14.19 DIO3 function</i> is set to <i>Output</i> . For the available selections, see parameter <i>14.11 DIO1 output source</i> .	<i>Not energized</i>																								

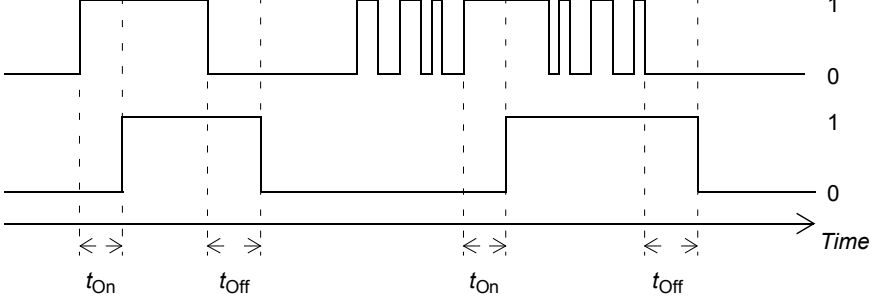
No.	Name/Value	Description	Def/FbEq16
14.21	<i>AI tune</i>	<p>(Visible when <i>14.01 Module 1 type = FIO-11</i>)</p> <p>Triggers the analog input tuning function, which enables the use of actual measurements as the minimum and maximum input values instead of potentially inaccurate estimates.</p> <p>Apply the minimum or maximum signal to the input and select the appropriate tuning function.</p> <p>See also the drawing at parameter <i>14.35 AI1 scaled at AI1 min</i>.</p>	<i>No action</i>
	No action	<p>Tuning action completed or no action has been requested.</p> <p>The parameter automatically reverts to this value after any tuning action.</p>	0
	AI1 min tune	The measured value of AI1 is set as the minimum value of AI1 into parameter <i>14.33 AI1 min</i> .	1
	AI1 max tune	The measured value of AI1 is set as the maximum value of AI1 into parameter <i>14.34 AI1 max</i> .	2
	AI2 min tune	The measured value of AI2 is set as the minimum value of AI2 into parameter <i>14.48 AI2 min</i> .	3
	AI2 max tune	The measured value of AI2 is set as the maximum value of AI2 into parameter <i>14.49 AI2 max</i> .	4
	AI3 min tune	<p>(Visible when <i>14.01 Module 1 type = FIO-11</i>)</p> <p>The measured value of AI3 is set as the minimum value of AI3 into parameter <i>14.63 AI3 min</i>.</p>	5
	AI3 max tune	<p>(Visible when <i>14.01 Module 1 type = FIO-11</i>)</p> <p>The measured value of AI3 is set as the maximum value of AI3 into parameter <i>14.64 AI3 max</i>.</p>	6
14.22	<i>DIO3 ON delay</i>	<p>(Visible when <i>14.01 Module 1 type = FIO-01</i>)</p> <p>Defines the activation delay for digital input/output DIO3.</p>	0.0 s
 <p>$t_{On} = 14.22$ <i>DIO3 ON delay</i> $t_{Off} = 14.23$ <i>DIO3 OFF delay</i></p> <p>*Electrical status of DIO (in input mode) or status of selected source (in output mode). Indicated by <i>14.05 DIO status</i>.</p> <p>**Indicated by <i>14.06 DIO delayed status</i>.</p>			
0.0 ... 3000.0 s	Activation delay for DIO3.	10 = 1 s	

No.	Name/Value	Description	Def/FbEq16															
14.22	<i>AI force selection</i>	(Visible when <i>14.01 Module 1 type = FIO-11</i>) The true readings of the analog inputs can be overridden for eg. testing purposes. A forced value parameter is provided for each analog input, and its value is applied whenever the corresponding bit in this parameter is 1.	0000b															
<table border="1"> <thead> <tr> <th>Bit</th> <th>Name</th> <th>Description</th> </tr> </thead> <tbody> <tr> <td>0</td> <td>AI1</td> <td>1 = Force mode: Force AI1 to value of parameter <i>14.28 AI1 force data</i>.</td> </tr> <tr> <td>1</td> <td>AI2</td> <td>1 = Force mode: Force AI2 to value of parameter <i>14.43 AI2 force data</i>.</td> </tr> <tr> <td>2</td> <td>AI3</td> <td>1 = Force mode: Force AI3 to value of parameter <i>14.58 AI3 force data</i> (FIO-11 only).</td> </tr> <tr> <td>3...15</td> <td>Reserved</td> <td></td> </tr> </tbody> </table>				Bit	Name	Description	0	AI1	1 = Force mode: Force AI1 to value of parameter <i>14.28 AI1 force data</i> .	1	AI2	1 = Force mode: Force AI2 to value of parameter <i>14.43 AI2 force data</i> .	2	AI3	1 = Force mode: Force AI3 to value of parameter <i>14.58 AI3 force data</i> (FIO-11 only).	3...15	Reserved	
Bit	Name	Description																
0	AI1	1 = Force mode: Force AI1 to value of parameter <i>14.28 AI1 force data</i> .																
1	AI2	1 = Force mode: Force AI2 to value of parameter <i>14.43 AI2 force data</i> .																
2	AI3	1 = Force mode: Force AI3 to value of parameter <i>14.58 AI3 force data</i> (FIO-11 only).																
3...15	Reserved																	
	0000b...0111b	Forced values selector for analog inputs.	1 = 1															
14.23	<i>DIO3 OFF delay</i>	(Visible when <i>14.01 Module 1 type = FIO-01</i>) Defines the deactivation delay for digital input/output DIO3. See parameter <i>14.22 DIO3 ON delay</i> .	0.0 s															
	0.0 ... 3000.0 s	Deactivation delay for DIO3.	10 = 1 s															
14.24	<i>DIO4 function</i>	(Visible when <i>14.01 Module 1 type = FIO-01</i>) Selects whether DIO4 of the extension module is used as a digital input or output.	<i>Input</i>															
	Output	DIO4 is used as a digital output.	0															
	Input	DIO4 is used as a digital input.	1															
14.26	<i>DIO4 output source</i>	(Visible when <i>14.01 Module 1 type = FIO-01</i>) Selects a drive signal to be connected to digital input/output DIO4 when parameter <i>14.24 DIO4 function</i> is set to <i>Output</i> . For the available selections, see parameter <i>14.11 DIO1 output source</i> .	<i>Not energized</i>															
14.26	<i>AI1 actual value</i>	(Visible when <i>14.01 Module 1 type = FIO-11</i>) Displays the value of analog input AI1 in mA or V (depending on whether the input is set to current or voltage). This parameter is read-only.	-															
	-22.000 ... 22.000 mA or V	Value of analog input AI1.	1000 = 1 mA or V															

No.	Name/Value	Description	Def/FbEq16
14.27	<i>DIO4 ON delay</i>	(Visible when 14.01 Module 1 type = FIO-01) Defines the activation delay for digital input/output DIO4.	0.0 s
<p>$t_{On} = 14.27$ DIO4 ON delay $t_{Off} = 14.28$ DIO4 OFF delay *Electrical status of DIO (in input mode) or status of selected source (in output mode). Indicated by 14.05 DIO status. **Indicated by 14.06 DIO delayed status.</p>			
	0.0 ... 3000.0 s	Activation delay for DIO4.	10 = 1 s
14.27	<i>AI1 scaled value</i>	(Visible when 14.01 Module 1 type = FIO-11) Displays the value of analog input AI1 after scaling. See parameter 14.35 AI1 scaled at AI1 min. This parameter is read-only.	-
	-32768.000 ... 32767.000	Scaled value of analog input AI1.	1 = 1
14.28	<i>DIO4 OFF delay</i>	(Visible when 14.01 Module 1 type = FIO-01) Defines the deactivation delay for digital input/output DIO4. See parameter 14.27 DIO4 ON delay.	0.0 s
	0.0 ... 3000.0 s	Deactivation delay for DIO4.	10 = 1 s
14.28	<i>AI1 force data</i>	(Visible when 14.01 Module 1 type = FIO-11) Forced value that can be used instead of the true reading of the input. See parameter 14.22 AI force selection.	0.000 mA
	-22.000 ... 22.000 mA or V	Forced value of analog input AI1.	1000 = 1 mA or V
14.29	<i>AI1 HW switch position</i>	(Visible when 14.01 Module 1 type = FIO-11) Shows the position of the hardware current/voltage selector on the I/O extension module. Note: The setting of the current/voltage selector must match the unit selection made in parameter 14.30 AI1 unit selection. I/O module reboot either by cycling the power or through parameter 96.08 Control board boot is required to validate any changes in the hardware settings.	-
	V	Volts.	2

No.	Name/Value	Description	Def/FbEq16
	mA	Milliamperes.	10
14.30	<i>AI1 unit selection</i>	(Visible when 14.01 Module 1 type = FIO-11) Selects the unit for readings and settings related to analog input AI1. Note: This setting must match the corresponding hardware setting on the I/O extension module (see the manual of the I/O extension module). The hardware setting is shown by parameter 14.29 AI1 HW switch position. I/O module reboot either by cycling the power or through parameter 96.08 Control board boot is required to validate any changes in the hardware settings.	mA
	V	Volts.	2
	mA	Milliamperes.	10
14.31	<i>RO status</i>	(Visible when 14.01 Module 1 type = FIO-01) Status of relay outputs on the I/O extension module. Example: 0001b = RO1 is energized, RO2 is de-energized.	-
	0000b...1111b	Status of relay outputs.	1 = 1
14.31	<i>AI1 filter gain</i>	(Visible when 14.01 Module 1 type = FIO-11) Selects a hardware filtering time for AI1. See also parameter 14.32 AI1 filter time.	1 ms
	No filtering	No filtering.	0
	125 us	125 microseconds.	1
	250 us	250 microseconds.	2
	500 us	500 microseconds.	3
	1 ms	1 millisecond.	4
	2 ms	2 milliseconds.	5
	4 ms	4 milliseconds.	6
	7.9375 ms	7.9375 milliseconds.	7

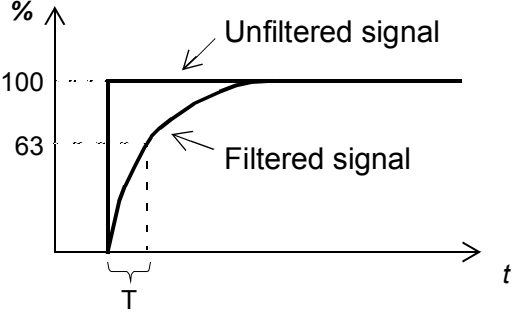
No.	Name/Value	Description	Def/FbEq16
14.32	<i>AI1 filter time</i>	<p>(Visible when <i>14.01 Module 1 type = FIO-11</i>)</p> <p>Defines the filter time constant for analog input AI1.</p>  $O = I \times (1 - e^{-t/T})$ <p>I = filter input (step) O = filter output t = time T = filter time constant</p> <p>Note: The signal is also filtered due to the signal interface hardware. See parameter <i>14.31 AI1 filter gain</i>.</p>	0.100 s
	0.000 ... 30.000 s	Filter time constant.	1000 = 1 s
14.33	<i>AI1 min</i>	<p>(Visible when <i>14.01 Module 1 type = FIO-11</i>)</p> <p>Defines the minimum value for analog input AI1. See also parameter <i>14.21 AI tune</i>.</p>	0.000 mA or V
	-22.000 ... 22.000 mA or V	Minimum value of AI1.	1000 = 1 mA or V
14.34	<i>RO1 source</i>	<p>(Visible when <i>14.01 Module 1 type = FIO-01</i>)</p> <p>Selects a drive signal to be connected to relay output RO1. For the available selections, see parameter <i>14.11 DIO1 output source</i>.</p>	<i>Not energized</i>
14.34	<i>AI1 max</i>	<p>(Visible when <i>14.01 Module 1 type = FIO-11</i>)</p> <p>Defines the maximum value for analog input AI1. See also parameter <i>14.21 AI tune</i>.</p>	10.000 mA or V
	-22.000 ... 22.000 mA or V	Maximum value of AI1.	1000 = 1 mA or V

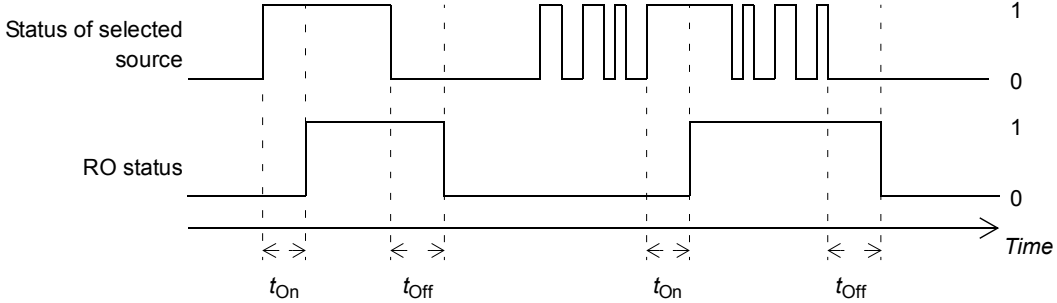
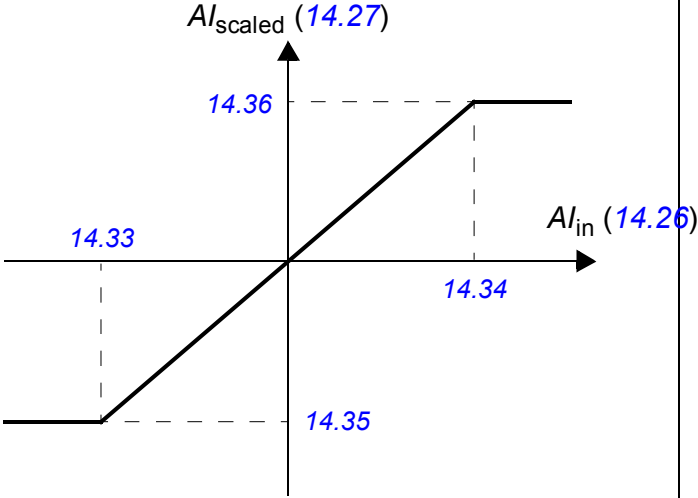
No.	Name/Value	Description	Def/FbEq16
14.35	<i>RO1 ON delay</i>	<p>(Visible when 14.01 Module 1 type = FIO-01)</p> <p>Defines the activation delay for relay output RO1.</p>  <p>$t_{On} = 14.35$ RO1 ON delay $t_{Off} = 14.36$ RO1 OFF delay</p>	0.0 s
	0.0 ... 3000.0 s	Activation delay for RO1.	10 = 1 s
14.35	<i>AI1 scaled at AI1 min</i>	<p>(Visible when 14.01 Module 1 type = FIO-11)</p> <p>Defines the real value that corresponds to the minimum analog input AI1 value defined by parameter 14.33 AI1 min.</p> 	0.000
	-32768.000 ... 32767.000	Real value corresponding to minimum AI1 value.	1 = 1
14.36	<i>RO1 OFF delay</i>	<p>(Visible when 14.01 Module 1 type = FIO-01)</p> <p>Defines the deactivation delay for relay output RO1. See parameter 14.35 RO1 ON delay.</p>	0.0 s
	0.0 ... 3000.0 s	Deactivation delay for RO1.	10 = 1 s
14.36	<i>AI1 scaled at AI1 max</i>	<p>(Visible when 14.01 Module 1 type = FIO-11)</p> <p>Defines the real value that corresponds to the maximum analog input AI1 value defined by parameter 14.34 AI1 max. See the drawing at parameter 14.35 AI1 scaled at AI1 min.</p>	100.000
	-32768.000 ... 32767.000	Real value corresponding to maximum AI1 value.	1 = 1

No.	Name/Value	Description	Def/FbEq16
14.37	RO2 source	(Visible when 14.01 Module 1 type = FIO-01) Selects a drive signal to be connected to relay output RO2. For the available selections, see parameter 14.11 DIO1 output source.	Not energized
14.38	RO2 ON delay	(Visible when 14.01 Module 1 type = FIO-01) Defines the activation delay for relay output RO2.	0.0 s
<p>$t_{On} = 14.38$ RO2 ON delay $t_{Off} = 14.39$ RO2 OFF delay</p>			
	0.0 ... 3000.0 s	Activation delay for RO2.	10 = 1 s
14.39	RO2 OFF delay	(Visible when 14.01 Module 1 type = FIO-01) Defines the deactivation delay for relay output RO2. See parameter 14.38 RO2 ON delay.	0.0 s
	0.0 ... 3000.0 s	Deactivation delay for RO2.	10 = 1 s
14.41	AI2 actual value	(Visible when 14.01 Module 1 type = FIO-11) Displays the value of analog input AI2 in mA or V (depending on whether the input is set to current or voltage). This parameter is read-only.	-
	-22.000 ... 22.000 mA or V	Value of analog input AI2.	1000 = 1 mA or V
14.42	AI2 scaled value	(Visible when 14.01 Module 1 type = FIO-11) Displays the value of analog input AI2 after scaling. See parameter 14.50 AI2 scaled at AI2 min. This parameter is read-only.	-
	-32768.000 ... 32767.000	Scaled value of analog input AI2.	1 = 1
14.43	AI2 force data	(Visible when 14.01 Module 1 type = FIO-11) Forced value that can be used instead of the true reading of the input. See parameter 14.22 AI force selection.	0.000 mA
	-22.000 ... 22.000 mA or V	Forced value of analog input AI2.	1000 = 1 mA or V

No.	Name/Value	Description	Def/FbEq16
14.44	<i>AI2 HW switch position</i>	(Visible when <i>14.01 Module 1 type = FIO-11</i>) Shows the position of the hardware current/voltage selector on the I/O extension module. Note: The setting of the current/voltage selector must match the unit selection made in parameter <i>14.45 AI2 unit selection</i> . I/O module reboot either by cycling the power or through parameter <i>96.08 Control board boot</i> is required to validate any changes in the hardware settings.	-
	V	Volts.	2
	mA	Milliamperes.	10
14.45	<i>AI2 unit selection</i>	(Visible when <i>14.01 Module 1 type = FIO-11</i>) Selects the unit for readings and settings related to analog input AI2. Note: This setting must match the corresponding hardware setting on the I/O extension module (see the manual of the I/O extension module). The hardware setting is shown by parameter <i>14.44 AI2 HW switch position</i> . I/O module reboot either by cycling the power or through parameter <i>96.08 Control board boot</i> is required to validate any changes in the hardware settings.	<i>mA</i>
	V	Volts.	2
	mA	Milliamperes.	10
14.46	<i>AI2 filter gain</i>	(Visible when <i>14.01 Module 1 type = FIO-11</i>) Selects a hardware filtering time for AI2. See also parameter <i>14.47 AI2 filter time</i> .	<i>1 ms</i>
	No filtering	No filtering.	0
	125 us	125 microseconds.	1
	250 us	250 microseconds.	2
	500 us	500 microseconds.	3
	1 ms	1 millisecond.	4
	2 ms	2 milliseconds.	5
	4 ms	4 milliseconds.	6
	7.9375 ms	7.9375 milliseconds.	7

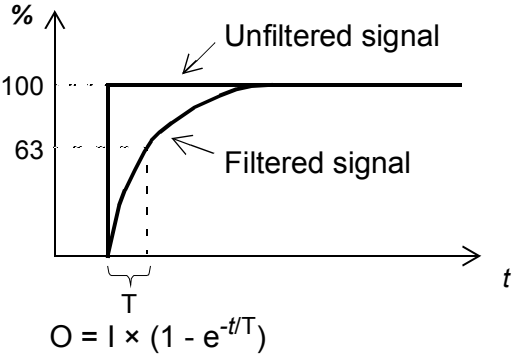
No.	Name/Value	Description	Def/FbEq16
14.47	AI2 filter time	<p>(Visible when 14.01 Module 1 type = FIO-11)</p> <p>Defines the filter time constant for analog input AI2.</p>  <p>$O = I \times (1 - e^{-t/T})$</p> <p>I = filter input (step) O = filter output t = time T = filter time constant</p> <p>Note: The signal is also filtered due to the signal interface hardware. See parameter 14.46 AI2 filter gain.</p>	0.100 s
	0.000 ... 30.000 s	Filter time constant.	1000 = 1 s
14.48	AI2 min	<p>(Visible when 14.01 Module 1 type = FIO-11)</p> <p>Defines the minimum value for analog input AI2. See also parameter 14.21 AI tune.</p>	0.000 mA or V
	-22.000 ... 22.000 mA or V	Minimum value of AI2.	1000 = 1 mA or V
14.49	AI2 max	<p>(Visible when 14.01 Module 1 type = FIO-11)</p> <p>Defines the maximum value for analog input AI2. See also parameter 14.21 AI tune.</p>	10.000 mA or V
	-22.000 ... 22.000 mA or V	Maximum value of AI2.	1000 = 1 mA or V

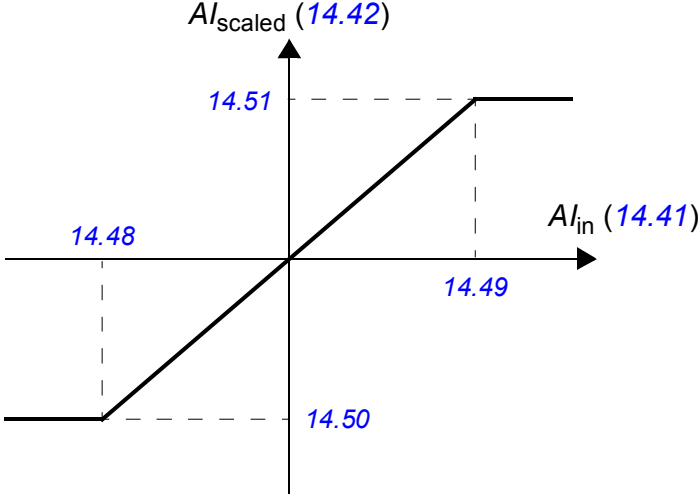
No.	Name/Value	Description	Def/FbEq16
14.50	AI2 scaled at AI2 min	<p>(Visible when 14.01 Module 1 type = FIO-11)</p> <p>Defines the real value that corresponds to the minimum analog input AI2 value defined by parameter 14.48 AI2 min.</p> 	0.000
-32768.000 ... 32767.000	Real value corresponding to minimum AI2 value.	1 = 1	
14.51	AI2 scaled at AI2 max	<p>(Visible when 14.01 Module 1 type = FIO-11)</p> <p>Defines the real value that corresponds to the maximum analog input AI2 value defined by parameter 14.49 AI2 max. See the drawing at parameter 14.50 AI2 scaled at AI2 min.</p>	100.000
-32768.000 ... 32767.000	Real value corresponding to maximum AI2 value.	1 = 1	
14.56	AI3 actual value	<p>(Visible when 14.01 Module 1 type = FIO-11)</p> <p>Displays the value of analog input AI3 in mA or V (depending on whether the input is set to current or voltage).</p> <p>This parameter is read-only.</p>	-
-22.000 ... 22.000 mA or V	Value of analog input AI3.	1000 = 1 mA or V	
14.57	AI3 scaled value	<p>(Visible when 14.01 Module 1 type = FIO-11)</p> <p>Displays the value of analog input AI3 after scaling. See parameter 14.65 AI3 scaled at AI3 min.</p> <p>This parameter is read-only.</p>	-
-32768.000 ... 32767.000	Scaled value of analog input AI3.	1 = 1	

No.	Name/Value	Description	Def/FbEq16
14.58	<i>AI3 force data</i>	(Visible when <i>14.01 Module 1 type = FIO-11</i>) Forced value that can be used instead of the true reading of the input. See parameter <i>14.22 AI force selection</i> .	0.000 mA
	-22.000 ... 22.000 mA or V	Forced value of analog input AI3.	1000 = 1 mA or V
14.59	<i>AI3 HW switch position</i>	(Visible when <i>14.01 Module 1 type = FIO-11</i>) Shows the position of the hardware current/voltage selector on the I/O extension module. Note: The setting of the current/voltage selector must match the unit selection made in parameter <i>14.60 AI3 unit selection</i> . I/O module reboot either by cycling the power or through parameter <i>96.08 Control board boot</i> is required to validate any changes in the hardware settings.	-
	V	Volts.	2
	mA	Milliamperes.	10
14.60	<i>AI3 unit selection</i>	(Visible when <i>14.01 Module 1 type = FIO-11</i>) Selects the unit for readings and settings related to analog input AI3. Note: This setting must match the corresponding hardware setting on the I/O extension module (see the manual of the I/O extension module). The hardware setting is shown by parameter <i>14.59 AI3 HW switch position</i> . I/O module reboot either by cycling the power or through parameter <i>96.08 Control board boot</i> is required to validate any changes in the hardware settings.	<i>mA</i>
	V	Volts.	2
	mA	Milliamperes.	10
14.61	<i>AI3 filter gain</i>	(Visible when <i>14.01 Module 1 type = FIO-11</i>) Selects a hardware filtering time for AI3. See also parameter <i>14.62 AI3 filter time</i> .	<i>1 ms</i>
	No filtering	No filtering.	0
	125 us	125 microseconds.	1
	250 us	250 microseconds.	2
	500 us	500 microseconds.	3
	1 ms	1 millisecond.	4
	2 ms	2 milliseconds.	5
	4 ms	4 milliseconds.	6
	7.9375 ms	7.9375 milliseconds.	7

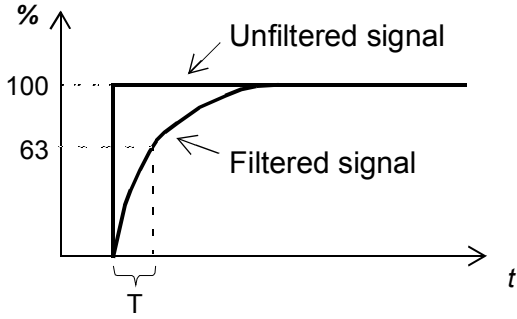
No.	Name/Value	Description	Def/FbEq16
14.62	AI3 filter time	<p>(Visible when 14.01 Module 1 type = FIO-11)</p> <p>Defines the filter time constant for analog input AI3.</p>  $O = I \times (1 - e^{-t/T})$ <p>I = filter input (step) O = filter output t = time T = filter time constant</p> <p>Note: The signal is also filtered due to the signal interface hardware. See parameter 14.61 AI3 filter gain.</p>	0.100 s
	0.000 ... 30.000 s	Filter time constant.	1000 = 1 s
14.63	AI3 min	<p>(Visible when 14.01 Module 1 type = FIO-11)</p> <p>Defines the minimum value for analog input AI3. See also parameter 14.21 AI tune.</p>	0.000 mA or V
	-22.000 ... 22.000 mA or V	Minimum value of AI3.	1000 = 1 mA or V
14.64	AI3 max	<p>(Visible when 14.01 Module 1 type = FIO-11)</p> <p>Defines the maximum value for analog input AI3. See also parameter 14.21 AI tune.</p>	10.000 mA or V
	-22.000 ... 22.000 mA or V	Maximum value of AI3.	1000 = 1 mA or V

No.	Name/Value	Description	Def/FbEq16									
14.65	<i>AI3 scaled at AI3 min</i>	<p>(Visible when 14.01 Module 1 type = FIO-11)</p> <p>Defines the real value that corresponds to the minimum analog input AI3 value defined by parameter 14.63 AI3 min.</p>	0.000									
	-32768.000 ... 32767.000	Real value corresponding to minimum AI3 value.	1 = 1									
14.66	<i>AI3 scaled at AI3 max</i>	<p>(Visible when 14.01 Module 1 type = FIO-11)</p> <p>Defines the real value that corresponds to the maximum analog input AI3 value defined by parameter 14.64 AI3 max. See the drawing at parameter 14.65 AI3 scaled at AI3 min.</p>	100.000									
	-32768.000 ... 32767.000	Real value corresponding to maximum AI3 value.	1 = 1									
14.71	<i>AO force selection</i>	<p>(Visible when 14.01 Module 1 type = FIO-11)</p> <p>The value of the analog output can be overridden for eg. testing purposes. A forced value parameter (14.78 AO1 force data) is provided for the analog output, and its value is applied whenever the corresponding bit in this parameter is 1.</p>	0000b									
		<table border="1"> <thead> <tr> <th>Bit</th> <th>Name</th> <th>Description</th> </tr> </thead> <tbody> <tr> <td>0</td> <td>AO1</td> <td>1 = Force mode: Force AO1 to value of parameter 14.78 AO1 force data.</td> </tr> <tr> <td>1...15</td> <td>Reserved</td> <td></td> </tr> </tbody> </table>	Bit	Name	Description	0	AO1	1 = Force mode: Force AO1 to value of parameter 14.78 AO1 force data.	1...15	Reserved		
Bit	Name	Description										
0	AO1	1 = Force mode: Force AO1 to value of parameter 14.78 AO1 force data.										
1...15	Reserved											
	0000b...0001b	Forced values selector for analog outputs.	1 = 1									
14.76	<i>AO1 actual value</i>	<p>(Visible when 14.01 Module 1 type = FIO-11)</p> <p>Displays the value of AO1 in mA. This parameter is read-only.</p>	-									
	0.000 ... 22.000 mA	Value of AO1.	1000 = 1 mA									

No.	Name/Value	Description	Def/FbEq16
14.77	AO1 source	(Visible when 14.01 Module 1 type = FIO-11) Selects a signal to be connected to analog output AO1. Alternatively, sets the output to excitation mode to feed a constant current to a temperature sensor.	Zero
	Zero	None.	0
	Motor speed used	01.01 Motor speed used (page 94).	1
	Output frequency	01.06 Output frequency (page 94).	3
	Motor current	01.07 Motor current (page 94).	4
	Motor torque	01.10 Motor torque (page 95).	6
	DC voltage	01.11 DC voltage (page 95).	7
	Power inu out	01.14 Output power (page 95).	8
	Speed ref ramp in	23.01 Speed ref ramp input (page 209).	10
	Speed ref ramp out	23.02 Speed ref ramp output (page 209).	11
	Speed ref used	24.01 Used speed reference (page 217).	12
	Torq ref used	26.02 Torque reference used (page 234).	13
	Freq ref used	28.02 Frequency ref ramp output (page 243).	14
	Force Pt100 excitation	The output is used to feed an excitation current to 1...3 Pt100 sensors. See section <i>Motor thermal protection</i> (page 73).	20
	Force KTY84 excitation	The output is used to feed an excitation current to a KTY84 sensor. See section <i>Motor thermal protection</i> (page 73).	21
	Force PTC excitation	The output is used to feed an excitation current to 1...3 PTC sensors. See section <i>Motor thermal protection</i> (page 73).	22
	Force Pt1000 excitation	The output is used to feed an excitation current to 1...3 Pt1000 sensors. See section <i>Motor thermal protection</i> (page 73).	23
	AO1 data storage	13.91 AO1 data storage (page 147).	37
	AO2 data storage	13.92 AO2 data storage (page 147).	38
	Other	Source selection (see <i>Terms and abbreviations</i> on page 90).	-

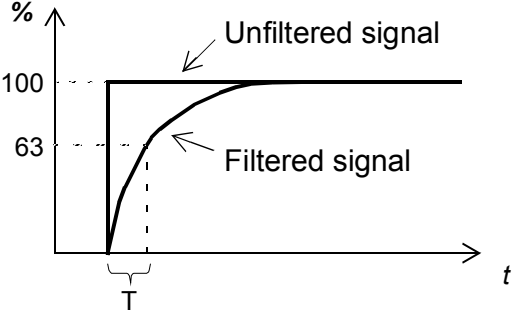
No.	Name/Value	Description	Def/FbEq16
14.78	AO1 force data	(Visible when 14.01 Module 1 type = FIO-11) Forced value that can be used instead of the selected output signal. See parameter 14.71 AO force selection.	0.000 mA
	0.000 ... 22.000 mA	Forced value of analog output AO1.	1000 = 1 mA
14.79	AO1 filter time	(Visible when 14.01 Module 1 type = FIO-11) Defines the filtering time constant for analog output AO1.  $O = I \times (1 - e^{-t/T})$ I = filter input (step) O = filter output t = time T = filter time constant	0.100 s
	0.000 ... 30.000 s	Filter time constant.	1000 = 1 s

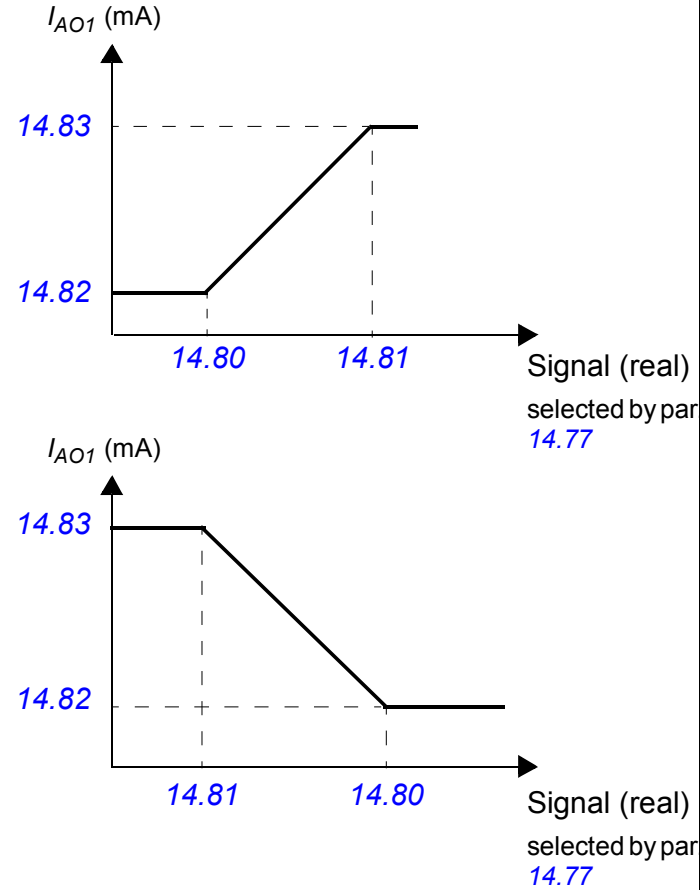
No.	Name/Value	Description	Def/FbEq16
14.80	AO1 source min	<p>(Visible when 14.01 Module 1 type = FIO-11)</p> <p>Defines the real value of the signal (selected by parameter 14.77 AO1 source) that corresponds to the minimum AO1 output value (defined by parameter 14.82 AO1 out at AO1 src min).</p> 	0.0
-32768.0 ... 32767.0	Real signal value corresponding to minimum AO1 output value.	1 = 1	
14.81	AO1 source max	<p>(Visible when 14.01 Module 1 type = FIO-11)</p> <p>Defines the real value of the signal (selected by parameter 14.77 AO1 source) that corresponds to the maximum AO1 output value (defined by parameter 14.83 AO1 out at AO1 src max). See parameter 14.80 AO1 source min.</p>	100.0
-32768.0 ... 32767.0	Real signal value corresponding to maximum AO1 output value.	1 = 1	
14.82	AO1 out at AO1 src min	<p>(Visible when 14.01 Module 1 type = FIO-11)</p> <p>Defines the minimum output value for analog output AO1.</p> <p>See also drawing at parameter 14.80 AO1 source min.</p>	0.000 mA
0.000 ... 22.000 mA	Minimum AO1 output value.	1000 = 1 mA	

No.	Name/Value	Description	Def/FbEq16
14.83	AO1 out at AO1 src max	(Visible when 14.01 Module 1 type = FIO-11) Defines the maximum output value for analog output AO1. See also drawing at parameter 14.80 AO1 source min.	10.000 mA
	0.000 ... 22.000 mA	Maximum AO1 output value.	1000 = 1 mA
	0.000 ... 30.000 s	Filter time constant.	1000 = 1 s
	-32768.0 ... 32767.0	Real signal value corresponding to minimum AO2 output value.	1 = 1
15 I/O extension module 2			
		Configuration of I/O extension module 2. See also section <i>Programmable I/O extensions</i> (page 37). Note: The contents of the parameter group vary according to the selected I/O extension module type.	
15.01	Module 2 type	See parameter 14.01 Module 1 type.	None
15.02	Module 2 location	See parameter 14.02 Module 1 location.	Slot 1
15.03	Module 2 status	See parameter 14.03 Module 1 status.	No option
15.05	DIO status	(Visible when 15.01 Module 2 type = FIO-01 or FIO-11) See parameter 14.05 DIO status.	-
15.06	DIO delayed status	(Visible when 15.01 Module 2 type = FIO-01 or FIO-11) See parameter 14.06 DIO delayed status.	-
15.08	DIO filter time	(Visible when 15.01 Module 2 type = FIO-01 or FIO-11) See parameter 14.08 DIO filter time.	10.0 ms
15.09	DIO1 function	(Visible when 15.01 Module 2 type = FIO-01 or FIO-11) See parameter 14.09 DIO1 function.	Input
15.11	DIO1 output source	(Visible when 15.01 Module 2 type = FIO-01 or FIO-11) See parameter 14.11 DIO1 output source.	Not energized
15.12	DIO1 ON delay	(Visible when 15.01 Module 2 type = FIO-01 or FIO-11) See parameter 14.12 DIO1 ON delay.	0.0 s
15.13	DIO1 OFF delay	(Visible when 15.01 Module 2 type = FIO-01 or FIO-11) See parameter 14.13 DIO1 OFF delay.	0.0 s

170 Parameters

No.	Name/Value	Description	Def/FbEq16
15.14	DIO2 function	(Visible when 15.01 Module 2 type = FIO-01 or FIO-11) See parameter 14.14 DIO2 function.	Input
15.16	DIO2 output source	(Visible when 15.01 Module 2 type = FIO-01 or FIO-11) See parameter 14.16 DIO2 output source.	Not energized
15.17	DIO2 ON delay	(Visible when 15.01 Module 2 type = FIO-01 or FIO-11) See parameter 14.17 DIO2 ON delay.	0.0 s
15.18	DIO2 OFF delay	(Visible when 15.01 Module 2 type = FIO-01 or FIO-11) See parameter 14.18 DIO2 OFF delay.	0.0 s
15.19	DIO3 function	(Visible when 15.01 Module 2 type = FIO-01) See parameter 14.19 DIO3 function.	Input
15.19	AI supervision function	(Visible when 15.01 Module 2 type = FIO-11) See parameter 14.19 AI supervision function.	No action
15.20	AI supervision selection	(Visible when 15.01 Module 2 type = FIO-11) See parameter 14.20 AI supervision selection.	0000 0000b
15.21	DIO3 output source	(Visible when 15.01 Module 2 type = FIO-01) See parameter 14.21 DIO3 output source.	Not energized
15.21	AI tune	(Visible when 15.01 Module 2 type = FIO-11) See parameter 14.21 AI tune.	No action
15.22	DIO3 ON delay	(Visible when 15.01 Module 2 type = FIO-01) See parameter 14.22 DIO3 ON delay.	0.0 s
15.22	AI force selection	(Visible when 15.01 Module 2 type = FIO-11) See parameter 14.22 AI force selection.	0000b
15.23	DIO3 OFF delay	(Visible when 15.01 Module 2 type = FIO-01) See parameter 14.23 DIO3 OFF delay.	0.0 s
15.24	DIO4 function	(Visible when 15.01 Module 2 type = FIO-01) See parameter 14.24 DIO4 function.	Input
15.26	DIO4 output source	(Visible when 15.01 Module 2 type = FIO-01) See parameter 14.26 DIO4 output source.	Not energized
15.26	AI1 actual value	(Visible when 15.01 Module 2 type = FIO-11) See parameter 14.26 AI1 actual value.	-
15.27	DIO4 ON delay	(Visible when 15.01 Module 2 type = FIO-01) See parameter 14.27 DIO4 ON delay.	0.0 s
15.27	AI1 scaled value	(Visible when 15.01 Module 2 type = FIO-11) See parameter 14.27 AI1 scaled value.	-
15.28	DIO4 OFF delay	(Visible when 15.01 Module 2 type = FIO-01) See parameter 14.28 DIO4 OFF delay.	0.0 s

No.	Name/Value	Description	Def/FbEq16
15.28	AI1 force data	(Visible when 15.01 Module 2 type = FIO-11) See parameter 14.28 AI1 force data.	0.000 mA
15.29	AI1 HW switch position	(Visible when 15.01 Module 2 type = FIO-11) See parameter 14.29 AI1 HW switch position.	-
15.30	AI1 unit selection	(Visible when 15.01 Module 2 type = FIO-11) See parameter 14.30 AI1 unit selection.	mA
15.31	RO status	(Visible when 15.01 Module 2 type = FIO-01) See parameter 14.31 RO status.	-
15.31	AI1 filter gain	(Visible when 15.01 Module 2 type = FIO-11) See parameter 14.31 AI1 filter gain.	1 ms
15.32	AI1 filter time	(Visible when 15.01 Module 2 type = FIO-11) See parameter 14.32 AI1 filter time.	0.100 s
15.33	AI1 min	(Visible when 15.01 Module 2 type = FIO-11) See parameter 14.33 AI1 min.	0.000 mA or V
15.34	RO1 source	(Visible when 15.01 Module 2 type = FIO-01) See parameter 14.34 RO1 source.	Not energized
15.34	AI1 max	(Visible when 15.01 Module 2 type = FIO-11) See parameter 14.34 AI1 max.	10.000 mA or V
15.35	RO1 ON delay	(Visible when 15.01 Module 2 type = FIO-01) See parameter 14.35 RO1 ON delay.	0.0 s
15.35	AI1 scaled at AI1 min	(Visible when 15.01 Module 2 type = FIO-11) See parameter 14.35 AI1 scaled at AI1 min.	0.000
15.36	RO1 OFF delay	(Visible when 15.01 Module 2 type = FIO-01) See parameter 14.36 RO1 OFF delay.	0.0 s
15.36	AI1 scaled at AI1 max	(Visible when 15.01 Module 2 type = FIO-11) See parameter 14.36 AI1 scaled at AI1 max.	100.000
15.37	RO2 source	(Visible when 15.01 Module 2 type = FIO-01) See parameter 14.37 RO2 source.	Not energized
15.38	RO2 ON delay	(Visible when 15.01 Module 2 type = FIO-01) See parameter 14.38 RO2 ON delay.	0.0 s
15.39	RO2 OFF delay	(Visible when 15.01 Module 2 type = FIO-01) See parameter 14.39 RO2 OFF delay.	0.0 s
15.41	AI2 actual value	(Visible when 15.01 Module 2 type = FIO-11) See parameter 14.41 AI2 actual value.	-
15.42	AI2 scaled value	(Visible when 15.01 Module 2 type = FIO-11) See parameter 14.42 AI2 scaled value.	-
15.43	AI2 force data	(Visible when 15.01 Module 2 type = FIO-11) See parameter 14.43 AI2 force data.	0.000 mA

172 Parameters

No.	Name/Value	Description	Def/FbEq16
15.44	AI2 HW switch position	(Visible when 15.01 Module 2 type = FIO-11) See parameter 14.44 AI2 HW switch position .	-
15.45	AI2 unit selection	(Visible when 15.01 Module 2 type = FIO-11) See parameter 14.45 AI2 unit selection .	mA
15.46	AI2 filter gain	(Visible when 15.01 Module 2 type = FIO-11) See parameter 14.46 AI2 filter gain .	1 ms
15.47	AI2 filter time	(Visible when 15.01 Module 2 type = FIO-11) See parameter 14.47 AI2 filter time .	0.100 s
15.48	AI2 min	(Visible when 15.01 Module 2 type = FIO-11) See parameter 14.48 AI2 min .	0.000 mA or V
15.49	AI2 max	(Visible when 15.01 Module 2 type = FIO-11) See parameter 14.49 AI2 max .	10.000 mA or V
15.50	AI2 scaled at AI2 min	(Visible when 15.01 Module 2 type = FIO-11) See parameter 14.50 AI2 scaled at AI2 min .	0.000
15.51	AI2 scaled at AI2 max	(Visible when 15.01 Module 2 type = FIO-11) See parameter 14.51 AI2 scaled at AI2 max .	100.000
15.56	AI3 actual value	(Visible when 15.01 Module 2 type = FIO-11) See parameter 14.56 AI3 actual value .	-
15.57	AI3 scaled value	(Visible when 15.01 Module 2 type = FIO-11) See parameter 14.57 AI3 scaled value .	-
15.58	AI3 force data	(Visible when 15.01 Module 2 type = FIO-11) See parameter 14.58 AI3 force data .	0.000 mA
15.59	AI3 HW switch position	(Visible when 15.01 Module 2 type = FIO-11) See parameter 14.59 AI3 HW switch position .	-
15.60	AI3 unit selection	(Visible when 15.01 Module 2 type = FIO-11) See parameter 14.60 AI3 unit selection .	mA
15.61	AI3 filter gain	(Visible when 15.01 Module 2 type = FIO-11) See parameter 14.61 AI3 filter gain .	1 ms
15.62	AI3 filter time	(Visible when 15.01 Module 2 type = FIO-11) See parameter 14.62 AI3 filter time .	0.100 s
15.63	AI3 min	(Visible when 15.01 Module 2 type = FIO-11) See parameter 14.63 AI3 min .	0.000 mA or V
15.64	AI3 max	(Visible when 15.01 Module 2 type = FIO-11) See parameter 14.64 AI3 max .	10.000 mA or V
15.65	AI3 scaled at AI3 min	(Visible when 15.01 Module 2 type = FIO-11) See parameter 14.65 AI3 scaled at AI3 min .	0.000
15.66	AI3 scaled at AI3 max	(Visible when 15.01 Module 2 type = FIO-11) See parameter 14.66 AI3 scaled at AI3 max .	100.000

No.	Name/Value	Description	Def/FbEq16
15.71	AO force selection	(Visible when 15.01 Module 2 type = FIO-11) See parameter 14.71 AO force selection.	00b
15.76	AO1 actual value	(Visible when 15.01 Module 2 type = FIO-11) See parameter 14.76 AO1 actual value.	-
15.77	AO1 source	(Visible when 15.01 Module 2 type = FIO-11) See parameter 14.77 AO1 source.	Zero
15.78	AO1 force data	(Visible when 15.01 Module 2 type = FIO-11) See parameter 14.78 AO1 force data.	0.000 mA
15.79	AO1 filter time	(Visible when 15.01 Module 2 type = FIO-11) See parameter 14.79 AO1 filter time.	0.100 s
15.80	AO1 source min	(Visible when 15.01 Module 2 type = FIO-11) See parameter 14.80 AO1 source min.	0.0
15.81	AO1 source max	(Visible when 15.01 Module 2 type = FIO-11) See parameter 14.81 AO1 source max.	100.0
15.82	AO1 out at AO1 src min	(Visible when 15.01 Module 2 type = FIO-11) See parameter 14.82 AO1 out at AO1 src min.	0.000 mA
15.83	AO1 out at AO1 src max	(Visible when 15.01 Module 2 type = FIO-11) See parameter 14.83 AO1 out at AO1 src max.	10.000 mA

19 Operation mode	Selection of local and external control location sources and operating modes. See also section <i>Operating modes of the drive</i> (page 28).		
19.01 Actual operation mode	Displays the operating mode currently used. See parameters 19.11...19.14. This parameter is read-only.		-
Zero	None.		1
Speed	Speed control (in DTC motor control mode).		2
Torque	Torque control (in DTC motor control mode).		3
Min	The torque selector is comparing the output of the speed controller (25.01 Torque reference speed control) and torque reference (26.74 Torque ref ramp out) and the smaller of the two is used.		4
Max	The torque selector is comparing the output of the speed controller (25.01 Torque reference speed control) and torque reference (26.74 Torque ref ramp out) and the greater of the two is used.		5
Add	The speed controller output is added to the torque reference.		6
Scalar (Hz)	Frequency control in scalar motor control mode.		10
Scalar (rpm)	Speed control in scalar motor control mode.		11
Forced magn.	Motor is in magnetizing mode.		20

No.	Name/Value	Description	Def/FbEq16
19.11	<i>Ext1/Ext2 selection</i>	Selects the source for external control location EXT1/EXT2 selection. 0 = EXT1 1 = EXT2	<i>EXT1</i>
	EXT1	EXT1 (permanently selected).	0
	EXT2	EXT2 (permanently selected).	1
	FBA A MCW bit 11	Control word bit 11 received through fieldbus interface A.	2
	DI1	Digital input DI1 (<i>10.02 DI delayed status</i> , bit 0).	3
	DI2	Digital input DI2 (<i>10.02 DI delayed status</i> , bit 1).	4
	DI3	Digital input DI3 (<i>10.02 DI delayed status</i> , bit 2).	5
	DI4	Digital input DI4 (<i>10.02 DI delayed status</i> , bit 3).	6
	DI5	Digital input DI5 (<i>10.02 DI delayed status</i> , bit 4).	7
	DI6	Digital input DI6 (<i>10.02 DI delayed status</i> , bit 5).	8
	DIO1	Digital input/output DIO1 (<i>11.02 DIO delayed status</i> , bit 0).	11
	DIO2	Digital input/output DIO2 (<i>11.02 DIO delayed status</i> , bit 1).	12
	EFB MCW bit 11	Control word bit 11 received through the embedded fieldbus interface.	32
	<i>Other [bit]</i>	Source selection (see <i>Terms and abbreviations</i> on page 90).	-
19.12	<i>Ext1 control mode</i>	Selects the operating mode for external control location EXT1.	<i>Speed</i>
	Zero	None.	1
	Speed	Speed control. The torque reference used is <i>25.01 Torque reference speed control</i> (output of the speed reference chain).	2
	Torque	Torque control. The torque reference used is <i>26.74 Torque ref ramp out</i> (output of the torque reference chain).	3
	Minimum	Combination of selections <i>Speed</i> and <i>Torque</i> : the torque selector compares the speed controller output (<i>25.01 Torque reference speed control</i>) and the torque reference (<i>26.74 Torque ref ramp out</i>) and selects the smaller of the two. If speed error becomes negative, the drive follows the speed controller output until speed error becomes positive again. This prevents the drive from accelerating uncontrollably if the load is lost in torque control.	4

No.	Name/Value	Description	Def/FbEq16
	Maximum	<p>Combination of selections <i>Speed</i> and <i>Torque</i>: the torque selector compares the speed controller output (<i>25.01 Torque reference speed control</i>) and the torque reference (<i>26.74 Torque ref ramp out</i>) and selects the greater of the two.</p> <p>If speed error becomes positive, the drive follows the speed controller output until speed error becomes negative again. This prevents the drive from accelerating uncontrollably if the load is lost in torque control.</p>	5
	Add	<p>Combination of selections <i>Speed</i> and <i>Torque</i>: Torque selector adds the speed reference chain output to the torque reference chain output.</p>	6
19.14	<i>Ext2 control mode</i>	<p>Selects the operating mode for external control location EXT2.</p> <p>For the selections, see parameter <i>19.12 Ext1 control mode</i>.</p>	<i>Speed</i>
19.16	<i>Local control mode</i>	<p>Selects the operating mode for local control.</p>	<i>Speed</i>
	Speed	<p>Speed control. The torque reference used is <i>25.01 Torque reference speed control</i> (output of the speed reference chain).</p>	0
	Torque	<p>Torque control. The torque reference used is <i>26.74 Torque ref ramp out</i> (output of the torque reference chain).</p>	1
19.17	<i>Local control disable</i>	<p>Enables/disables local control (start and stop buttons on the control panel, and the local controls on the PC tool).</p> <p> WARNING! Before disabling local control, ensure that the control panel is not needed for stopping the drive.</p>	<i>No</i>
	No	<p>Local control enabled.</p>	0
	Yes	<p>Local control disabled.</p>	1
19.20	<i>Scalar control reference unit</i>	<p>Selects the reference type for scalar motor control mode.</p> <p>See also section <i>Operating modes of the drive</i> (page 28), and parameter <i>99.04 Motor control mode</i>.</p>	<i>Rpm</i>
	Hz	<p>Hz. The reference is taken from parameter <i>28.02 Frequency ref ramp output</i> (output of the frequency control chain).</p>	0
	Rpm	<p>Rpm. The reference is taken from parameter <i>23.02 Speed ref ramp output</i> (speed reference after ramping and shaping).</p>	1

No.	Name/Value	Description	Def/FbEq16														
20	Start/stop/direction	Start/stop/direction and run/start/jog enable signal source selection; positive/negative reference enable signal source selection. For information on control locations, see section Local control vs. external control (page 26).															
20.01	<i>Ext1 commands</i>	Selects the source of start, stop and direction commands for external control location 1 (EXT1). See also parameters 20.02...20.05 .	<i>In1 Start; In2 Dir</i>														
	Not selected	No start or stop command sources selected.	0														
	In1 Start	The source of the start and stop commands is selected by parameter 20.03 Ext1 in1 source . The state transitions of the source bits are interpreted as follows: <table border="1" data-bbox="545 801 1089 974"> <thead> <tr> <th>State of source 1 (20.03)</th> <th>Command</th> </tr> </thead> <tbody> <tr> <td>0 -> 1 (20.02 = Edge)</td> <td>Start</td> </tr> <tr> <td>1 (20.02 = Level)</td> <td></td> </tr> <tr> <td>0</td> <td>Stop</td> </tr> </tbody> </table>	State of source 1 (20.03)	Command	0 -> 1 (20.02 = Edge)	Start	1 (20.02 = Level)		0	Stop	1						
State of source 1 (20.03)	Command																
0 -> 1 (20.02 = Edge)	Start																
1 (20.02 = Level)																	
0	Stop																
	In1 Start; In2 Dir	The source selected by 20.03 Ext1 in1 source is the start signal; the source selected by 20.04 Ext1 in2 source determines the direction. The state transitions of the source bits are interpreted as follows: <table border="1" data-bbox="489 1220 1172 1496"> <thead> <tr> <th>State of source 1 (20.03)</th> <th>State of source 2 (20.04)</th> <th>Command</th> </tr> </thead> <tbody> <tr> <td>0</td> <td>Any</td> <td>Stop</td> </tr> <tr> <td rowspan="2">0 -> 1 (20.02 = Edge)</td> <td>0</td> <td>Start forward</td> </tr> <tr> <td>1</td> <td>Start reverse</td> </tr> <tr> <td>1 (20.02 = Level)</td> <td></td> <td></td> </tr> </tbody> </table>	State of source 1 (20.03)	State of source 2 (20.04)	Command	0	Any	Stop	0 -> 1 (20.02 = Edge)	0	Start forward	1	Start reverse	1 (20.02 = Level)			2
State of source 1 (20.03)	State of source 2 (20.04)	Command															
0	Any	Stop															
0 -> 1 (20.02 = Edge)	0	Start forward															
	1	Start reverse															
1 (20.02 = Level)																	

No.	Name/Value	Description	Def/FbEq16																
	In1 Start fwd; In2 Start rev	<p>The source selected by 20.03 Ext1 in1 source is the forward start signal; the source selected by 20.04 Ext1 in2 source is the reverse start signal. The state transitions of the source bits are interpreted as follows:</p> <table border="1" data-bbox="561 454 1251 869"> <thead> <tr> <th data-bbox="569 454 827 533">State of source 1 (20.03)</th> <th data-bbox="835 454 1094 533">State of source 2 (20.04)</th> <th data-bbox="1102 454 1251 533">Command</th> </tr> </thead> <tbody> <tr> <td data-bbox="569 533 827 577">0</td> <td data-bbox="835 533 1094 577">0</td> <td data-bbox="1102 533 1251 577">Stop</td> </tr> <tr> <td data-bbox="569 577 827 701">0 -> 1 (20.02 = Edge) 1 (20.02 = Level)</td> <td data-bbox="835 577 1094 701">0</td> <td data-bbox="1102 577 1251 701">Start forward</td> </tr> <tr> <td data-bbox="569 701 827 824">0</td> <td data-bbox="835 701 1094 824">0 -> 1 (20.02 = Edge) 1 (20.02 = Level)</td> <td data-bbox="1102 701 1251 824">Start reverse</td> </tr> <tr> <td data-bbox="569 824 827 869">1</td> <td data-bbox="835 824 1094 869">1</td> <td data-bbox="1102 824 1251 869">Stop</td> </tr> </tbody> </table>	State of source 1 (20.03)	State of source 2 (20.04)	Command	0	0	Stop	0 -> 1 (20.02 = Edge) 1 (20.02 = Level)	0	Start forward	0	0 -> 1 (20.02 = Edge) 1 (20.02 = Level)	Start reverse	1	1	Stop	3	
State of source 1 (20.03)	State of source 2 (20.04)	Command																	
0	0	Stop																	
0 -> 1 (20.02 = Edge) 1 (20.02 = Level)	0	Start forward																	
0	0 -> 1 (20.02 = Edge) 1 (20.02 = Level)	Start reverse																	
1	1	Stop																	
	In1P Start; In2 Stop	<p>The sources of the start and stop commands are selected by parameters 20.03 Ext1 in1 source and 20.04 Ext1 in2 source. The state transitions of the source bits are interpreted as follows:</p> <table border="1" data-bbox="561 1081 1251 1245"> <thead> <tr> <th data-bbox="569 1081 827 1160">State of source 1 (20.03)</th> <th data-bbox="835 1081 1094 1160">State of source 2 (20.04)</th> <th data-bbox="1102 1081 1251 1160">Command</th> </tr> </thead> <tbody> <tr> <td data-bbox="569 1160 827 1205">0 -> 1</td> <td data-bbox="835 1160 1094 1205">1</td> <td data-bbox="1102 1160 1251 1205">Start</td> </tr> <tr> <td data-bbox="569 1205 827 1245">Any</td> <td data-bbox="835 1205 1094 1245">0</td> <td data-bbox="1102 1205 1251 1245">Stop</td> </tr> </tbody> </table> <p>Note: The start signal is always edge-triggered with this setting regardless of parameter 20.02 Ext1 start trigger type.</p>	State of source 1 (20.03)	State of source 2 (20.04)	Command	0 -> 1	1	Start	Any	0	Stop	4							
State of source 1 (20.03)	State of source 2 (20.04)	Command																	
0 -> 1	1	Start																	
Any	0	Stop																	
	In1P Start; In2 Stop; In3 Dir	<p>The sources of the start and stop commands are selected by parameters 20.03 Ext1 in1 source and 20.04 Ext1 in2 source. The source selected by 20.05 Ext1 in3 source determines the direction. The state transitions of the source bits are interpreted as follows:</p> <table border="1" data-bbox="561 1648 1251 1888"> <thead> <tr> <th data-bbox="569 1648 725 1760">State of source 1 (20.03)</th> <th data-bbox="733 1648 890 1760">State of source 2 (20.04)</th> <th data-bbox="898 1648 1055 1760">State of source 3 (20.05)</th> <th data-bbox="1063 1648 1251 1760">Command</th> </tr> </thead> <tbody> <tr> <td data-bbox="569 1760 725 1805">0 -> 1</td> <td data-bbox="733 1760 890 1805">1</td> <td data-bbox="898 1760 1055 1805">0</td> <td data-bbox="1063 1760 1251 1805">Start forward</td> </tr> <tr> <td data-bbox="569 1805 725 1850">0 -> 1</td> <td data-bbox="733 1805 890 1850">1</td> <td data-bbox="898 1805 1055 1850">1</td> <td data-bbox="1063 1805 1251 1850">Start reverse</td> </tr> <tr> <td data-bbox="569 1850 725 1888">Any</td> <td data-bbox="733 1850 890 1888">0</td> <td data-bbox="898 1850 1055 1888">Any</td> <td data-bbox="1063 1850 1251 1888">Stop</td> </tr> </tbody> </table> <p>Note: The start signal is always edge-triggered with this setting regardless of parameter 20.02 Ext1 start trigger type.</p>	State of source 1 (20.03)	State of source 2 (20.04)	State of source 3 (20.05)	Command	0 -> 1	1	0	Start forward	0 -> 1	1	1	Start reverse	Any	0	Any	Stop	5
State of source 1 (20.03)	State of source 2 (20.04)	State of source 3 (20.05)	Command																
0 -> 1	1	0	Start forward																
0 -> 1	1	1	Start reverse																
Any	0	Any	Stop																

No.	Name/Value	Description	Def/FbEq16																
	In1P Start fwd; In2P Start rev; In3 Stop	<p>The sources of the start and stop commands are selected by parameters 20.03 Ext1 in1 source, 20.04 Ext1 in2 source and 20.05 Ext1 in3 source. The state transitions of the source bits are interpreted as follows:</p> <table border="1"> <thead> <tr> <th>State of source 1 (20.03)</th> <th>State of source 2 (20.04)</th> <th>State of source 3 (20.05)</th> <th>Command</th> </tr> </thead> <tbody> <tr> <td>0 -> 1</td> <td>Any</td> <td>1</td> <td>Start forward</td> </tr> <tr> <td>Any</td> <td>0 -> 1</td> <td>1</td> <td>Start reverse</td> </tr> <tr> <td>Any</td> <td>Any</td> <td>0</td> <td>Stop</td> </tr> </tbody> </table> <p>Note: The start signal is always edge-triggered with this setting regardless of parameter 20.02 Ext1 start trigger type.</p>	State of source 1 (20.03)	State of source 2 (20.04)	State of source 3 (20.05)	Command	0 -> 1	Any	1	Start forward	Any	0 -> 1	1	Start reverse	Any	Any	0	Stop	6
State of source 1 (20.03)	State of source 2 (20.04)	State of source 3 (20.05)	Command																
0 -> 1	Any	1	Start forward																
Any	0 -> 1	1	Start reverse																
Any	Any	0	Stop																
	Control panel	The start and stop commands are taken from the control panel.	11																
	Fieldbus A	<p>The start and stop commands are taken from fieldbus adapter A.</p> <p>Note: The start signal is always level-triggered with this setting regardless of parameter 20.02 Ext1 start trigger type.</p>	12																
	Embedded fieldbus	<p>The start and stop commands are taken from the embedded fieldbus interface.</p> <p>Note: The start signal is always level-triggered with this setting regardless of parameter 20.02 Ext1 start trigger type.</p>	14																
	M/F link	<p>The start and stop commands are taken from another drive through the master/follower link.</p> <p>Note: The start signal is always level-triggered with this setting regardless of parameter 20.02 Ext1 start trigger type.</p>	15																
	Application Program	<p>The start and stop commands are taken from the application program control word (parameter 06.02 Application control word).</p> <p>Note: The start signal is always level-triggered with this setting regardless of parameter 20.02 Ext1 start trigger type.</p>	21																
	ATF	Reserved.	22																

No.	Name/Value	Description	Def/FbEq16
20.02	<i>Ext1 start trigger type</i>	Defines whether the start signal for external control location EXT1 is edge-triggered or level-triggered. Note: This parameter is only effective when parameter <i>20.01 Ext1 commands</i> is set to <i>In1 Start</i> , <i>In1 Start; In2 Dir</i> , <i>In1 Start fwd</i> ; <i>In2 Start rev</i> , or <i>Control panel</i> .	<i>Edge</i>
	Edge	The start signal is edge-triggered.	0
	Level	The start signal is level-triggered.	1
20.03	<i>Ext1 in1 source</i>	Selects source 1 for parameter <i>20.01 Ext1 commands</i> .	<i>DI1</i>
	Not selected	0 (always off).	0
	Selected	1 (always on).	1
	DI1	Digital input DI1 (<i>10.02 DI delayed status</i> , bit 0).	2
	DI2	Digital input DI2 (<i>10.02 DI delayed status</i> , bit 1).	3
	DI3	Digital input DI3 (<i>10.02 DI delayed status</i> , bit 2).	4
	DI4	Digital input DI4 (<i>10.02 DI delayed status</i> , bit 3).	5
	DI5	Digital input DI5 (<i>10.02 DI delayed status</i> , bit 4).	6
	DI6	Digital input DI6 (<i>10.02 DI delayed status</i> , bit 5).	7
	DIO1	Digital input/output DIO1 (<i>11.02 DIO delayed status</i> , bit 0).	10
	DIO2	Digital input/output DIO2 (<i>11.02 DIO delayed status</i> , bit 1).	11
	<i>Other [bit]</i>	Source selection (see <i>Terms and abbreviations</i> on page 90).	-
20.04	<i>Ext1 in2 source</i>	Selects source 2 for parameter <i>20.01 Ext1 commands</i> . For the available selections, see parameter <i>20.03 Ext1 in1 source</i> .	<i>DI2</i>
20.05	<i>Ext1 in3 source</i>	Selects source 3 for parameter <i>20.01 Ext1 commands</i> . For the available selections, see parameter <i>20.03 Ext1 in1 source</i> .	<i>Not selected</i>
20.06	<i>Ext2 commands</i>	Selects the source of start, stop and direction commands for external control location 2 (EXT2). See also parameters <i>20.07...20.10</i> .	<i>Not selected</i>
	Not selected	No start or stop command sources selected.	0

No.	Name/Value	Description	Def/FbEq16											
	In1 Start	<p>The source of the start and stop commands is selected by parameter 20.08 Ext2 in1 source. The state transitions of the source bits are interpreted as follows:</p> <table border="1" data-bbox="540 421 1083 591"> <thead> <tr> <th>State of source 1 (20.08)</th> <th>Command</th> </tr> </thead> <tbody> <tr> <td>0 -> 1 (20.07 = Edge)</td> <td>Start</td> </tr> <tr> <td>1 (20.07 = Level)</td> <td>Stop</td> </tr> </tbody> </table>	State of source 1 (20.08)	Command	0 -> 1 (20.07 = Edge)	Start	1 (20.07 = Level)	Stop	1					
State of source 1 (20.08)	Command													
0 -> 1 (20.07 = Edge)	Start													
1 (20.07 = Level)	Stop													
	In1 Start; In2 Dir	<p>The source selected by 20.08 Ext2 in1 source is the start signal; the source selected by 20.09 Ext2 in2 source determines the direction. The state transitions of the source bits are interpreted as follows:</p> <table border="1" data-bbox="489 835 1177 1115"> <thead> <tr> <th>State of source 1 (20.08)</th> <th>State of source 2 (20.09)</th> <th>Command</th> </tr> </thead> <tbody> <tr> <td>0</td> <td>Any</td> <td>Stop</td> </tr> <tr> <td rowspan="2">0 -> 1 (20.07 = Edge) 1 (20.07 = Level)</td> <td>0</td> <td>Start forward</td> </tr> <tr> <td>1</td> <td>Start reverse</td> </tr> </tbody> </table>	State of source 1 (20.08)	State of source 2 (20.09)	Command	0	Any	Stop	0 -> 1 (20.07 = Edge) 1 (20.07 = Level)	0	Start forward	1	Start reverse	2
State of source 1 (20.08)	State of source 2 (20.09)	Command												
0	Any	Stop												
0 -> 1 (20.07 = Edge) 1 (20.07 = Level)	0	Start forward												
	1	Start reverse												
	In1 Start fwd; In2 Start rev	<p>The source selected by 20.08 Ext2 in1 source is the forward start signal; the source selected by 20.09 Ext2 in2 source is the reverse start signal. The state transitions of the source bits are interpreted as follows:</p> <table border="1" data-bbox="489 1361 1177 1731"> <thead> <tr> <th>State of source 1 (20.08)</th> <th>State of source 2 (20.09)</th> <th>Command</th> </tr> </thead> <tbody> <tr> <td>0</td> <td>0</td> <td>Stop</td> </tr> <tr> <td rowspan="2">0 -> 1 (20.07 = Edge) 1 (20.07 = Level)</td> <td>0</td> <td>Start forward</td> </tr> <tr> <td>0 -> 1 (20.07 = Edge) 1 (20.07 = Level)</td> <td>Start reverse</td> </tr> </tbody> </table>	State of source 1 (20.08)	State of source 2 (20.09)	Command	0	0	Stop	0 -> 1 (20.07 = Edge) 1 (20.07 = Level)	0	Start forward	0 -> 1 (20.07 = Edge) 1 (20.07 = Level)	Start reverse	3
State of source 1 (20.08)	State of source 2 (20.09)	Command												
0	0	Stop												
0 -> 1 (20.07 = Edge) 1 (20.07 = Level)	0	Start forward												
	0 -> 1 (20.07 = Edge) 1 (20.07 = Level)	Start reverse												

No.	Name/Value	Description	Def/FbEq16																
	In1P Start; In2 Stop	<p>The sources of the start and stop commands are selected by parameters 20.08 Ext2 in1 source and 20.09 Ext2 in2 source. The state transitions of the source bits are interpreted as follows:</p> <table border="1" data-bbox="569 421 1243 584"> <thead> <tr> <th data-bbox="569 421 816 495">State of source 1 (20.08)</th> <th data-bbox="816 421 1067 495">State of source 2 (20.09)</th> <th data-bbox="1067 421 1243 495">Command</th> </tr> </thead> <tbody> <tr> <td data-bbox="569 495 816 539">0 -> 1</td> <td data-bbox="816 495 1067 539">1</td> <td data-bbox="1067 495 1243 539">Start</td> </tr> <tr> <td data-bbox="569 539 816 584">Any</td> <td data-bbox="816 539 1067 584">0</td> <td data-bbox="1067 539 1243 584">Stop</td> </tr> </tbody> </table> <p>Note: The start signal is always edge-triggered with this setting regardless of parameter 20.07 Ext2 start trigger type.</p>	State of source 1 (20.08)	State of source 2 (20.09)	Command	0 -> 1	1	Start	Any	0	Stop	4							
State of source 1 (20.08)	State of source 2 (20.09)	Command																	
0 -> 1	1	Start																	
Any	0	Stop																	
	In1P Start; In2 Stop; In3 Dir	<p>The sources of the start and stop commands are selected by parameters 20.08 Ext2 in1 source and 20.09 Ext2 in2 source. The source selected by 20.10 Ext2 in3 source determines the direction. The state transitions of the source bits are interpreted as follows:</p> <table border="1" data-bbox="569 981 1243 1223"> <thead> <tr> <th data-bbox="569 981 733 1093">State of source 1 (20.08)</th> <th data-bbox="733 981 898 1093">State of source 2 (20.09)</th> <th data-bbox="898 981 1063 1093">State of source 3 (20.10)</th> <th data-bbox="1063 981 1243 1093">Command</th> </tr> </thead> <tbody> <tr> <td data-bbox="569 1093 733 1137">0 -> 1</td> <td data-bbox="733 1093 898 1137">1</td> <td data-bbox="898 1093 1063 1137">0</td> <td data-bbox="1063 1093 1243 1137">Start forward</td> </tr> <tr> <td data-bbox="569 1137 733 1182">0 -> 1</td> <td data-bbox="733 1137 898 1182">1</td> <td data-bbox="898 1137 1063 1182">1</td> <td data-bbox="1063 1137 1243 1182">Start reverse</td> </tr> <tr> <td data-bbox="569 1182 733 1223">Any</td> <td data-bbox="733 1182 898 1223">0</td> <td data-bbox="898 1182 1063 1223">Any</td> <td data-bbox="1063 1182 1243 1223">Stop</td> </tr> </tbody> </table> <p>Note: The start signal is always edge-triggered with this setting regardless of parameter 20.07 Ext2 start trigger type.</p>	State of source 1 (20.08)	State of source 2 (20.09)	State of source 3 (20.10)	Command	0 -> 1	1	0	Start forward	0 -> 1	1	1	Start reverse	Any	0	Any	Stop	5
State of source 1 (20.08)	State of source 2 (20.09)	State of source 3 (20.10)	Command																
0 -> 1	1	0	Start forward																
0 -> 1	1	1	Start reverse																
Any	0	Any	Stop																
	In1P Start fwd; In2P Start rev; In3 Stop	<p>The sources of the start and stop commands are selected by parameters 20.08 Ext2 in1 source, 20.09 Ext2 in2 source and 20.10 Ext2 in3 source. The state transitions of the source bits are interpreted as follows:</p> <table border="1" data-bbox="569 1592 1243 1834"> <thead> <tr> <th data-bbox="569 1592 733 1704">State of source 1 (20.08)</th> <th data-bbox="733 1592 898 1704">State of source 2 (20.09)</th> <th data-bbox="898 1592 1063 1704">State of source 3 (20.10)</th> <th data-bbox="1063 1592 1243 1704">Command</th> </tr> </thead> <tbody> <tr> <td data-bbox="569 1704 733 1749">0 -> 1</td> <td data-bbox="733 1704 898 1749">Any</td> <td data-bbox="898 1704 1063 1749">1</td> <td data-bbox="1063 1704 1243 1749">Start forward</td> </tr> <tr> <td data-bbox="569 1749 733 1794">Any</td> <td data-bbox="733 1749 898 1794">0 -> 1</td> <td data-bbox="898 1749 1063 1794">1</td> <td data-bbox="1063 1749 1243 1794">Start reverse</td> </tr> <tr> <td data-bbox="569 1794 733 1834">Any</td> <td data-bbox="733 1794 898 1834">Any</td> <td data-bbox="898 1794 1063 1834">0</td> <td data-bbox="1063 1794 1243 1834">Stop</td> </tr> </tbody> </table> <p>Note: The start signal is always edge-triggered with this setting regardless of parameter 20.07 Ext2 start trigger type.</p>	State of source 1 (20.08)	State of source 2 (20.09)	State of source 3 (20.10)	Command	0 -> 1	Any	1	Start forward	Any	0 -> 1	1	Start reverse	Any	Any	0	Stop	6
State of source 1 (20.08)	State of source 2 (20.09)	State of source 3 (20.10)	Command																
0 -> 1	Any	1	Start forward																
Any	0 -> 1	1	Start reverse																
Any	Any	0	Stop																
	Control panel	The start and stop commands are taken from the control panel.	11																

No.	Name/Value	Description	Def/FbEq16
	Fieldbus A	The start and stop commands are taken from fieldbus adapter A. Note: The start signal is always level-triggered with this setting regardless of parameter 20.07 Ext2 start trigger type .	12
	Embedded fieldbus	The start and stop commands are taken from the embedded fieldbus interface. Note: The start signal is always level-triggered with this setting regardless of parameter 20.07 Ext2 start trigger type .	14
	M/F link	The start and stop commands are taken from another drive through the master/follower link. Note: The start signal is always level-triggered with this setting regardless of parameter 20.07 Ext2 start trigger type .	15
	Application Program	The start and stop commands are taken from the application program control word (parameter 06.02 Application control word). Note: The start signal is always level-triggered with this setting regardless of parameter 20.07 Ext2 start trigger type .	21
	ATF	Reserved.	22
20.07	Ext2 start trigger type	Defines whether the start signal for external control location EXT2 is edge-triggered or level-triggered. Note: This parameter is only effective when parameter 20.06 Ext2 commands is set to In1 Start , In1 Start; In2 Dir , In1 Start fwd ; In2 Start rev , or Control panel .	Edge
	Edge	The start signal is edge-triggered.	0
	Level	The start signal is level-triggered.	1
20.08	Ext2 in1 source	Selects source 1 for parameter 20.06 Ext2 commands . For the available selections, see parameter 20.03 Ext1 in1 source .	Not selected
20.09	Ext2 in2 source	Selects source 2 for parameter 20.06 Ext2 commands . For the available selections, see parameter 20.03 Ext1 in1 source .	Not selected
20.10	Ext2 in3 source	Selects source 3 for parameter 20.06 Ext2 commands . For the available selections, see parameter 20.03 Ext1 in1 source .	Not selected

No.	Name/Value	Description	Def/FbEq16
20.11	<i>Run enable stop mode</i>	Selects the way the motor is stopped when the run enable signal switches off. The source of the run enable signal is selected by parameter <i>20.12 Run enable 1 source</i> .	<i>Coast</i> (95.20 b10)
	Coast	Stop by switching off the output semiconductors of the drive. The motor coasts to a stop.  WARNING! If a mechanical brake is used, ensure it is safe to stop the drive by coasting.	0
	Ramp	Stop along the active deceleration ramp. See parameter group <i>23 Speed reference ramp</i> on page 209.	1
	Torque limit	Stop according to torque limits (parameters <i>30.19</i> and <i>30.20</i>).	2
20.12	<i>Run enable 1 source</i>	Selects the source of the external run enable signal. If the run enable signal is switched off, the drive will not start. If already running, the drive will stop according to the setting of parameter <i>20.11 Run enable stop mode</i> . 1 = Run enable signal on. Note: The warning that indicates a missing signal can be suppressed using parameter <i>20.30 Enable signals warning function</i> . See also parameter <i>20.19 Enable start command</i> .	<i>DIIL</i> (95.20 b10); <i>Selected</i> (95.20 b5); <i>D15</i> (95.20 b9)
	Not selected	0.	0
	Selected	1.	1
	DI1	Digital input DI1 (<i>10.02 DI delayed status</i> , bit 0).	2
	DI2	Digital input DI2 (<i>10.02 DI delayed status</i> , bit 1).	3
	DI3	Digital input DI3 (<i>10.02 DI delayed status</i> , bit 2).	4
	DI4	Digital input DI4 (<i>10.02 DI delayed status</i> , bit 3).	5
	DI5	Digital input DI5 (<i>10.02 DI delayed status</i> , bit 4).	6
	DI6	Digital input DI6 (<i>10.02 DI delayed status</i> , bit 5).	7
	DIO1	Digital input/output DIO1 (<i>11.02 DIO delayed status</i> , bit 0).	10
	DIO2	Digital input/output DIO2 (<i>11.02 DIO delayed status</i> , bit 1).	11
	FBA A MCW bit 3	Control word bit 3 received through fieldbus interface A.	30
	EFB MCW bit 3	Control word bit 3 received through the embedded fieldbus interface.	32
	DIIL	DIIL input (<i>10.02 DI delayed status</i> , bit 15).	33

No.	Name/Value	Description	Def/FbEq16
	Active control source MCW bit 3	Control word bit 3 received from the active control source. In case the active source is the control panel, PC tool or drive I/O, the run enable signal is always on. Note: If the drive is running, switching bit 3 off effectively removes both the start and run enable signals. In this case, the stop mode is determined by either 20.11 Run enable stop mode or 21.03 Stop mode , whichever mode has higher priority. The order of stop modes from highest to lowest priority is Coast – Torque limit – Ramp .	34
	Other [bit]	Source selection (see Terms and abbreviations on page 90).	-
20.19	Enable start command	Selects the source for the start enable signal. 1 = Start enable. With the signal switched off, any drive start command is inhibited. (Switching the signal off while the drive is running will not stop the drive.) Notes: <ul style="list-style-type: none"> • If a level-triggered start command is on when the start enable signal switches on, the drive will start. (An edge-triggered start signal must be cycled for the drive to start.) See parameters 20.02 Ext1 start trigger type and 20.07 Ext2 start trigger type. • The warning that indicates a missing signal can be suppressed using parameter 20.30 Enable signals warning function. See also parameter 20.12 Run enable 1 source .	Selected
	Not selected	0.	0
	Selected	1.	1
	DI1	Digital input DI1 (10.02 DI delayed status , bit 0).	2
	DI2	Digital input DI2 (10.02 DI delayed status , bit 1).	3
	DI3	Digital input DI3 (10.02 DI delayed status , bit 2).	4
	DI4	Digital input DI4 (10.02 DI delayed status , bit 3).	5
	DI5	Digital input DI5 (10.02 DI delayed status , bit 4).	6
	DI6	Digital input DI6 (10.02 DI delayed status , bit 5).	7
	DIO1	Digital input/output DIO1 (11.02 DIO delayed status , bit 0).	10
	DIO2	Digital input/output DIO2 (11.02 DIO delayed status , bit 1).	11
	DIIL	DIIL input (10.02 DI delayed status , bit 15).	30

No.	Name/Value	Description	Def/FbEq16
	<i>Other [bit]</i>	Source selection (see <i>Terms and abbreviations</i> on page 90).	-
20.23	<i>Positive speed enable</i>	<p>Selects the source of the positive speed enable command.</p> <p>1 = Positive speed enabled. 0 = Positive speed interpreted as zero speed reference. In the figure below, <i>23.01 Speed ref ramp input</i> is set to zero after the positive speed enable signal has cleared.</p> <p>Actions in different control modes:</p> <p>Speed control: Speed reference is set to zero and the motor is stopped along the currently active deceleration ramp. The rush controller prevents additional torque terms from running the motor in the positive direction.</p> <p>Torque control: The rush controller monitors the rotation direction of the motor.</p>	<i>Selected</i>
		<p>Example: The motor is rotating in the forward direction. To stop the motor, the positive speed enable signal is deactivated by a hardware limit switch (e.g. via digital input). If the positive speed enable signal remains deactivated and the negative speed enable signal is active, only reverse rotation of the motor is allowed.</p>	
	Not selected	0.	0
	Selected	1.	1
	DI1	Digital input DI1 (<i>10.02 DI delayed status</i> , bit 0).	2
	DI2	Digital input DI2 (<i>10.02 DI delayed status</i> , bit 1).	3
	DI3	Digital input DI3 (<i>10.02 DI delayed status</i> , bit 2).	4
	DI4	Digital input DI4 (<i>10.02 DI delayed status</i> , bit 3).	5
	DI5	Digital input DI5 (<i>10.02 DI delayed status</i> , bit 4).	6

No.	Name/Value	Description	Def/FbEq16
	DI6	Digital input DI6 (10.02 DI delayed status , bit 5).	7
	DIO1	Digital input/output DIO1 (11.02 DIO delayed status , bit 0).	10
	DIO2	Digital input/output DIO2 (11.02 DIO delayed status , bit 1).	11
	<i>Other [bit]</i>	Source selection (see Terms and abbreviations on page 90).	-
20.24	Negative speed enable	Selects the source of the negative speed reference enable command. See parameter 20.23 Positive speed enable .	<i>Selected</i>
20.25	Jogging enable	Selects the source for a jog enable signal. (The sources for jogging activation signals are selected by parameters 20.26 Jogging 1 start source and 20.27 Jogging 2 start source .) 1 = Jogging is enabled. 0 = Jogging is disabled. Note: Jogging can be enabled only when no start command from an external control location is active. On the other hand, if jogging is already enabled, the drive cannot be started from an external control location (apart from inching commands through fieldbus). See section Jogging (page 57).	<i>Not selected</i>
	Not selected	0.	0
	Selected	1.	1
	DI1	Digital input DI1 (10.02 DI delayed status , bit 0).	2
	DI2	Digital input DI2 (10.02 DI delayed status , bit 1).	3
	DI3	Digital input DI3 (10.02 DI delayed status , bit 2).	4
	DI4	Digital input DI4 (10.02 DI delayed status , bit 3).	5
	DI5	Digital input DI5 (10.02 DI delayed status , bit 4).	6
	DI6	Digital input DI6 (10.02 DI delayed status , bit 5).	7
	DIO1	Digital input/output DIO1 (11.02 DIO delayed status , bit 0).	10
	DIO2	Digital input/output DIO2 (11.02 DIO delayed status , bit 1).	11
	<i>Other [bit]</i>	Source selection (see Terms and abbreviations on page 90).	-

No.	Name/Value	Description	Def/FbEq16
20.26	<i>Jogging 1 start source</i>	If enabled by parameter <i>20.25 Jogging enable</i> , selects the source for the activation of jogging function 1. (Jogging function 1 can also be activated through fieldbus regardless of parameter <i>20.25</i> .) 1 = Jogging 1 active. Note: If both jogging 1 and 2 are activated, the one that was activated first has priority.	<i>Not selected</i>
	Not selected	0.	0
	Selected	1.	1
	DI1	Digital input DI1 (<i>10.02 DI delayed status</i> , bit 0).	2
	DI2	Digital input DI2 (<i>10.02 DI delayed status</i> , bit 1).	3
	DI3	Digital input DI3 (<i>10.02 DI delayed status</i> , bit 2).	4
	DI4	Digital input DI4 (<i>10.02 DI delayed status</i> , bit 3).	5
	DI5	Digital input DI5 (<i>10.02 DI delayed status</i> , bit 4).	6
	DI6	Digital input DI6 (<i>10.02 DI delayed status</i> , bit 5).	7
	DIO1	Digital input/output DIO1 (<i>11.02 DIO delayed status</i> , bit 0).	10
	DIO2	Digital input/output DIO2 (<i>11.02 DIO delayed status</i> , bit 1).	11
	<i>Other [bit]</i>	Source selection (see <i>Terms and abbreviations</i> on page 90).	-
20.27	<i>Jogging 2 start source</i>	If enabled by parameter <i>20.25 Jogging enable</i> , selects the source for the activation of jogging function 2. (Jogging function 2 can also be activated through fieldbus regardless of parameter <i>20.25</i> .) 1 = Jogging 2 active. For the selections, see parameter <i>20.26 Jogging 1 start source</i> . Note: If both jogging 1 and 2 are activated, the one that was activated first has priority.	<i>Not selected</i>

No.	Name/Value	Description	Def/FbEq16												
20.30	<i>Enable signals warning function</i>	<p>Selects enable signal (eg. run enable, start enable) warnings to be suppressed. This parameter can be used to prevent these warnings from flooding the event log.</p> <p>Whenever a bit of this parameter is set to 1, the corresponding warning is suppressed, ie. no warning is generated even if the signal is switched off.</p> <p>The bits of this binary number correspond to the following warnings:</p>	00b												
<table border="1"> <thead> <tr> <th>Bit</th> <th>Name</th> <th>Warning</th> </tr> </thead> <tbody> <tr> <td>0</td> <td>Enable Start</td> <td><i>AFEA Enable start signal missing</i></td> </tr> <tr> <td>1</td> <td>Run enable 1</td> <td><i>AFEB Run enable missing</i></td> </tr> <tr> <td>2...15</td> <td>Reserved</td> <td></td> </tr> </tbody> </table>				Bit	Name	Warning	0	Enable Start	<i>AFEA Enable start signal missing</i>	1	Run enable 1	<i>AFEB Run enable missing</i>	2...15	Reserved	
Bit	Name	Warning													
0	Enable Start	<i>AFEA Enable start signal missing</i>													
1	Run enable 1	<i>AFEB Run enable missing</i>													
2...15	Reserved														
00b...11b		Suppression of “enable signal missing” warnings.	1 = 1												
21 Start/stop mode		Start and stop modes; emergency stop mode and signal source selection; DC magnetization settings; autophasing mode selection.													
21.01	<i>Start mode</i>	<p>Selects the motor start function for the DTC motor control mode, ie. when <i>99.04 Motor control mode</i> is set to <i>DTC</i>.</p> <p>Notes:</p> <ul style="list-style-type: none"> The start function for the scalar motor control mode is selected by parameter <i>21.19 Scalar start mode</i>. Starting into a rotating motor is not possible when DC magnetizing is selected (<i>Fast</i> or <i>Constant time</i>). With permanent magnet motors and synchronous reluctance motors, <i>Automatic</i> start mode must be used. This parameter cannot be changed while the drive is running. <p>See also section <i>DC magnetization</i> (page 64).</p>	<i>Automatic</i>												
Fast		The drive pre-magnetizes the motor before start. The pre-magnetizing time is determined automatically, being typically 200 ms to 2 s depending on motor size. This mode should be selected if a high break-away torque is required.	0												

No.	Name/Value	Description	<i>Def/FbEq16</i>
	Constant time	<p>The drive pre-magnetizes the motor before start. The pre-magnetizing time is defined by parameter 21.02 Magnetization time. This mode should be selected if constant pre-magnetizing time is required (e.g. if the motor start must be synchronized with the release of a mechanical brake). This setting also guarantees the highest possible break-away torque when the pre-magnetizing time is set long enough.</p> <p> WARNING! The drive will start after the set magnetizing time has passed even if motor magnetization is not completed. In applications where a full break-away torque is essential, ensure that the constant magnetizing time is long enough to allow generation of full magnetization and torque.</p>	1
	Automatic	<p>Automatic start guarantees optimal motor start in most cases. It includes the flying start function (starting into a rotating motor) and the automatic restart function (a stopped motor can be restarted immediately without waiting the motor flux to die away). The drive motor control program identifies the flux as well as the mechanical state of the motor and starts the motor instantly under all conditions.</p>	2

No.	Name/Value	Description	Def/FbEq16										
21.02	<i>Magnetization time</i>	<p>Defines the pre-magnetization time when</p> <ul style="list-style-type: none"> parameter <i>21.01 Start mode</i> is set to <i>Constant time</i> (in DTC motor control mode), or parameter <i>21.19 Scalar start mode</i> is set to <i>Const time</i> (in scalar motor control mode). <p>After the start command, the drive automatically premagnetizes the motor for the set time. To ensure full magnetizing, set this parameter to the same value as, or higher than, the rotor time constant. If not known, use the rule-of-thumb value given in the table below:</p> <table border="1" data-bbox="508 703 1154 1005"> <thead> <tr> <th>Motor rated power</th> <th>Constant magnetizing time</th> </tr> </thead> <tbody> <tr> <td>< 1 kW</td> <td>≥ 50 to 100 ms</td> </tr> <tr> <td>1 to 10 kW</td> <td>≥ 100 to 200 ms</td> </tr> <tr> <td>10 to 200 kW</td> <td>≥ 200 to 1000 ms</td> </tr> <tr> <td>200 to 1000 kW</td> <td>≥ 1000 to 2000 ms</td> </tr> </tbody> </table> <p>Note: This parameter cannot be changed while the drive is running.</p>	Motor rated power	Constant magnetizing time	< 1 kW	≥ 50 to 100 ms	1 to 10 kW	≥ 100 to 200 ms	10 to 200 kW	≥ 200 to 1000 ms	200 to 1000 kW	≥ 1000 to 2000 ms	500 ms
Motor rated power	Constant magnetizing time												
< 1 kW	≥ 50 to 100 ms												
1 to 10 kW	≥ 100 to 200 ms												
10 to 200 kW	≥ 200 to 1000 ms												
200 to 1000 kW	≥ 1000 to 2000 ms												
	0 ... 10000 ms	Constant DC magnetizing time.	1 = 1 ms										
21.03	<i>Stop mode</i>	<p>Selects the way the motor is stopped when a stop command is received.</p> <p>Additional braking is possible by selecting flux braking (see parameter <i>97.05 Flux braking</i>).</p> <p>Note: This parameter has no effect in a follower drive in a master/follower configuration.</p>	<i>Coast</i>										
	Coast	<p>Stop by switching off the output semiconductors of the drive. The motor coasts to a stop.</p> <p> WARNING! If a mechanical brake is used, ensure it is safe to stop the drive by coasting.</p>	0										
	Ramp	Stop along the active deceleration ramp. See parameter group <i>23 Speed reference ramp</i> on page <i>209</i> .	1										
	Torque limit	Stop according to torque limits (parameters <i>30.19</i> and <i>30.20</i>).	2										

No.	Name/Value	Description	Def/FbEq16
21.04	<i>Emergency stop mode</i>	<p>Selects the way the motor is stopped when an emergency stop command is received.</p> <p>The source of the emergency stop signal is selected by parameter 21.05 Emergency stop source.</p>	Ramp stop (Off1) ; Coast stop (Off2) (95.20 b1); Eme ramp stop (Off3) (95.20 b2)
	Ramp stop (Off1)	<p>With the drive running:</p> <ul style="list-style-type: none"> • 1 = Normal operation. • 0 = Normal stop along the standard deceleration ramp defined for the particular reference type (see section Reference ramping [page 45]). After the drive has stopped, it can be restarted by removing the emergency stop signal and switching the start signal from 0 to 1. <p>With the drive stopped:</p> <ul style="list-style-type: none"> • 1 = Starting allowed. • 0 = Starting not allowed. 	0
	Coast stop (Off2)	<p>With the drive running:</p> <ul style="list-style-type: none"> • 1 = Normal operation. • 0 = Stop by coasting. The drive can be restarted by restoring the start interlock signal and switching the start signal from 0 to 1. <p>With the drive stopped:</p> <ul style="list-style-type: none"> • 1 = Starting allowed. • 0 = Starting not allowed. 	1
	Eme ramp stop (Off3)	<p>With the drive running:</p> <ul style="list-style-type: none"> • 1 = Normal operation. • 0 = Stop by ramping along emergency stop ramp defined by parameter 23.23 Emergency stop time. After the drive has stopped, it can be restarted by removing the emergency stop signal and switching the start signal from 0 to 1. <p>With the drive stopped:</p> <ul style="list-style-type: none"> • 1 = Starting allowed. • 0 = Starting not allowed. 	2
21.05	<i>Emergency stop source</i>	<p>Selects the source of the emergency stop signal. The stop mode is selected by parameter 21.04 Emergency stop mode.</p> <p>0 = Emergency stop active 1 = Normal operation</p> <p>Note: This parameter cannot be changed while the drive is running.</p>	Inactive (true) ; DI4 (95.20 b1, 95.20 b2)
	Active (false)	0.	0
	Inactive (true)	1.	1

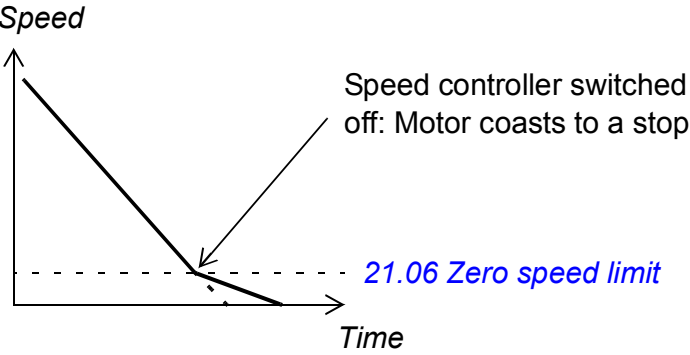
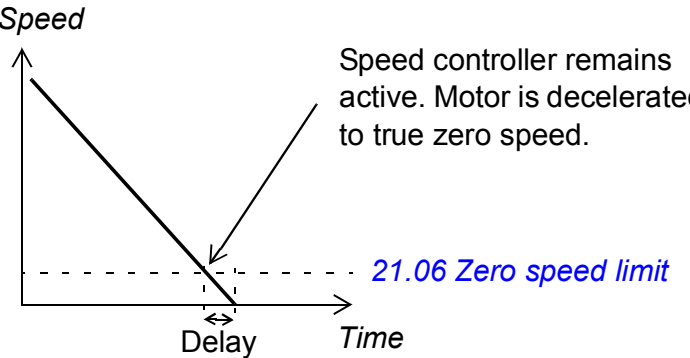

No.	Name/Value	Description	Def/FbEq16
	DIIL	DIIL input (10.02 DI delayed status , bit 15).	2
	DI1	Digital input DI1 (10.02 DI delayed status , bit 0).	3
	DI2	Digital input DI2 (10.02 DI delayed status , bit 1).	4
	DI3	Digital input DI3 (10.02 DI delayed status , bit 2).	5
	DI4	Digital input DI4 (10.02 DI delayed status , bit 3).	6
	DI5	Digital input DI5 (10.02 DI delayed status , bit 4).	7
	DI6	Digital input DI6 (10.02 DI delayed status , bit 5).	8
	DIO1	Digital input/output DIO1 (11.02 DIO delayed status , bit 0).	11
	DIO2	Digital input/output DIO2 (11.02 DIO delayed status , bit 1).	12
	<i>Other [bit]</i>	Source selection (see Terms and abbreviations on page 90).	-
21.06	<i>Zero speed limit</i>	Defines the zero speed limit. The motor is stopped along a speed ramp (when ramped stop is selected) until the defined zero speed limit is reached. After the zero speed delay, the motor coasts to a stop.	30.00 rpm
	0.00 ... 30000.00 rpm	Zero speed limit.	See par. 46.01

No.	Name/Value	Description	Def/FbEq16
21.07	<i>Zero speed delay</i>	<p>Defines the delay for the zero speed delay function. The function is useful in applications where a smooth and quick restarting is essential. During the delay, the drive knows the rotor position accurately.</p> <p><u>Without zero speed delay:</u></p> <p>The drive receives a stop command and decelerates along a ramp. When actual motor speed falls below the value of parameter 21.06 Zero speed limit, inverter modulation is stopped and the motor coasts to a standstill.</p>  <p><u>With zero speed delay:</u></p> <p>The drive receives a stop command and decelerates along a ramp. When actual motor speed falls below the value of parameter 21.06 Zero speed limit, the zero speed delay function activates. During the delay the function keeps the speed controller live: the inverter modulates, motor is magnetized and the drive is ready for a quick restart. Zero speed delay can be used e.g. with the jogging function.</p> 	0 ms
	0 ... 30000 ms	Zero speed delay.	1 = 1 ms

No.	Name/Value	Description	Def/FbEq16								
21.08	<i>DC current control</i>	<p>Activates/deactivates the DC hold and post-magnetization functions. See section <i>DC magnetization</i> (page 64).</p> <p>Notes:</p> <ul style="list-style-type: none"> • These functions are only available in speed control in DTC motor control mode (see page 28). • DC magnetization causes the motor to heat up. In applications where long DC magnetization times are required, externally ventilated motors should be used. If the DC magnetization period is long, DC magnetization cannot prevent the motor shaft from rotating if a constant load is applied to the motor. 	0000b								
<table border="1"> <thead> <tr> <th>Bit</th> <th>Value</th> </tr> </thead> <tbody> <tr> <td>0</td> <td>1 = Enable DC hold. See section <i>DC hold</i> (page 64). Note: The DC hold function has no effect if the start signal is switched off.</td> </tr> <tr> <td>1</td> <td>1 = Enable post-magnetization. See section <i>Post-magnetization</i> (page 65). Note: Post-magnetization is only available when ramping is the selected stop mode (see parameter <i>21.03 Stop mode</i>).</td> </tr> <tr> <td>2...15</td> <td>Reserved</td> </tr> </tbody> </table>				Bit	Value	0	1 = Enable DC hold. See section <i>DC hold</i> (page 64). Note: The DC hold function has no effect if the start signal is switched off.	1	1 = Enable post-magnetization. See section <i>Post-magnetization</i> (page 65). Note: Post-magnetization is only available when ramping is the selected stop mode (see parameter <i>21.03 Stop mode</i>).	2...15	Reserved
Bit	Value										
0	1 = Enable DC hold. See section <i>DC hold</i> (page 64). Note: The DC hold function has no effect if the start signal is switched off.										
1	1 = Enable post-magnetization. See section <i>Post-magnetization</i> (page 65). Note: Post-magnetization is only available when ramping is the selected stop mode (see parameter <i>21.03 Stop mode</i>).										
2...15	Reserved										
	0000b...0011b	DC magnetization selection.	1 = 1								
21.09	<i>DC hold speed</i>	Defines the DC hold speed. See parameter <i>21.08 DC current control</i> , and section <i>DC hold</i> (page 64).	5.00 rpm								
	0.00 ... 1000.00 rpm	DC hold speed.	See par. <i>46.01</i>								
21.10	<i>DC current reference</i>	Defines the DC hold current in percent of the motor nominal current. See parameter <i>21.08 DC current control</i> , and section <i>DC magnetization</i> (page 64).	30.0%								
	0.0 ... 100.0%	DC hold current.	1 = 1%								
21.11	<i>Post magnetization time</i>	Defines the length of time for which post-magnetization is active after stopping the motor. The magnetization current is defined by parameter <i>21.10 DC current reference</i> . See parameter <i>21.08 DC current control</i> .	0 s								
	0...3000 s	Post-magnetization time.	1 = 1 s								

No.	Name/Value	Description	Def/Fb/Eq16
21.12	<i>Continuous magnetization command</i>	<p>Activates/deactivates (or selects a source that activates/deactivates) continuous magnetization. See section <i>Continuous magnetization</i> (page 65). The magnetization current is calculated on the basis of flux reference (see parameter group 97 <i>Motor control</i>).</p> <p>Notes:</p> <ul style="list-style-type: none"> This function is only available when ramping is the selected stop mode (see parameter 21.03 <i>Stop mode</i>), and only in speed control in DTC motor control mode (see page 28). Continuous magnetization causes the motor to heat up. In applications where long magnetization times are required, externally ventilated motors should be used. Continuous magnetization may not be able to prevent the motor shaft from rotating during a long period if a constant load is applied to the motor. <p>0 = Normal operation 1 = Magnetization active</p>	<i>Off</i>
	Off	0.	0
	On	1.	1
	<i>Other [bit]</i>	Source selection (see <i>Terms and abbreviations</i> on page 90).	-
21.13	<i>Autophasing mode</i>	Selects the way autophasing is performed. See section <i>Autophasing</i> on page 60.	<i>Turning</i>
	Turning	<p>This mode gives the most accurate autophasing result. This mode can be used, and is recommended, if the motor is allowed to rotate and the start-up is not time-critical.</p> <p>Note: This mode will cause the motor to rotate. The load torque must be less than 5%.</p>	0
	Standstill 1	Faster than the <i>Turning</i> mode, but not as accurate. The motor will not rotate.	1
	Standstill 2	An alternative standstill autophasing mode that can be used if the <i>Turning</i> mode cannot be used, and the <i>Standstill 1</i> mode gives erratic results. However, this mode is considerably slower than <i>Standstill 1</i> .	2
	Turning with Z-pulse	This mode should be used if the zero pulse signal of the pulse encoder is to be observed, and other modes do not give a result. The motor will turn until a zero pulse is detected.	3



No.	Name/Value	Description	Def/FbEq16
21.14	<i>Pre-heating input source</i>	<p>Selects the source of the motor pre-heat on/off command. See section <i>Pre-heating</i> (page 64).</p> <p>Note: The pre-heating function will not activate if</p> <ul style="list-style-type: none"> • the Safe torque off function is active, • a fault is active, • less than one minute has elapsed after stopping, or • PID sleep function is active. <p>Pre-heating is deactivated when the drive is started, and overridden by pre-magnetization, post-magnetization or continuous magnetization.</p> <p>0 = Pre-heating inactive 1 = Pre-heating active</p>	<i>Off</i>
	Off	0. Pre-heating is always deactivated.	0
	On	1. Pre-heating is always activated when the drive is stopped (apart from conditions stated above).	1
	DI1	Digital input DI1 (<i>10.02 DI delayed status</i> , bit 0).	2
	DI2	Digital input DI2 (<i>10.02 DI delayed status</i> , bit 1).	3
	DI3	Digital input DI3 (<i>10.02 DI delayed status</i> , bit 2).	4
	DI4	Digital input DI4 (<i>10.02 DI delayed status</i> , bit 3).	5
	DI5	Digital input DI5 (<i>10.02 DI delayed status</i> , bit 4).	6
	DI6	Digital input DI6 (<i>10.02 DI delayed status</i> , bit 5).	7
	Supervision 1	Supervision 1 active (<i>32.01 Supervision status</i> , bit 0).	8
	Supervision 2	Supervision 2 active (<i>32.01 Supervision status</i> , bit 1).	9
	Supervision 3	Supervision 3 active (<i>32.01 Supervision status</i> , bit 2).	10
	<i>Other [bit]</i>	Source selection (see <i>Terms and abbreviations</i> on page 90).	-
21.16	<i>Pre-heating current</i>	<p>Defines the motor pre-heating current that is fed into the motor when the source selected by <i>21.14 Pre-heating input source</i> is on. The value is in percent of the nominal motor current.</p>	0.0%
	0.0 ... 30.0%	Pre-heating current.	1 = 1%

No.	Name/Value	Description	Def/FbEq16
21.18	<i>Auto restart time</i>	<p>The motor can be automatically started after a short supply power failure using the automatic restart function. See section <i>Automatic restart</i> (page 69).</p> <p>When this parameter is set to 0.0 seconds, automatic restarting is disabled. Otherwise, the parameter defines the maximum duration of the power failure after which restarting is attempted. Note that this time also includes the DC pre-charging delay.</p> <p> WARNING! Before you activate the function, make sure that no dangerous situations can occur. The function restarts the drive automatically and continues operation after a supply break.</p>	5.0 s
	0.0 s	Automatic restarting disabled.	0
	0.1 ... 5.0 s	Maximum power failure duration.	1 = 1 s
21.19	<i>Scalar start mode</i>	<p>Selects the motor start function for the scalar motor control mode, ie. when <i>99.04 Motor control mode</i> is set to <i>Scalar</i>.</p> <p>Notes:</p> <ul style="list-style-type: none"> • The start function for the DTC motor control mode is selected by parameter <i>21.01 Start mode</i>. • With permanent magnet motors, <i>Automatic</i> start mode must be used. • This parameter cannot be changed while the drive is running. <p>See also section <i>DC magnetization</i> (page 64).</p>	<i>Normal</i>
	Normal	Immediate start from zero speed.	0
	Const time	<p>The drive pre-magnetizes the motor before start. The pre-magnetizing time is defined by parameter <i>21.02 Magnetization time</i>. This mode should be selected if constant pre-magnetizing time is required (e.g. if the motor start must be synchronized with the release of a mechanical brake). This setting also guarantees the highest possible break-away torque when the pre-magnetizing time is set long enough.</p> <p>Note: This mode cannot be used to start into a rotating motor.</p> <p> WARNING! The drive will start after the set magnetizing time has passed even if motor magnetization is not completed. In applications where a full break-away torque is essential, ensure that the constant magnetizing time is long enough to allow generation of full magnetization and torque.</p>	1

No.	Name/Value	Description	Def/FbEq16
	Automatic	This setting should be used in applications where flying starts (ie. starting into a rotating motor) are required.	2
21.20	<i>Follower force ramp stop</i>	In a torque-controlled follower drive, forces (or selects a source that forces) the drive to switch to speed control upon a ramp stop (Off1 or Off3) command. This is required for an independent ramp stop of the follower. See also section <i>Master/follower functionality</i> (page 39). 1 = Ramp stop forces speed control	<i>Not selected</i>
	Not selected	0.	0
	Selected	1.	1
	DIIL	DIIL input (<i>10.02 DI delayed status</i> , bit 15).	2
	DI1	Digital input DI1 (<i>10.02 DI delayed status</i> , bit 0).	3
	DI2	Digital input DI2 (<i>10.02 DI delayed status</i> , bit 1).	4
	DI3	Digital input DI3 (<i>10.02 DI delayed status</i> , bit 2).	5
	DI4	Digital input DI4 (<i>10.02 DI delayed status</i> , bit 3).	6
	DI5	Digital input DI5 (<i>10.02 DI delayed status</i> , bit 4).	7
	DI6	Digital input DI6 (<i>10.02 DI delayed status</i> , bit 5).	8
	DIO1	Digital input/output DIO1 (<i>11.02 DIO delayed status</i> , bit 0).	11
	DIO2	Digital input/output DIO2 (<i>11.02 DIO delayed status</i> , bit 1).	12
	<i>Other [bit]</i>	Source selection (see <i>Terms and abbreviations</i> on page 90).	-
22 Speed reference selection		Speed reference selection; motor potentiometer settings. See the control chain diagrams on pages 566...568.	
22.01	<i>Speed ref unlimited</i>	Displays the output of the speed reference selection block. See the control chain diagram on page 567. This parameter is read-only.	-
	-30000.00 ... 30000.00 rpm	Value of the selected speed reference.	See par. 46.01

No.	Name/Value	Description	Def/FbEq16
22.11	<i>Speed ref1 source</i>	<p>Selects speed reference source 1.</p> <p>Two signal sources can be defined by this parameter and 22.12 Speed ref2 source. A digital source selected by 22.14 Speed ref1/2 selection can be used to switch between the two sources, or a mathematical function (22.13 Speed ref1 function) applied to the two signals to create the reference.</p>	<i>AI1 scaled</i>
	Zero	None.	0
	AI1 scaled	12.12 AI1 scaled value (see page 137).	1
	AI2 scaled	12.22 AI2 scaled value (see page 140).	2
	FB A ref1	03.05 FB A reference 1 (see page 98).	4
	FB A ref2	03.06 FB A reference 2 (see page 98).	5
	EFB ref1	03.09 EFB reference 1 (see page 98).	8
	EFB ref2	03.10 EFB reference 2 (see page 99).	9
	M/F reference 1	03.13 M/F or D2D ref1 (see page 99).	12
	M/F reference 2	03.14 M/F or D2D ref2 (see page 99).	13
	Motor potentiometer	22.80 Motor potentiometer ref act (output of the motor potentiometer).	15
	Control panel (ref saved)	Control panel reference, with initial value from last-used panel reference. See section Using the control panel as an external control source (page 27).	18
	Control panel (ref copied)	Control panel reference, with initial value from previous source or actual value. See section Using the control panel as an external control source (page 27).	19
	<i>Other</i>	Source selection (see Terms and abbreviations on page 90).	-

No.	Name/Value	Description	Def/FbEq16
22.12	<i>Speed ref2 source</i>	Selects speed reference source 2. For the selections, and a diagram of reference source selection, see parameter <i>22.11 Speed ref1 source</i> .	<i>Zero</i>
22.13	<i>Speed ref1 function</i>	Selects a mathematical function between the reference sources selected by parameters <i>22.11 Speed ref1 source</i> and <i>22.12 Speed ref2 source</i> . See diagram at <i>22.11 Speed ref1 source</i> .	<i>Ref1</i>
	Ref1	Signal selected by <i>22.11 Speed ref1 source</i> is used as speed reference 1 as such (no function applied).	0
	Add (ref1 + ref2)	The sum of the reference sources is used as speed reference 1.	1
	Sub (ref1 - ref2)	The subtraction (<i>[22.11 Speed ref1 source]</i> - <i>[22.12 Speed ref2 source]</i>) of the reference sources is used as speed reference 1.	2
	Mul (ref1 × ref2)	The multiplication of the reference sources is used as speed reference 1.	3
	Min (ref1, ref2)	The smaller of the reference sources is used as speed reference 1.	4
	Max (ref1, ref2)	The greater of the reference sources is used as speed reference 1.	5
22.14	<i>Speed ref1/2 selection</i>	Configures the selection between speed references 1 and 2. See diagram at <i>22.11 Speed ref1 source</i> . 0 = Speed reference 1 1 = Speed reference 2	<i>Follow Ext1/Ext2 selection</i>
	Speed reference 1	0.	0
	Speed reference 2	1.	1
	Follow Ext1/Ext2 selection	Speed reference 1 is used when external control location EXT1 is active. Speed reference 2 is used when external control location EXT2 is active. See also parameter <i>19.11 Ext1/Ext2 selection</i> .	2
	DI1	Digital input DI1 (<i>10.02 DI delayed status</i> , bit 0).	3
	DI2	Digital input DI2 (<i>10.02 DI delayed status</i> , bit 1).	4
	DI3	Digital input DI3 (<i>10.02 DI delayed status</i> , bit 2).	5
	DI4	Digital input DI4 (<i>10.02 DI delayed status</i> , bit 3).	6
	DI5	Digital input DI5 (<i>10.02 DI delayed status</i> , bit 4).	7
	DI6	Digital input DI6 (<i>10.02 DI delayed status</i> , bit 5).	8
	DIO1	Digital input/output DIO1 (<i>11.02 DIO delayed status</i> , bit 0).	11
	DIO2	Digital input/output DIO2 (<i>11.02 DIO delayed status</i> , bit 1).	12

No.	Name/Value	Description	Def/FbEq16															
	<i>Other [bit]</i>	Source selection (see <i>Terms and abbreviations</i> on page 90).	-															
22.15	<i>Speed additive 1 source</i>	Defines a reference to be added to the speed reference after reference selection (see page 566). For the selections, see parameter <i>22.11 Speed ref1 source</i> . Note: For safety reasons, the additive is not applied when any of the stop functions are active.	<i>Zero</i>															
22.16	<i>Speed share</i>	Defines a scaling factor for the selected speed reference (speed reference 1 or 2, multiplied by the defined value). Speed reference 1 or 2 is selected by parameter <i>22.14 Speed ref1/2 selection</i> .	1.000															
	-8.000 ... 8.000	Speed reference scaling factor.	1000 = 1															
22.17	<i>Speed additive 2 source</i>	Defines a reference to be added to the speed reference after the speed share function (see page 566). For the selections, see parameter <i>22.11 Speed ref1 source</i> . Note: For safety reasons, the additive is not applied when any of the stop functions are active.	<i>Zero</i>															
22.21	<i>Constant speed function</i>	Determines how constant speeds are selected, and whether the rotation direction signal is considered or not when applying a constant speed.	0000b															
		<table border="1"> <thead> <tr> <th>Bit</th> <th>Name</th> <th>Information</th> </tr> </thead> <tbody> <tr> <td rowspan="2">0</td> <td rowspan="2">Constant speed mode</td> <td>1 = Packed: 7 constant speeds are selectable using the three sources defined by parameters <i>22.22</i>, <i>22.23</i> and <i>22.24</i>.</td> </tr> <tr> <td>0 = Separate: Constant speeds 1, 2 and 3 are separately activated by the sources defined by parameters <i>22.22</i>, <i>22.23</i> and <i>22.24</i> respectively. In case of conflict, the constant speed with the smaller number takes priority.</td> </tr> <tr> <td rowspan="3">1</td> <td rowspan="3">Direction enable</td> <td>1 = Start dir: To determine running direction for a constant speed, the sign of the constant speed setting (parameters <i>22.26...22.32</i>) is multiplied by the direction signal (forward: +1, reverse: -1). This effectively allows the drive to have 14 (7 forward, 7 reverse) constant speeds if all values in <i>22.26...22.32</i> are positive.  WARNING: If the direction signal is reverse and the active constant speed is negative, the drive will run in the forward direction.</td> </tr> <tr> <td>0 = Accord Par: The running direction for the constant speed is determined by the sign of the constant speed setting (parameters <i>22.26...22.32</i>).</td> </tr> <tr> <td></td> </tr> <tr> <td>2...15</td> <td>Reserved</td> <td></td> </tr> </tbody> </table>	Bit	Name	Information	0	Constant speed mode	1 = Packed: 7 constant speeds are selectable using the three sources defined by parameters <i>22.22</i> , <i>22.23</i> and <i>22.24</i> .	0 = Separate: Constant speeds 1, 2 and 3 are separately activated by the sources defined by parameters <i>22.22</i> , <i>22.23</i> and <i>22.24</i> respectively. In case of conflict, the constant speed with the smaller number takes priority.	1	Direction enable	1 = Start dir: To determine running direction for a constant speed, the sign of the constant speed setting (parameters <i>22.26...22.32</i>) is multiplied by the direction signal (forward: +1, reverse: -1). This effectively allows the drive to have 14 (7 forward, 7 reverse) constant speeds if all values in <i>22.26...22.32</i> are positive.  WARNING: If the direction signal is reverse and the active constant speed is negative, the drive will run in the forward direction.	0 = Accord Par: The running direction for the constant speed is determined by the sign of the constant speed setting (parameters <i>22.26...22.32</i>).		2...15	Reserved		
Bit	Name	Information																
0	Constant speed mode	1 = Packed: 7 constant speeds are selectable using the three sources defined by parameters <i>22.22</i> , <i>22.23</i> and <i>22.24</i> .																
		0 = Separate: Constant speeds 1, 2 and 3 are separately activated by the sources defined by parameters <i>22.22</i> , <i>22.23</i> and <i>22.24</i> respectively. In case of conflict, the constant speed with the smaller number takes priority.																
1	Direction enable	1 = Start dir: To determine running direction for a constant speed, the sign of the constant speed setting (parameters <i>22.26...22.32</i>) is multiplied by the direction signal (forward: +1, reverse: -1). This effectively allows the drive to have 14 (7 forward, 7 reverse) constant speeds if all values in <i>22.26...22.32</i> are positive.  WARNING: If the direction signal is reverse and the active constant speed is negative, the drive will run in the forward direction.																
		0 = Accord Par: The running direction for the constant speed is determined by the sign of the constant speed setting (parameters <i>22.26...22.32</i>).																
2...15	Reserved																	
	0000b...0011b	Constant speed configuration word.	1 = 1															

No.	Name/Value	Description	Def/FbEq16																																				
22.22	<i>Constant speed sel1</i>	<p>When bit 0 of parameter 22.21 Constant speed function is 0 (Separate), selects a source that activates constant speed 1.</p> <p>When bit 0 of parameter 22.21 Constant speed function is 1 (Packed), this parameter and parameters 22.23 Constant speed sel2 and 22.24 Constant speed sel3 select three sources whose states activate constant speeds as follows:</p>	<i>DI5</i>																																				
<table border="1"> <thead> <tr> <th>Source defined by par. 22.22</th> <th>Source defined by par. 22.23</th> <th>Source defined by par. 22.24</th> <th>Constant speed active</th> </tr> </thead> <tbody> <tr> <td>0</td> <td>0</td> <td>0</td> <td>None</td> </tr> <tr> <td>1</td> <td>0</td> <td>0</td> <td>Constant speed 1</td> </tr> <tr> <td>0</td> <td>1</td> <td>0</td> <td>Constant speed 2</td> </tr> <tr> <td>1</td> <td>1</td> <td>0</td> <td>Constant speed 3</td> </tr> <tr> <td>0</td> <td>0</td> <td>1</td> <td>Constant speed 4</td> </tr> <tr> <td>1</td> <td>0</td> <td>1</td> <td>Constant speed 5</td> </tr> <tr> <td>0</td> <td>1</td> <td>1</td> <td>Constant speed 6</td> </tr> <tr> <td>1</td> <td>1</td> <td>1</td> <td>Constant speed 7</td> </tr> </tbody> </table>				Source defined by par. 22.22	Source defined by par. 22.23	Source defined by par. 22.24	Constant speed active	0	0	0	None	1	0	0	Constant speed 1	0	1	0	Constant speed 2	1	1	0	Constant speed 3	0	0	1	Constant speed 4	1	0	1	Constant speed 5	0	1	1	Constant speed 6	1	1	1	Constant speed 7
Source defined by par. 22.22	Source defined by par. 22.23	Source defined by par. 22.24	Constant speed active																																				
0	0	0	None																																				
1	0	0	Constant speed 1																																				
0	1	0	Constant speed 2																																				
1	1	0	Constant speed 3																																				
0	0	1	Constant speed 4																																				
1	0	1	Constant speed 5																																				
0	1	1	Constant speed 6																																				
1	1	1	Constant speed 7																																				
	Not selected	0 (always off).	0																																				
	Selected	1 (always on).	1																																				
	DI1	Digital input DI1 (10.02 DI delayed status , bit 0).	2																																				
	DI2	Digital input DI2 (10.02 DI delayed status , bit 1).	3																																				
	DI3	Digital input DI3 (10.02 DI delayed status , bit 2).	4																																				
	DI4	Digital input DI4 (10.02 DI delayed status , bit 3).	5																																				
	DI5	Digital input DI5 (10.02 DI delayed status , bit 4).	6																																				
	DI6	Digital input DI6 (10.02 DI delayed status , bit 5).	7																																				
	DIO1	Digital input/output DIO1 (11.02 DIO delayed status , bit 0).	10																																				
	DIO2	Digital input/output DIO2 (11.02 DIO delayed status , bit 1).	11																																				
	<i>Other [bit]</i>	Source selection (see Terms and abbreviations on page 90).	-																																				

No.	Name/Value	Description	Def/FbEq16
22.23	Constant speed sel2	When bit 0 of parameter 22.21 Constant speed function is 0 (Separate), selects a source that activates constant speed 2. When bit 0 of parameter 22.21 Constant speed function is 1 (Packed), this parameter and parameters 22.22 Constant speed sel1 and 22.24 Constant speed sel3 select three sources that are used to activate constant speeds. See table at parameter 22.22 Constant speed sel1 . For the selections, see parameter 22.22 Constant speed sel1 .	Not selected
22.24	Constant speed sel3	When bit 0 of parameter 22.21 Constant speed function is 0 (Separate), selects a source that activates constant speed 3. When bit 0 of parameter 22.21 Constant speed function is 1 (Packed), this parameter and parameters 22.22 Constant speed sel1 and 22.23 Constant speed sel2 select three sources that are used to activate constant speeds. See table at parameter 22.22 Constant speed sel1 . For the selections, see parameter 22.22 Constant speed sel1 .	Not selected
22.26	Constant speed 1	Defines constant speed 1 (the speed the motor will turn when constant speed 1 is selected).	300.00 rpm
	-30000.00 ... 30000.00 rpm	Constant speed 1.	See par. 46.01
22.27	Constant speed 2	Defines constant speed 2.	0.00 rpm
	-30000.00 ... 30000.00 rpm	Constant speed 2.	See par. 46.01
22.28	Constant speed 3	Defines constant speed 3.	0.00 rpm
	-30000.00 ... 30000.00 rpm	Constant speed 3.	See par. 46.01
22.29	Constant speed 4	Defines constant speed 4.	0.00 rpm
	-30000.00 ... 30000.00 rpm	Constant speed 4.	See par. 46.01
22.30	Constant speed 5	Defines constant speed 5.	0.00 rpm
	-30000.00 ... 30000.00 rpm	Constant speed 5.	See par. 46.01

No.	Name/Value	Description	Def/FbEq16
22.31	Constant speed 6	Defines constant speed 6.	0.00 rpm
	-30000.00 ... 30000.00 rpm	Constant speed 6.	See par. 46.01
22.32	Constant speed 7	Defines constant speed 7.	0.00 rpm
	-30000.00 ... 30000.00 rpm	Constant speed 7.	See par. 46.01
22.41	Speed ref safe	Defines a safe speed reference value that is used with supervision functions such as <ul style="list-style-type: none"> • 12.03 AI supervision function • 49.05 Communication loss action • 50.02 FBA A comm loss func • 50.32 FBA B comm loss func • 58.14 Communication loss action. 	0.00 rpm
	-30000.00 ... 30000.00 rpm	Safe speed reference.	See par. 46.01
22.42	Jogging 1 ref	Defines the speed reference for jogging function 1. For more information on jogging, see page 57 .	0.00 rpm
	-30000.00 ... 30000.00 rpm	Speed reference for jogging function 1.	See par. 46.01
22.43	Jogging 2 ref	Defines the speed reference for jogging function 2. For more information on jogging, see page 57 .	0.00 rpm
	-30000.00 ... 30000.00 rpm	Speed reference for jogging function 2.	See par. 46.01
22.51	Critical speed function	Enables/disables the critical speeds function. Also determines whether the specified ranges are effective in both rotating directions or not. See also section Critical speeds/frequencies (page 46).	0000b

Bit	Name	Information
0	Enable	1 = Enable: Critical speeds enabled.
		0 = Disable: Critical speeds disabled.
1	Sign mode	1 = Signed: The signs of parameters 22.52...22.57 are taken into account.
		0 = Absolute: Parameters 22.52...22.57 are handled as absolute values. Each range is effective in both directions of rotation.
2...15	Reserved	

0000b...0011b	Critical speeds configuration word.	1 = 1
---------------	-------------------------------------	-------

No.	Name/Value	Description	Def/FbEq16
22.52	<i>Critical speed 1 low</i>	Defines the low limit for critical speed range 1. Note: This value must be less than or equal to the value of 22.53 Critical speed 1 high .	0.00 rpm
	-30000.00 ... 30000.00 rpm	Low limit for critical speed 1.	See par. 46.01
22.53	<i>Critical speed 1 high</i>	Defines the high limit for critical speed range 1. Note: This value must be greater than or equal to the value of 22.52 Critical speed 1 low .	0.00 rpm
	-30000.00 ... 30000.00 rpm	High limit for critical speed 1.	See par. 46.01
22.54	<i>Critical speed 2 low</i>	Defines the low limit for critical speed range 2. Note: This value must be less than or equal to the value of 22.55 Critical speed 2 high .	0.00 rpm
	-30000.00 ... 30000.00 rpm	Low limit for critical speed 2.	See par. 46.01
22.55	<i>Critical speed 2 high</i>	Defines the high limit for critical speed range 2. Note: This value must be greater than or equal to the value of 22.54 Critical speed 2 low .	0.00 rpm
	-30000.00 ... 30000.00 rpm	High limit for critical speed 2.	See par. 46.01
22.56	<i>Critical speed 3 low</i>	Defines the low limit for critical speed range 3. Note: This value must be less than or equal to the value of 22.57 Critical speed 3 high .	0.00 rpm
	-30000.00 ... 30000.00 rpm	Low limit for critical speed 3.	See par. 46.01
22.57	<i>Critical speed 3 high</i>	Defines the high limit for critical speed range 3. Note: This value must be greater than or equal to the value of 22.56 Critical speed 3 low .	0.00 rpm
	-30000.00 ... 30000.00 rpm	High limit for critical speed 3.	See par. 46.01
22.71	<i>Motor potentiometer function</i>	Activates and selects the mode of the motor potentiometer. See section Motor potentiometer (page 67).	<i>Disabled</i>
	Disabled	Motor potentiometer is disabled and its value set to 0.	0

No.	Name/Value	Description	Def/FbEq16
	Enabled (init at stop/power-up)	When enabled, the motor potentiometer first adopts the value defined by parameter 22.72 Motor potentiometer initial value . When the drive is running, the value can be adjusted from the up and down sources defined by parameters 22.73 Motor potentiometer up source and 22.74 Motor potentiometer down source . A stop or a power cycle will reset the motor potentiometer to the initial value (22.72).	1
	Enabled (resume always)	As Enabled (init at stop/power-up) , but the motor potentiometer value is retained over a stop or a power cycle.	2
22.72	Motor potentiometer initial value	Defines an initial value (starting point) for the motor potentiometer. See the selections of parameter 22.71 Motor potentiometer function .	0.00
	-32768.00 ... 32767.00	Initial value for motor potentiometer.	1 = 1
22.73	Motor potentiometer up source	Selects the source of motor potentiometer up signal. 0 = No change 1 = Increase motor potentiometer value. (If both the up and down sources are on, the potentiometer value will not change.)	Not selected
	Not selected	0.	0
	Selected	1.	1
	DI1	Digital input DI1 (10.02 DI delayed status , bit 0).	2
	DI2	Digital input DI2 (10.02 DI delayed status , bit 1).	3
	DI3	Digital input DI3 (10.02 DI delayed status , bit 2).	4
	DI4	Digital input DI4 (10.02 DI delayed status , bit 3).	5
	DI5	Digital input DI5 (10.02 DI delayed status , bit 4).	6
	DI6	Digital input DI6 (10.02 DI delayed status , bit 5).	7
	DIO1	Digital input/output DIO1 (11.02 DIO delayed status , bit 0).	10
	DIO2	Digital input/output DIO2 (11.02 DIO delayed status , bit 1).	11
	Other [bit]	Source selection (see Terms and abbreviations on page 90).	-

No.	Name/Value	Description	Def/FbEq16
22.74	<i>Motor potentiometer down source</i>	Selects the source of motor potentiometer down signal. 0 = No change 1 = Decrease motor potentiometer value. (If both the up and down sources are on, the potentiometer value will not change.) For the selections, see parameter 22.73 Motor potentiometer up source .	<i>Not selected</i>
22.75	<i>Motor potentiometer ramp time</i>	Defines the change rate of the motor potentiometer. This parameter specifies the time required for the motor potentiometer to change from minimum (22.76) to maximum (22.77). The same change rate applies in both directions.	60.0 s
	0.0 ... 3600.0 s	Motor potentiometer change time.	10 = 1 s
22.76	<i>Motor potentiometer min value</i>	Defines the minimum value of the motor potentiometer.	-1500.00
	-32768.00 ... 32767.00	Motor potentiometer minimum.	1 = 1
22.77	<i>Motor potentiometer max value</i>	Defines the maximum value of the motor potentiometer.	1500.00
	-32768.00 ... 32767.00	Motor potentiometer maximum.	1 = 1
22.80	<i>Motor potentiometer ref act</i>	Displays the output of the motor potentiometer function. (The motor potentiometer is configured using parameters 22.71...22.74 .) This parameter is read-only.	-
	-32768.00 ... 32767.00	Value of motor potentiometer.	1 = 1
22.81	<i>Speed reference act 1</i>	Displays the value of speed reference source 1 (selected by parameter 22.11 Speed ref1 source). See the control chain diagram on page 566 . This parameter is read-only.	-
	-30000.00 ... 30000.00 rpm	Value of reference source 1.	See par. 46.01
22.82	<i>Speed reference act 2</i>	Displays the value of speed reference source 2 (selected by parameter 22.12 Speed ref2 source). See the control chain diagram on page 566 . This parameter is read-only.	-
	-30000.00 ... 30000.00 rpm	Value of reference source 2.	See par. 46.01

No.	Name/Value	Description	Def/FbEq16
22.83	<i>Speed reference act 3</i>	Displays the value of speed reference after the mathematical function applied by parameter 22.13 Speed ref1 function and reference 1/2 selection (22.14 Speed ref1/2 selection). See the control chain diagram on page 566 . This parameter is read-only.	-
	-30000.00 ... 30000.00 rpm	Speed reference after source selection.	See par. 46.01
22.84	<i>Speed reference act 4</i>	Displays the value of speed reference after application of 1st speed additive (22.15 Speed additive 1 source). See the control chain diagram on page 566 . This parameter is read-only.	-
	-30000.00 ... 30000.00 rpm	Speed reference after additive 1.	See par. 46.01
22.85	<i>Speed reference act 5</i>	Displays the value of speed reference after the application of the speed share scaling factor (22.16 Speed share). See the control chain diagram on page 566 . This parameter is read-only.	-
	-30000.00 ... 30000.00 rpm	Speed reference after speed share scaling.	See par. 46.01
22.86	<i>Speed reference act 6</i>	Displays the value of speed reference after application of 2nd speed additive (22.17 Speed additive 2 source). See the control chain diagram on page 566 . This parameter is read-only.	-
	-30000.00 ... 30000.00 rpm	Speed reference after additive 2.	See par. 46.01
22.87	<i>Speed reference act 7</i>	Displays the value of speed reference before application of critical speeds. See the control chain diagram on page 567 . The value is received from 22.86 Speed reference act 6 unless overridden by <ul style="list-style-type: none"> • any constant speed • a jogging reference • <i>network control</i> reference • control panel reference • safe speed reference. This parameter is read-only.	-
	-30000.00 ... 30000.00 rpm	Speed reference before application of critical speeds.	See par. 46.01

No.	Name/Value	Description	Def/FbEq16
23	Speed reference ramp	Speed reference ramp settings (programming of the acceleration and deceleration rates for the drive). See the control chain diagram on page 568.	
23.01	Speed ref ramp input	Displays the used speed reference (in rpm) before it enters the ramping and shaping functions. See the control chain diagram on page 568. This parameter is read-only.	-
	-30000.00 ... 30000.00 rpm	Speed reference before ramping and shaping.	See par. 46.01
23.02	Speed ref ramp output	Displays the ramped and shaped speed reference in rpm. See the control chain diagram on page 568. This parameter is read-only.	-
	-30000.00 ... 30000.00 rpm	Speed reference after ramping and shaping.	See par. 46.01
23.11	Ramp set selection	Selects the source that switches between the two sets of acceleration/deceleration ramp times defined by parameters 23.12...23.15. 0 = Acceleration time 1 and deceleration time 1 are active 1 = Acceleration time 2 and deceleration time 2 are active	DI4; Acc/Dec time 2 (95.20 b1)
	Acc/Dec time 1	0.	0
	Acc/Dec time 2	1.	1
	DI1	Digital input DI1 (10.02 DI delayed status, bit 0).	2
	DI2	Digital input DI2 (10.02 DI delayed status, bit 1).	3
	DI3	Digital input DI3 (10.02 DI delayed status, bit 2).	4
	DI4	Digital input DI4 (10.02 DI delayed status, bit 3).	5
	DI5	Digital input DI5 (10.02 DI delayed status, bit 4).	6
	DI6	Digital input DI6 (10.02 DI delayed status, bit 5).	7
	DIO1	Digital input/output DIO1 (11.02 DIO delayed status, bit 0).	10
	DIO2	Digital input/output DIO2 (11.02 DIO delayed status, bit 1).	11
	Other [bit]	Source selection (see Terms and abbreviations on page 90).	-

No.	Name/Value	Description	Def/FbEq16
23.12	<i>Acceleration time 1</i>	<p>Defines acceleration time 1 as the time required for the speed to change from zero to the speed defined by parameter <i>46.01 Speed scaling</i> (not to parameter <i>30.12 Maximum speed</i>).</p> <p>If the speed reference increases faster than the set acceleration rate, the motor speed will follow the acceleration rate.</p> <p>If the speed reference increases slower than the set acceleration rate, the motor speed will follow the reference.</p> <p>If the acceleration time is set too short, the drive will automatically prolong the acceleration in order not to exceed the drive torque limits.</p>	20.000 s
	0.000 ... 1800.000 s	Acceleration time 1.	10 = 1 s
23.13	<i>Deceleration time 1</i>	<p>Defines deceleration time 1 as the time required for the speed to change from the speed defined by parameter <i>46.01 Speed scaling</i> (not from parameter <i>30.12 Maximum speed</i>) to zero.</p> <p>If the speed reference decreases slower than the set deceleration rate, the motor speed will follow the reference.</p> <p>If the reference changes faster than the set deceleration rate, the motor speed will follow the deceleration rate.</p> <p>If the deceleration rate is set too short, the drive will automatically prolong the deceleration in order not to exceed drive torque limits (or not to exceed a safe DC link voltage). If there is any doubt about the deceleration time being too short, ensure that DC overvoltage control is on (parameter <i>30.30 Overvoltage control</i>).</p> <p>Note: If a short deceleration time is needed for a high inertia application, the drive should be equipped with braking equipment such as a brake chopper and brake resistor.</p>	20.000 s
	0.000 ... 1800.000 s	Deceleration time 1.	10 = 1 s
23.14	<i>Acceleration time 2</i>	Defines acceleration time 2. See parameter <i>23.12 Acceleration time 1</i> .	60.000 s
	0.000 ... 1800.000 s	Acceleration time 2.	10 = 1 s

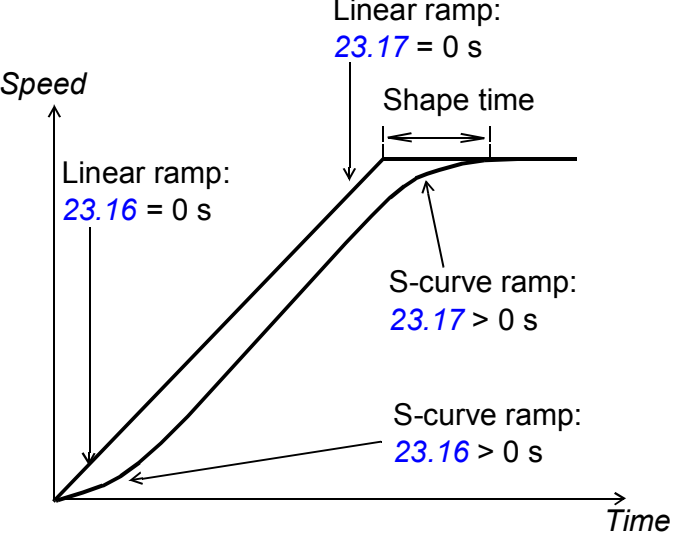
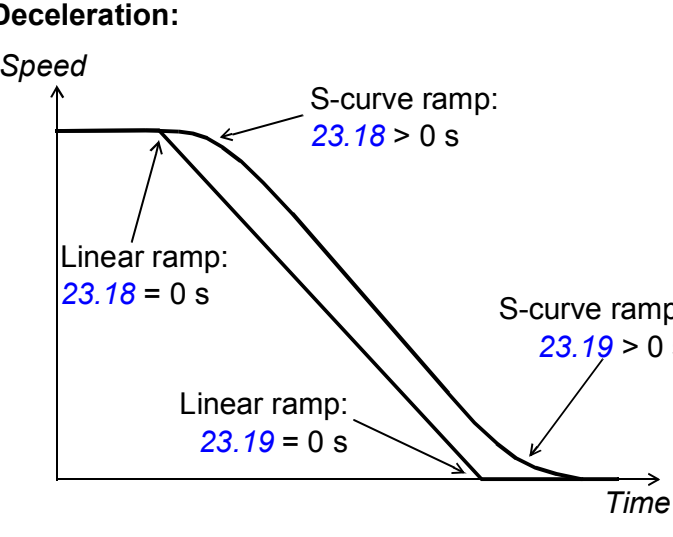
No.	Name/Value	Description	Def/FbEq16
23.15	<i>Deceleration time 2</i>	Defines deceleration time 2. See parameter 23.13 Deceleration time 1 .	60.000 s
	0.000 ... 1800.000 s	Deceleration time 2.	10 = 1 s
23.16	<i>Shape time acc 1</i>	<p>Defines the shape of the acceleration ramp at the beginning of the acceleration.</p> <p>0.000 s: Linear ramp. Suitable for steady acceleration or deceleration and for slow ramps.</p> <p>0.001...1000.000 s: S-curve ramp. S-curve ramps are ideal for lifting applications. The S-curve consists of symmetrical curves at both ends of the ramp and a linear part in between.</p> <p>Note: For safety reasons, shape times are not applied to emergency stop ramps.</p> <p>Acceleration:</p>  <p>Deceleration:</p> 	0.000 s
	0.000 ... 1800.000 s	Ramp shape at start of acceleration.	10 = 1 s

212 Parameters

No.	Name/Value	Description	Def/FbEq16
23.17	<i>Shape time acc 2</i>	Defines the shape of the acceleration ramp at the end of the acceleration. See parameter 23.16 Shape time acc 1 .	0.000 s
	0.000 ... 1800.000 s	Ramp shape at end of acceleration.	10 = 1 s
23.18	<i>Shape time dec 1</i>	Defines the shape of the deceleration ramp at the beginning of the deceleration. See parameter 23.16 Shape time acc 1 .	0.000 s
	0.000 ... 1800.000 s	Ramp shape at start of deceleration.	10 = 1 s
23.19	<i>Shape time dec 2</i>	Defines the shape of the deceleration ramp at the end of the deceleration. See parameter 23.16 Shape time acc 1 .	0.000 s
	0.000 ... 1800.000 s	Ramp shape at end of deceleration.	10 = 1 s
23.20	<i>Acc time jogging</i>	Defines the acceleration time for the jogging function i.e. the time required for the speed to change from zero to the speed value defined by parameter 46.01 Speed scaling . See section Jogging (page 57).	60.000 s
	0.000 ... 1800.000 s	Acceleration time for jogging.	10 = 1 s
23.21	<i>Dec time jogging</i>	Defines the deceleration time for the jogging function i.e. the time required for the speed to change from the speed value defined by parameter 46.01 Speed scaling to zero. See section Jogging (page 57).	60.000 s
	0.000 ... 1800.000 s	Deceleration time for jogging.	10 = 1 s

No.	Name/Value	Description	Def/FbEq16
23.23	<i>Emergency stop time</i>	<p>In speed control mode, this parameter defines the deceleration rate for emergency stop Off3 as the time it would take for the speed to decrease from the value of parameter 46.01 Speed scaling to zero. This also applies to torque control because the drive switches to speed control on receiving an emergency stop Off3 command.</p> <p>In frequency control mode, this parameter specifies the time it would take for the frequency to decrease from the value of 46.02 Frequency scaling to zero.</p> <p>The emergency stop mode and activation source are selected by parameters 21.04 Emergency stop mode and 21.05 Emergency stop source respectively. Emergency stop can also be activated through fieldbus.</p> <p>Note: Emergency stop Off1 uses the standard deceleration ramp as defined by parameters 23.11...23.19 (speed and torque control) or 28.71...28.75 (frequency control).</p>	3.000 s
	0.000 ... 1800.000 s	Emergency stop Off3 deceleration time.	10 = 1 s
23.24	<i>Speed ramp in zero source</i>	<p>Selects a source that forces the speed reference to zero just before it enters the ramp function.</p> <p>0 = Force speed reference to zero before the ramp function 1 = Speed reference continues towards the ramp function as normal</p>	<i>Inactive</i>
	Active	0.	0
	Inactive	1.	1
	DI1	Digital input DI1 (10.02 DI delayed status , bit 0).	2
	DI2	Digital input DI2 (10.02 DI delayed status , bit 1).	3
	DI3	Digital input DI3 (10.02 DI delayed status , bit 2).	4
	DI4	Digital input DI4 (10.02 DI delayed status , bit 3).	5
	DI5	Digital input DI5 (10.02 DI delayed status , bit 4).	6
	DI6	Digital input DI6 (10.02 DI delayed status , bit 5).	7
	DIO1	Digital input/output DIO1 (11.02 DIO delayed status , bit 0).	10
	DIO2	Digital input/output DIO2 (11.02 DIO delayed status , bit 1).	11
	<i>Other [bit]</i>	Source selection (see Terms and abbreviations on page 90).	-

No.	Name/Value	Description	Def/FbEq16
23.26	<i>Ramp out balancing enable</i>	<p>Selects the source for enabling/disabling speed reference ramp balancing.</p> <p>This function is used to generate a smooth transfer from a torque- or tension-controlled motor back to being speed-controlled. The balancing output would be tracking the present “line” speed of the application and when transfer is required, the speed reference can then be quickly “seeded” to the correct line speed. Balancing is also possible in the speed controller, see parameter 25.09 Speed ctrl balancing enable.</p> <p>See also parameter 23.27 Ramp out balancing ref.</p> <p>0 = Disabled 1 = Enabled</p>	<i>Not selected</i>
	Not selected	0.	0
	Selected	1.	1
	DI1	Digital input DI1 (10.02 DI delayed status , bit 0).	2
	DI2	Digital input DI2 (10.02 DI delayed status , bit 1).	3
	DI3	Digital input DI3 (10.02 DI delayed status , bit 2).	4
	DI4	Digital input DI4 (10.02 DI delayed status , bit 3).	5
	DI5	Digital input DI5 (10.02 DI delayed status , bit 4).	6
	DI6	Digital input DI6 (10.02 DI delayed status , bit 5).	7
	DIO1	Digital input/output DIO1 (11.02 DIO delayed status , bit 0).	10
	DIO2	Digital input/output DIO2 (11.02 DIO delayed status , bit 1).	11
	<i>Other [bit]</i>	Source selection (see Terms and abbreviations on page 90).	-
23.27	<i>Ramp out balancing ref</i>	<p>Defines the reference for speed ramp balancing. The output of the ramp generator is forced to this value when balancing is enabled by parameter 23.26 Ramp out balancing enable.</p>	0.00 rpm
	-30000.00 ... 30000.00 rpm	Speed ramp balancing reference.	See par. 46.01

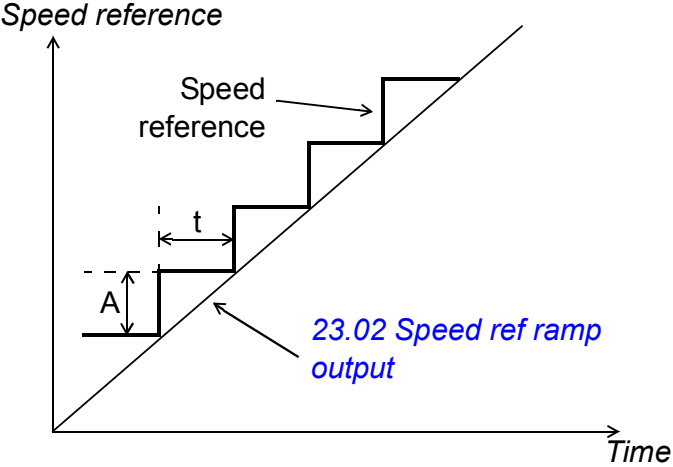
No.	Name/Value	Description	Def/FbEq16
23.28	<i>Variable slope enable</i>	<p>Activates the variable slope function, which controls the slope of the speed ramp during a speed reference change. This allows for a constantly variable ramp rate to be generated, instead of just the standard two ramps normally available.</p> <p>If the update interval of the signal from an external control system and the variable slope rate (23.29 <i>Variable slope rate</i>) are equal, the resulting speed reference (23.02 <i>Speed ref ramp output</i>) is a straight line.</p>  <p><i>t</i> = update interval of signal from external control system <i>A</i> = speed reference change during <i>t</i></p> <p>This function is only active in remote control.</p>	<i>Off</i>
	Off	Variable slope disabled.	0
	On	Variable slope enabled (not available in local control).	1
	<i>Other [bit]</i>	Source selection (see <i>Terms and abbreviations</i> on page 90).	-
23.29	<i>Variable slope rate</i>	<p>Defines the rate of the speed reference change when variable slope is enabled by parameter 23.28 <i>Variable slope enable</i>.</p> <p>For the best result, enter the reference update interval into this parameter.</p>	50 ms
	2...30000 ms	Variable slope rate.	1 = 1 ms
23.39	<i>Follower speed correction out</i>	<p>Displays the speed correction term for the load share function with a speed-controlled follower drive.</p> <p>See section <i>Load share function with a speed-controlled follower</i> (page 40).</p> <p>This parameter is read-only.</p>	-
	-30000.00 ... 30000.00 rpm	Speed correction term.	See par. 46.01

No.	Name/Value	Description	Def/FbEq16
23.40	<i>Follower speed correction enable</i>	With a speed-controlled follower, selects the source for enabling/disabling the load share function. See section <i>Load share function with a speed-controlled follower</i> (page 40). 0 = Disabled 1 = Enabled	<i>Not selected</i>
	Not selected	0.	0
	Selected	1.	1
	DI1	Digital input DI1 (<i>10.02 DI delayed status</i> , bit 0).	2
	DI2	Digital input DI2 (<i>10.02 DI delayed status</i> , bit 1).	3
	DI3	Digital input DI3 (<i>10.02 DI delayed status</i> , bit 2).	4
	DI4	Digital input DI4 (<i>10.02 DI delayed status</i> , bit 3).	5
	DI5	Digital input DI5 (<i>10.02 DI delayed status</i> , bit 4).	6
	DI6	Digital input DI6 (<i>10.02 DI delayed status</i> , bit 5).	7
	DIO1	Digital input/output DIO1 (<i>11.02 DIO delayed status</i> , bit 0).	10
	DIO2	Digital input/output DIO2 (<i>11.02 DIO delayed status</i> , bit 1).	11
	<i>Other [bit]</i>	Source selection (see <i>Terms and abbreviations</i> on page 90).	-
23.41	<i>Follower speed correction gain</i>	Adjusts the gain of the speed correction term in a speed-controlled follower. In effect, defines how accurately the follower follows the master torque. A greater value results in a more accurate performance. See section <i>Load share function with a speed-controlled follower</i> (page 40).	1.00%
	0.00 ... 100.00%	Speed correction term adjustment.	1 = 1%
23.42	<i>Follower speed corr torq source</i>	Selects the source of the torque reference for the load share function. See section <i>Load share function with a speed-controlled follower</i> (page 40).	<i>MF ref 2</i>
	NULL	None.	0
	MF ref 2	<i>03.14 M/F or D2D ref2</i> (page 99).	1
	<i>Other</i>	Source selection (see <i>Terms and abbreviations</i> on page 90).	-

No.	Name/Value	Description	Def/FbEq16
24 Speed reference conditioning		Speed error calculation; speed error window control configuration; speed error step. See the control chain diagrams on pages 571 and 572.	
24.01	<i>Used speed reference</i>	Displays the ramped and corrected speed reference (before speed error calculation). See the control chain diagram on page 571. This parameter is read-only.	-
	-30000.00 ... 30000.00 rpm	Speed reference used for speed error calculation.	See par. 46.01
24.02	<i>Used speed feedback</i>	Displays the speed feedback used for speed error calculation. See the control chain diagram on page 571. This parameter is read-only.	-
	-30000.00 ... 30000.00 rpm	Speed feedback used for speed error calculation.	See par. 46.01
24.03	<i>Speed error filtered</i>	Displays the filtered speed error. See the control chain diagram on page 571. This parameter is read-only.	-
	-30000.0 ... 30000.0 rpm	Filtered speed error.	See par. 46.01
24.04	<i>Speed error inverted</i>	Displays the inverted (unfiltered) speed error. See the control chain diagram on page 571. This parameter is read-only.	-
	-30000.0 ... 30000.0 rpm	Inverted speed error.	See par. 46.01
24.11	<i>Speed correction</i>	Defines a speed reference correction, ie. a value added to the existing reference between ramping and limitation. This is useful to trim the speed if necessary, for example to adjust draw between sections of a paper machine. Note: For safety reasons, the correction is not applied when an emergency stop is active.  WARNING! If the speed reference correction exceeds 21.06 Zero speed limit, a ramp stop may be impossible. Make sure the correction is reduced or removed when a ramp stop is required. See the control chain diagram on page 571.	0.00 rpm
	-10000.00 ... 10000.00 rpm	Speed reference correction.	See par. 46.01

No.	Name/Value	Description	Def/FbEq16
24.12	<i>Speed error filter time</i>	<p>Defines the time constant of the speed error low-pass filter.</p> <p>If the used speed reference changes rapidly, the possible interferences in the speed measurement can be filtered with the speed error filter. Reducing the ripple with this filter may cause speed controller tuning problems. A long filter time constant and fast acceleration time contradict one another. A very long filter time results in unstable control.</p>	0 ms
	0...10000 ms	Speed error filtering time constant. 0 = filtering disabled.	1 = 1 ms
24.41	<i>Speed error window control enable</i>	<p>Enables/disables (or selects a source that enables/disables) speed error window control, sometimes also referred to as deadband control or strip break protection. It forms a speed supervision function for a torque-controlled drive, preventing the motor from running away if the material that is being held under tension breaks.</p> <p>Note: Speed error window control is only effective when the <i>Add</i> operating mode is active (see parameters 19.12 and 19.14), or when the drive is a speed-controlled follower (see page 40).</p> <p>In normal operation, window control keeps the speed controller input at zero so the drive stays in torque control.</p> <p>If the motor load is lost, then the motor speed will rise as the torque controller tries to maintain torque. The speed error (speed reference - actual speed) will increase until it exits the speed error window. When this is detected, the exceeding part of the error value is connected to the speed controller. The speed controller produces a reference term relative to the input and gain (25.02 Speed proportional gain) which the torque selector adds to the torque reference. The result is used as the internal torque reference for the drive.</p> <p>The activation of speed error window control is indicated by bit 3 of 06.19 Speed control status word.</p>	<i>Disable</i>

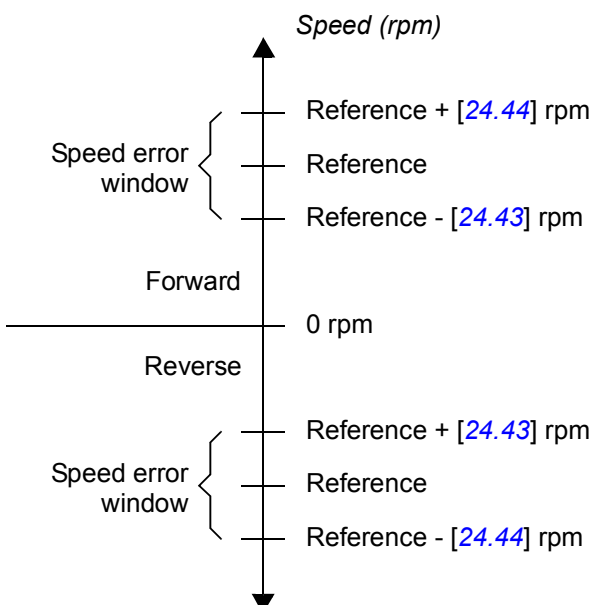
No.	Name/Value	Description	Def/FbEq16
		<p>The window boundaries are defined by 24.43 Speed error window high and 24.44 Speed error window low as follows:</p>  <p>Note that it is parameter 24.44 (rather than 24.43) that defines the overspeed limit in both directions of rotation. This is because the function monitors speed error (which is negative in case of overspeed, positive in case of underspeed).</p> <p>0 = Speed error window control disabled 1 = Speed error window control enabled</p>	
	Disable	0.	0
	Enable	1.	1
	<i>Other [bit]</i>	Source selection (see Terms and abbreviations on page 90).	-
24.42	Speed window control mode	When speed error window control (see parameter 24.41 Speed error window control enable) is enabled, this parameter determines whether the speed controller only observes the proportional term instead of all three (P, I and D) terms.	<i>Normal speed control</i>
	Normal speed control	All three terms (parameters 25.02 , 25.03 and 25.04) are observed by the speed controller.	0
	P-control	Only the proportional term (25.02) is observed by the speed controller. The integral and derivative terms are internally forced to zero.	1
24.43	Speed error window high	Defines the upper boundary of the speed error window. See parameter 24.41 Speed error window control enable .	0.00 rpm
	0.00 ... 3000.00 rpm	Upper boundary of speed error window.	See par. 46.01

No.	Name/Value	Description	Def/FbEq16
24.44	<i>Speed error window low</i>	Defines the lower boundary of the speed error window. See parameter 24.41 Speed error window control enable .	0.00 rpm
	0.00 ... 3000.00 rpm	Lower boundary of speed error window.	See par. 46.01
24.46	<i>Speed error step</i>	Defines an additional speed error step given to the input of the speed controller (and added to the speed error value). This can be used in large drive systems for dynamic speed normalizing.  WARNING! Make sure the error step value is removed when a stop command is given.	0.00 rpm
	-3000.00 ... 3000.00 rpm	Speed error step.	See par. 46.01
25 Speed control		Speed controller settings. See the control chain diagrams on pages 571 and 572 .	
25.01	<i>Torque reference speed control</i>	Displays the speed controller output that is transferred to the torque controller. See the control chain diagram on page 572 . This parameter is read-only.	-
	-1600.0 ... 1600.0%	Limited speed controller output torque.	See par. 46.03

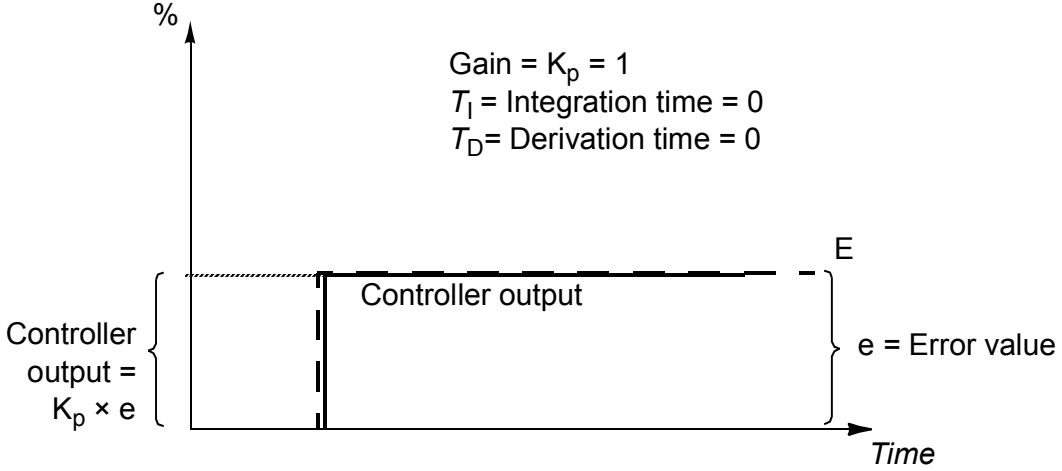
No.	Name/Value	Description	Def/FbEq16
25.02	<i>Speed proportional gain</i>	<p>Defines the proportional gain (K_p) of the speed controller. Too high a gain may cause speed oscillation. The figure below shows the speed controller output after an error step when the error remains constant.</p> 	10.00
		<p>If gain is set to 1, a 10% change in error value (reference - actual value) causes the speed controller output to change by 10%, ie. the output value is input \times gain.</p> <p>Note: This parameter is automatically set by the speed controller autotune function. See section Speed controller autotune (page 47).</p>	
	0.00 ...250.00	Proportional gain for speed controller.	100 = 1

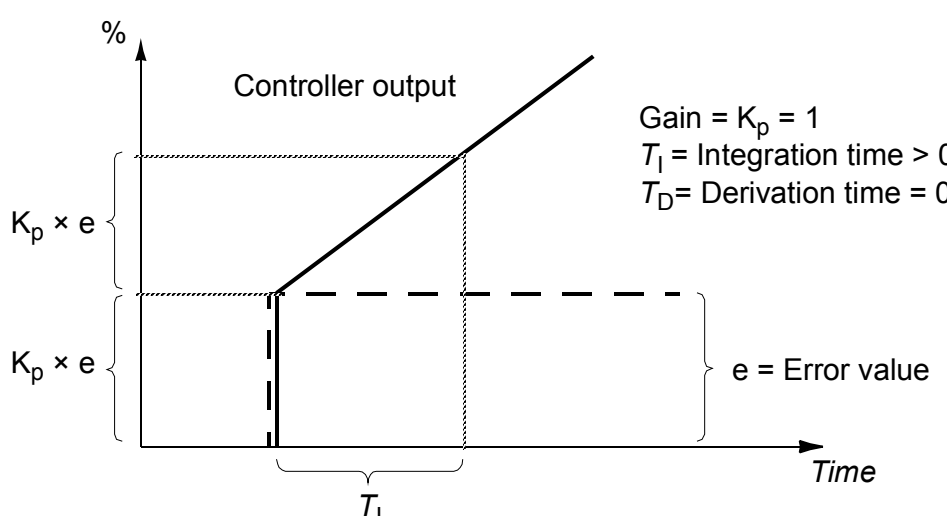
No.	Name/Value	Description	Def/FbEq16
25.03	<i>Speed integration time</i>	<p>Defines the integration time of the speed controller. The integration time defines the rate at which the controller output changes when the error value is constant and the proportional gain of the speed controller is 1. The shorter the integration time, the faster the continuous error value is corrected. This time constant must be set to the same order of magnitude as the time constant (time to respond) of the actual mechanical system being controlled, otherwise instability will result.</p> <p>Setting the integration time to zero disables the I-part of the controller. This is useful to do when tuning the proportional gain; adjust the proportional gain first, then return the integration time.</p> <p>Anti-windup (the integrator just integrates up to 100%) stops the integrator if the controller output is limited.</p> <p>The figure below shows the speed controller output after an error step when the error remains constant.</p>  <p>Note: This parameter is automatically set by the speed controller autotune function. See section Speed controller autotune (page 47).</p>	2.50 s
	0.00 ... 1000.00 s	Integration time for speed controller.	10 = 1 s

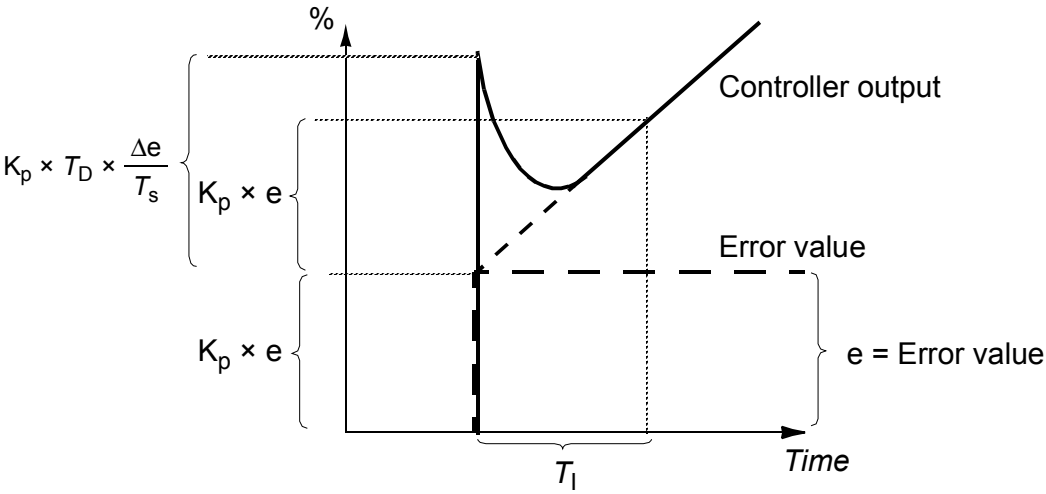
No.	Name/Value	Description	Def/FbEq16
25.04	<i>Speed derivation time</i>	<p>Defines the derivation time of the speed controller. Derivative action boosts the controller output if the error value changes. The longer the derivation time, the more the speed controller output is boosted during the change. If the derivation time is set to zero, the controller works as a PI controller, otherwise as a PID controller. The derivation makes the control more responsive for disturbances. For simple applications (especially those without a pulse encoder), derivative time is not normally required and should be left at zero.</p> <p>The speed error derivative must be filtered with a low pass filter to eliminate disturbances.</p> <p>The figure below shows the speed controller output after an error step when the error remains constant.</p>	0.000 s
<div style="text-align: center;">  <p style="text-align: center;">Gain = $K_p = 1$ T_1 = Integration time > 0 T_D = Derivation time > 0 T_s = Sample time period = 250 μs Δe = Error value change between two samples</p> </div>			
	0.000 ... 10.000 s	Derivation time for speed controller.	1000 = 1 s
25.05	<i>Derivation filter time</i>	Defines the derivation filter time constant. See parameter 25.04 Speed derivation time .	8 ms
	0...10000 ms	Derivation filter time constant.	1 = 1 ms

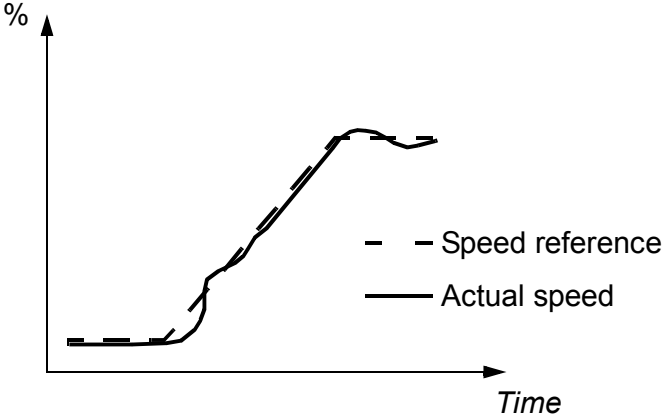
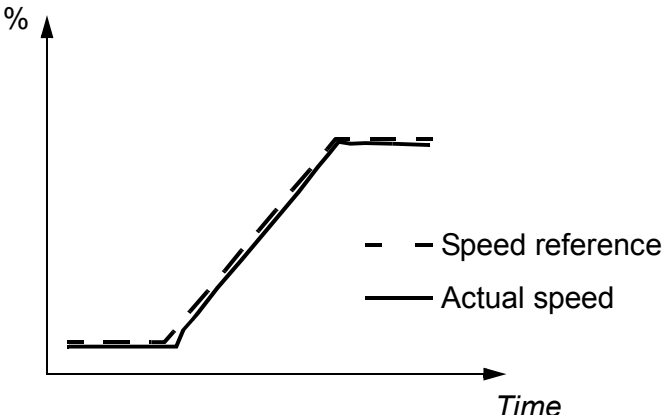
No.	Name/Value	Description	Def/FbEq16
25.06	<i>Acc comp derivation time</i>	<p>Defines the derivation time for acceleration(/deceleration) compensation. In order to compensate for a high inertia load during acceleration, a derivative of the reference is added to the output of the speed controller. The principle of a derivative action is described under parameter 25.04 Speed derivation time.</p> <p>Note: As a general rule, set this parameter to the value between 50 and 100% of the sum of the mechanical time constants of the motor and the driven machine.</p> <p>The figure below shows the speed responses when a high inertia load is accelerated along a ramp.</p> <p>No acceleration compensation:</p>  <p>Acceleration compensation:</p> 	0.00 s
	0.00 ... 1000.00 s	Acceleration compensation derivation time.	10 = 1 s

No.	Name/Value	Description	Def/FbEq16
25.07	<i>Acc comp filter time</i>	Defines the acceleration (or deceleration) compensation filter time constant.. See parameters 25.04 Speed derivation time and 25.06 Acc comp derivation time .	8.0 ms
	0.0 ... 1000.0 ms	Acceleration/deceleration compensation filter time.	1 = 1 ms
25.08	<i>Drooping rate</i>	<p>Defines the droop rate in percent of the nominal motor speed. Drooping decreases the drive speed slightly as the drive load increases. The actual speed decrease at a certain operating point depends on the droop rate setting and the drive load (= torque reference / speed controller output). At 100% speed controller output, drooping is at its nominal level, i.e. equal to the value of this parameter. The drooping effect decreases linearly to zero along with the decreasing load.</p> <p>The droop rate can be used e.g. to adjust the load sharing in a Master/Follower application run by several drives. In a Master/Follower application the motor shafts are coupled to each other.</p> <p>The correct droop rate for a process must be found out case by case in practice.</p>	0.00%
<p>Speed decrease = Speed controller output × Drooping × Nominal speed</p> <p>Example: Speed controller output is 50%, droop rate is 1%, nominal speed of the drive is 1500 rpm. Speed decrease = 0.50 × 0.01 × 1500 rpm = 7.5 rpm.</p>			
	0.00 ... 100.00%	Droop rate.	100 = 1%

No.	Name/Value	Description	Def/FbEq16
25.09	<i>Speed ctrl balancing enable</i>	Selects the source for enabling/disabling speed controller output balancing. This function is used to generate a smooth, “bumpless” transfer from a torque- or tension-controlled motor back to being speed-controlled. When balancing is enabled, the output of the speed controller is forced to the value of 25.10 Speed ctrl balancing ref . Balancing is also possible in the ramp generator (see parameter 23.26 Ramp out balancing enable). 0 = Disabled 1 = Enabled	<i>Not selected</i>
	Not selected	0.	1
	Selected	1.	2
	DI1	Digital input DI1 (10.02 DI delayed status , bit 0).	2
	DI2	Digital input DI2 (10.02 DI delayed status , bit 1).	3
	DI3	Digital input DI3 (10.02 DI delayed status , bit 2).	4
	DI4	Digital input DI4 (10.02 DI delayed status , bit 3).	5
	DI5	Digital input DI5 (10.02 DI delayed status , bit 4).	6
	DI6	Digital input DI6 (10.02 DI delayed status , bit 5).	7
	DIO1	Digital input/output DIO1 (11.02 DIO delayed status , bit 0).	10
	DIO2	Digital input/output DIO2 (11.02 DIO delayed status , bit 1).	11
	<i>Other [bit]</i>	Source selection (see Terms and abbreviations on page 90).	-
25.10	<i>Speed ctrl balancing ref</i>	Defines the reference used in speed controller output balancing. The output of the speed controller is forced to this value when balancing is enabled by parameter 25.09 Speed ctrl balancing enable .	0.0%
	-300.0 ... 300.0%	Speed control output balancing reference.	See par. 46.03
25.11	<i>Speed control min torque</i>	Defines the minimum speed controller output torque.	-300.0%
	-1600.0 ... 0.0%	Minimum speed controller output torque.	See par. 46.03
25.12	<i>Speed control max torque</i>	Defines the maximum speed controller output torque.	300.0%
	0.0 ... 1600.0%	Maximum speed controller output torque.	See par. 46.03

No.	Name/Value	Description	Def/FbEq16
25.13	<i>Min torq sp ctrl em stop</i>	Defines the minimum speed controller output torque during a ramped emergency stop (Off1 or Off3).	-400.0%
	-1600.0 ... 0.0%	Minimum speed controller output torque for ramped emergency stop.	See par. 46.03
25.14	<i>Max torq sp ctrl em stop</i>	Defines the maximum speed controller output torque during a ramped emergency stop (Off1 or Off3).	400.0%
	0.0 ... 1600.0%	Maximum speed controller output torque for ramped emergency stop.	See par. 46.03
25.15	<i>Proportional gain em stop</i>	Defines the proportional gain for the speed controller when an emergency stop is active. See parameter 25.02 Speed proportional gain .	10.00
	1.00 ... 250.00	Proportional gain upon an emergency stop.	100 = 1

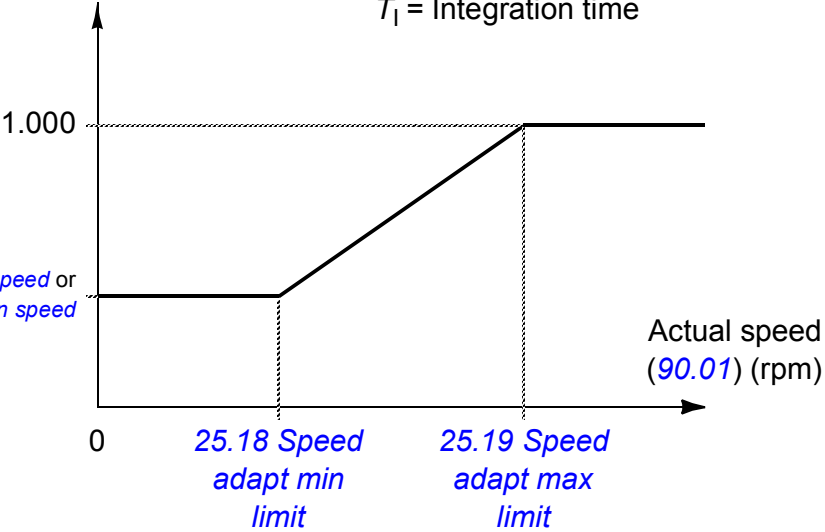
No.	Name/Value	Description	Def/FbEq16
25.18	<i>Speed adapt min limit</i>	<p>Minimum actual speed for speed controller adaptation.</p> <p>Speed controller gain and integration time can be adapted according to actual speed (90.01 Motor speed for control). This is done by multiplying the gain (25.02 Speed proportional gain) and integration time (25.03 Speed integration time) by coefficients at certain speeds. The coefficients are defined individually for both gain and integration time.</p> <p>When actual speed is below or equal to 25.18 Speed adapt min limit, the gain and integration time are multiplied by 25.21 Kp adapt coef at min speed and 25.22 Ti adapt coef at min speed respectively.</p> <p>When actual speed is equal to or above 25.19 Speed adapt max limit, no adaptation takes place (the coefficient is 1).</p> <p>When actual speed is between 25.18 Speed adapt min limit and 25.19 Speed adapt max limit, the coefficients for the gain and integration time are calculated linearly on the basis of the breakpoints.</p> <p>See also the block diagram on page 572.</p>	0 rpm
<p>Coefficient for K_p or T_i K_p = Proportional gain T_i = Integration time</p>  <p>The graph plots the coefficient for K_p or T_i on the y-axis against actual speed in rpm on the x-axis. The y-axis has a mark at 1.000. The x-axis has marks at 0, 25.18 (Speed adapt min limit), and 25.19 (Speed adapt max limit). The coefficient is constant at a value below 1.000 from 0 to 25.18 rpm. It then increases linearly to 1.000 at 25.19 rpm and remains constant at 1.000 for higher speeds. A label points to the constant part: '25.21 Kp adapt coef at min speed or 25.22 Ti adapt coef at min speed'.</p>			
	0...30000 rpm	Minimum actual speed for speed controller adaptation.	1 = 1 rpm
25.19	<i>Speed adapt max limit</i>	<p>Maximum actual speed for speed controller adaptation.</p> <p>See parameter 25.18 Speed adapt min limit.</p>	0 rpm
	0...30000 rpm	Maximum actual speed for speed controller adaptation.	1 = 1 rpm

No.	Name/Value	Description	<i>Def/FbEq16</i>
25.21	<i>Kp adapt coef at min speed</i>	Proportional gain coefficient at minimum actual speed. See parameter <i>25.18 Speed adapt min limit</i> .	1.000
	0.000 ... 10.000	Proportional gain coefficient at minimum actual speed.	1000 = 1
25.22	<i>Ti adapt coef at min speed</i>	Integration time coefficient at minimum actual speed. See parameter <i>25.18 Speed adapt min limit</i> .	1.000
	0.000 ... 10.000	Integration time coefficient at minimum actual speed.	1000 = 1

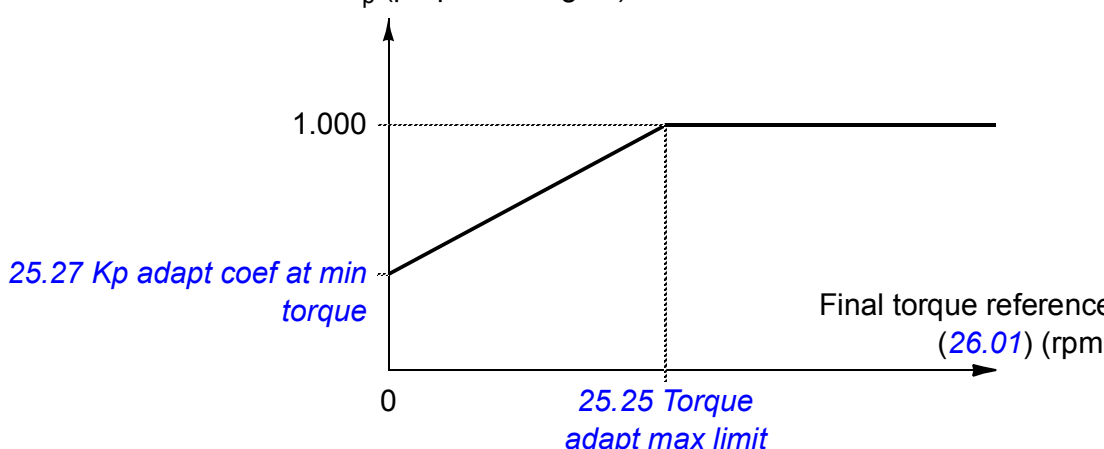
No.	Name/Value	Description	Def/FbEq16
25.25	<i>Torque adapt max limit</i>	<p>Maximum torque reference for speed controller adaptation.</p> <p>Speed controller gain can be adapted according to the final unlimited torque reference (26.01 Torque reference to TC). This can be used to smooth out disturbances caused by a small load and backlashes.</p> <p>The functionality involves multiplying the gain (25.02 Speed proportional gain) by a coefficient within a certain torque range.</p> <p>When the torque reference is 0%, the gain is multiplied by the value of parameter 25.27 Kp adapt coef at min torque.</p> <p>When the torque reference is equal to or above 25.25 Torque adapt max limit, no adaptation takes place (the coefficient is 1).</p> <p>Between 0% and 25.25 Torque adapt max limit, the coefficient for the gain is calculated linearly on the basis of the breakpoints.</p> <p>Filtering can be applied on the torque reference using parameter 25.26 Torque adapt filt time.</p> <p>See also the block diagram on page 572.</p>	0.0%
<p>Coefficient for K_p (proportional gain)</p> 			
	0.0 ... 1600.0%	Maximum torque reference for speed controller adaptation.	See par. 46.03
25.26	<i>Torque adapt filt time</i>	<p>Defines a filter time constant for the adaptation, in effect adjusting the rate of change of the gain.</p> <p>See parameter 25.25 Torque adapt max limit.</p>	0.000 s
	0.000 ... 100.000 s	Filter time for adaptation.	100 = 1 s

No.	Name/Value	Description	Def/FbEq16
25.27	<i>K_p adapt coef at min torque</i>	Proportional gain coefficient at 0% torque reference. See parameter 25.25 Torque adapt max limit .	1.000
	0.000 ... 10.000	Proportional gain coefficient at 0% torque reference.	1000 = 1
25.30	<i>Flux adaption enable</i>	Enables/disables speed controller adaptation based on motor flux reference (01.24 Flux actual %). The proportional gain of the speed controller is multiplied by a coefficient of 0...1 between 0...100% flux reference respectively. See also the block diagram on page 572 .	<i>Enable</i>
<p>Coefficient for K_p (proportional gain)</p> <p>The graph plots the coefficient for K_p on the y-axis (ranging from 0.000 to 1.000) against the Flux reference (01.24) (%) on the x-axis (ranging from 0 to 100). A solid line starts at the origin (0, 0.000) and rises linearly to the point (100, 1.000). From x=100, the line becomes horizontal at y=1.000. Dotted lines indicate the coordinates of the point (100, 1.000).</p>			
	Disable	Speed controller adaptation based on flux reference disabled.	0
	Enable	Speed controller adaptation based on flux reference enabled.	1

No.	Name/Value	Description	Def/FbEq16
25.33	<i>Speed controller autotune</i>	<p>Activates (or selects a source that activates) the speed controller autotune function. See section Speed controller autotune (page 47).</p> <p>The autotune automatically sets parameters 25.02 Speed proportional gain, 25.03 Speed integration time and 25.37 Mechanical time constant.</p> <p>The prerequisites for performing the autotune routine are:</p> <ul style="list-style-type: none"> • the motor identification run (ID run) has been successfully completed • the speed and torque limits (parameter group 30 Limits) have been set • speed feedback filtering (parameter group 90 Feedback selection), speed error filtering (24 Speed reference conditioning) and zero speed (21 Start/stop mode) have been set, and • the drive has been started and is running in speed control mode. <p> WARNING! The motor and machinery will run against the torque and speed limits during the autotune routine. MAKE SURE IT IS SAFE TO ACTIVATE THE AUTOTUNE FUNCTION!</p> <p>The autotune routine can be aborted by stopping the drive.</p> <p>0 -> 1 = Activate speed controller autotune</p> <p>Note: The value does not revert to 0 automatically.</p>	<i>Off</i>
	Off	0.	0
	On	1.	1
	<i>Other [bit]</i>	Source selection (see Terms and abbreviations on page 90).	-
25.34	<i>Speed controller autotune mode</i>	Defines a control preset for the speed controller autotune function. The setting affects the way the torque reference will respond to a speed reference step.	<i>Normal</i>
	Smooth	Slow but robust response.	0
	Normal	Medium setting.	1
	Tight	Fast response. May produce too high a gain value for some applications.	2

No.	Name/Value	Description	Def/FbEq16
25.37	<i>Mechanical time constant</i>	Mechanical time constant of the drive and the machinery as determined by the speed controller autotune function. The value can be adjusted manually.	-
	0.00 ... 1000.00 s	Mechanical time constant.	10 = 1 s
25.38	<i>Autotune torque step</i>	Defines an added torque value used by the autotune function. This value is scaled to motor nominal torque. Note that the torque used by the autotune function can also be limited by the torque limits (in parameter group 30 Limits) and nominal motor torque.	10.00%
	0.00 ... 100.00%	Autotune torque step.	100 = 1%
25.39	<i>Autotune speed step</i>	Defines a speed value added to the initial speed for the autotune routine. The initial speed (speed used when autotune is activated) plus the value of this parameter is the calculated maximum speed used by the autotune routine. The maximum speed can also be limited by the speed limits (in parameter group 30 Limits) and nominal motor speed. The value is scaled to motor nominal speed. Note: The motor will exceed the calculated maximum speed slightly at the end of each acceleration stage.	10.00%
	0.00 ... 100.00%	Autotune speed step.	100 = 1%
25.40	<i>Autotune repeat times</i>	Determines how many acceleration/deceleration cycles are performed during the autotune routine. Increasing the value will improve the accuracy of the autotune function, and allow the use of smaller torque or speed step values.	10
	1...10	Number of cycles during autotune routine.	1 = 1
25.53	<i>Torque prop reference</i>	Displays the output of the proportional (P) part of the speed controller. See the control chain diagram on page 572 . This parameter is read-only.	-
	-30000.0 ... 30000.0%	P-part output of speed controller.	See par. 46.03
25.54	<i>Torque integral reference</i>	Displays the output of the integral (I) part of the speed controller. See the control chain diagram on page 572 . This parameter is read-only.	-
	-30000.0 ... 30000.0%	I-part output of speed controller.	See par. 46.03

No.	Name/Value	Description	Def/FbEq16
25.55	<i>Torque deriv reference</i>	Displays the output of the derivative (D) part of the speed controller. See the control chain diagram on page 572. This parameter is read-only.	-
	-30000.0 ... 30000.0%	D-part output of speed controller.	See par. 46.03
25.56	<i>Torque acc compensation</i>	Displays the output of the acceleration compensation function. See the control chain diagram on page 572. This parameter is read-only.	-
	-30000.0 ... 30000.0%	Output of acceleration compensation function.	See par. 46.03
25.57	<i>Torque reference unbalanced</i>	Displays the acceleration-compensated output of the speed controller. See the control chain diagram on page 572. This parameter is read-only.	-
	-30000.0 ... 30000.0%	Acceleration-compensated output of speed controller.	See par. 46.03
26 Torque reference chain		Settings for the torque reference chain. See the control chain diagrams on pages 573 and 575.	
26.01	<i>Torque reference to TC</i>	Displays the final torque reference given to the torque controller in percent. This reference is then acted upon by various final limiters, like power, torque, load etc. See the control chain diagrams on pages 575 and 576. This parameter is read-only.	-
	-1600.0 ... 1600.0%	Torque reference for torque control.	See par. 46.03
26.02	<i>Torque reference used</i>	Displays the final torque reference (in percent of motor nominal torque) given to the DTC core, and comes after frequency, voltage and torque limitation. See the control chain diagram on page 576. This parameter is read-only.	-
	-1600.0 ... 1600.0%	Torque reference for torque control.	See par. 46.03

No.	Name/Value	Description	Def/FbEq16
26.08	<i>Minimum torque ref</i>	Defines the minimum torque reference. Allows for local limiting of the torque reference before it is passed on to the torque ramp controller. For absolute torque limiting, refer to parameter 30.19 Minimum torque 1 .	-300.0%
	-1000.0 ... 0.0%	Minimum torque reference.	See par. 46.03
26.09	<i>Maximum torque ref</i>	Defines the maximum torque reference. Allows for local limiting of the torque reference before it is passed on to the torque ramp controller. For absolute torque limiting, refer to parameter 30.20 Maximum torque 1 .	300.0%
	0.0 ... 1000.0%	Maximum torque reference.	See par. 46.03
26.11	<i>Torque ref1 source</i>	Selects torque reference source 1. Two signal sources can be defined by this parameter and 26.12 Torque ref2 source . A digital source selected by 26.14 Torque ref1/2 selection can be used to switch between the two sources, or a mathematical function (26.13 Torque ref1 function) applied to the two signals to create the reference.	Zero
Zero	None.	0	0
AI1 scaled	12.12 AI1 scaled value (see page 137).	1	1
AI2 scaled	12.22 AI2 scaled value (see page 140).	2	2
FB A ref1	03.05 FB A reference 1 (see page 98).	4	4
FB A ref2	03.06 FB A reference 2 (see page 98).	5	5
EFB ref1	03.09 EFB reference 1 (see page 98).	8	8
EFB ref2	03.10 EFB reference 2 (see page 99).	9	9
M/F reference 1	03.13 M/F or D2D ref1 (see page 99).	12	12

No.	Name/Value	Description	Def/FbEq16
	M/F reference 2	03.14 M/F or D2D ref2 (see page 99).	13
	Motor potentiometer	22.80 Motor potentiometer ref act (output of the motor potentiometer).	15
	PID	Reserved	16
	Control panel (ref saved)	Control panel reference, with initial value from last-used panel reference. See section Using the control panel as an external control source (page 27).	18
	Control panel (ref copied)	Control panel reference, with initial value from previous source or actual value. See section Using the control panel as an external control source (page 27).	19
	<i>Other</i>	Source selection (see Terms and abbreviations on page 90).	-
26.12	Torque ref2 source	Selects torque reference source 2. For the selections, and a diagram of reference source selection, see parameter 26.11 Torque ref1 source .	<i>Zero</i>
26.13	Torque ref1 function	Selects a mathematical function between the reference sources selected by parameters 26.11 Torque ref1 source and 26.12 Torque ref2 source . See diagram at 26.11 Torque ref1 source .	<i>Ref1</i>
	Ref1	Signal selected by 26.11 Torque ref1 source is used as torque reference 1 as such (no function applied).	0
	Add (ref1 + ref2)	The sum of the reference sources is used as torque reference 1.	1
	Sub (ref1 - ref2)	The subtraction ([26.11 Torque ref1 source] - [26.12 Torque ref2 source]) of the reference sources is used as torque reference 1.	2
	Mul (ref1 × ref2)	The multiplication of the reference sources is used as torque reference 1.	3
	Min (ref1, ref2)	The smaller of the reference sources is used as torque reference 1.	4
	Max (ref1, ref2)	The greater of the reference sources is used as torque reference 1.	5
26.14	Torque ref1/2 selection	Configures the selection between torque references 1 and 2. See diagram at 26.11 Torque ref1 source .	<i>Torque reference 1</i>
	Torque reference 1	0.	0
	Torque reference 2	1.	1

No.	Name/Value	Description	Def/FbEq16
	Follow Ext1/Ext2 selection	Torque reference 1 is used when external control location EXT1 is active. Torque reference 2 is used when external control location EXT2 is active. See also parameter 19.11 Ext1/Ext2 selection .	2
	DI1	Digital input DI1 (10.02 DI delayed status , bit 0).	3
	DI2	Digital input DI2 (10.02 DI delayed status , bit 1).	4
	DI3	Digital input DI3 (10.02 DI delayed status , bit 2).	5
	DI4	Digital input DI4 (10.02 DI delayed status , bit 3).	6
	DI5	Digital input DI5 (10.02 DI delayed status , bit 4).	7
	DI6	Digital input DI6 (10.02 DI delayed status , bit 5).	8
	<i>Other [bit]</i>	Source selection (see Terms and abbreviations on page 90).	-
26.15	Load share	Defines the scaling factor for the torque reference (the torque reference is multiplied by the value). This allows drives sharing the load between two motors on the same mechanical plant to be tailored to share the correct amount each, yet use the same master torque reference.	1.000
	-8.000 ... 8.000	Torque reference scaling factor.	1000 = 1
26.16	Torque additive 1 source	Selects the source of torque reference additive 1. Note: For safety reasons, the additive is not applied when an emergency stop is active. See the control chain diagram on page 573. For the selections, see parameter 26.11 Torque ref1 source .	Zero
26.17	Torque ref filter time	Defines a low-pass filter time constant for the torque reference.	0.000 s
	0.000 ... 30.000 s	Filter time constant for torque reference.	1000 = 1 s
26.18	Torque ramp up time	Defines the torque reference ramp-up time, ie. the time for the reference to increase from zero to nominal motor torque.	0.000 s
	0.000 ... 60.000 s	Torque reference ramp-up time.	100 = 1 s
26.19	Torque ramp down time	Defines the torque reference ramp-down time, ie. the time for the reference to decrease from nominal motor torque to zero.	0.000 s
	0.000 ... 60.000 s	Torque reference ramp-down time.	100 = 1 s

No.	Name/Value	Description	Def/FbEq16
26.25	<i>Torque additive 2 source</i>	<p>Selects the source of torque reference additive 2.</p> <p>The value received from the selected source is added to the torque reference after operating mode selection. Because of this, the additive can be used in speed and torque modes.</p> <p>Note: For safety reasons, the additive is not applied when an emergency stop is active.</p> <p> WARNING! If the additive exceeds the limits set by parameters <i>25.11 Speed control min torque</i> and <i>25.12 Speed control max torque</i>, a ramp stop may be impossible. Make sure the additive is reduced or removed when a ramp stop is required eg. by using parameter <i>26.26 Force torque ref add 2 zero</i>.</p> <p>See the control chain diagram on page 575.</p> <p>For the selections, see parameter <i>26.11 Torque ref1 source</i>.</p>	Zero
26.26	<i>Force torque ref add 2 zero</i>	<p>Selects a source that forces torque reference additive 2 (see parameter <i>26.25 Torque additive 2 source</i>) to zero.</p> <p>0 = Normal operation 1 = Force torque reference additive 2 to zero.</p>	Not selected
	Not selected	0.	0
	Selected	1.	1
	DI1	Digital input DI1 (<i>10.02 DI delayed status</i> , bit 0).	2
	DI2	Digital input DI2 (<i>10.02 DI delayed status</i> , bit 1).	3
	DI3	Digital input DI3 (<i>10.02 DI delayed status</i> , bit 2).	4
	DI4	Digital input DI4 (<i>10.02 DI delayed status</i> , bit 3).	5
	DI5	Digital input DI5 (<i>10.02 DI delayed status</i> , bit 4).	6
	DI6	Digital input DI6 (<i>10.02 DI delayed status</i> , bit 5).	7
	DIO1	Digital input/output DIO1 (<i>11.02 DIO delayed status</i> , bit 0).	10
	DIO2	Digital input/output DIO2 (<i>11.02 DIO delayed status</i> , bit 1).	11
	<i>Other [bit]</i>	Source selection (see <i>Terms and abbreviations</i> on page 90).	-

No.	Name/Value	Description	Def/FbEq16
26.41	<i>Torque step</i>	When enabled by parameter <i>26.42 Torque step enable</i> , adds an additional step to the torque reference. Note: For safety reasons, the torque step is not applied when an emergency stop is active.  WARNING! If the torque step exceeds the limits set by parameters <i>25.11 Speed control min torque</i> and <i>25.12 Speed control max torque</i> , a ramp stop may be impossible. Make sure the torque step is reduced or removed when a ramp stop is required eg. by using parameter <i>26.42 Torque step enable</i> .	0.0%
	-300.0 ... 300.0%	Torque step.	See par. <i>46.03</i>
26.42	<i>Torque step enable</i>	Enables/disables a torque step (defined by parameter <i>26.41 Torque step</i>).	<i>Disable</i>
	Disable	Torque step disabled.	0
	Enable	Torque step enabled.	1
26.51	<i>Oscillation damping</i>	Parameters <i>26.51...26.58</i> configure the oscillation damping function. See section <i>Oscillation damping</i> (page <i>50</i>), and the block diagram on page <i>575</i> . This parameter enables (or selects a source that enables) the oscillation damping algorithm. 1 = Oscillation damping algorithm enabled	<i>Not selected</i>
	Not selected	0.	0
	Selected	1.	1
	DI1	Digital input DI1 (<i>10.02 DI delayed status</i> , bit 0).	2
	DI2	Digital input DI2 (<i>10.02 DI delayed status</i> , bit 1).	3
	DI3	Digital input DI3 (<i>10.02 DI delayed status</i> , bit 2).	4
	DI4	Digital input DI4 (<i>10.02 DI delayed status</i> , bit 3).	5
	DI5	Digital input DI5 (<i>10.02 DI delayed status</i> , bit 4).	6
	DI6	Digital input DI6 (<i>10.02 DI delayed status</i> , bit 5).	7
	DIO1	Digital input/output DIO1 (<i>11.02 DIO delayed status</i> , bit 0).	10
	DIO2	Digital input/output DIO2 (<i>11.02 DIO delayed status</i> , bit 1).	11
	<i>Other [bit]</i>	Source selection (see <i>Terms and abbreviations</i> on page <i>90</i>).	-

No.	Name/Value	Description	Def/FbEq16
26.52	<i>Oscillation damping out enable</i>	Determines (or selects a source that determines) whether the output of the oscillation damping function is applied to the torque reference or not. Note: Before enabling the oscillation damping output, adjust parameters 26.53...26.57. Then monitor the input signal (selected by 26.53) and the output (26.58) to make sure that the correction is safe to apply. 1 = Apply oscillation damping output to torque reference	<i>Not selected</i>
	Not selected	0.	0
	Selected	1.	1
	DI1	Digital input DI1 (<i>10.02 DI delayed status</i> , bit 0).	2
	DI2	Digital input DI2 (<i>10.02 DI delayed status</i> , bit 1).	3
	DI3	Digital input DI3 (<i>10.02 DI delayed status</i> , bit 2).	4
	DI4	Digital input DI4 (<i>10.02 DI delayed status</i> , bit 3).	5
	DI5	Digital input DI5 (<i>10.02 DI delayed status</i> , bit 4).	6
	DI6	Digital input DI6 (<i>10.02 DI delayed status</i> , bit 5).	7
	DIO1	Digital input/output DIO1 (<i>11.02 DIO delayed status</i> , bit 0).	10
	DIO2	Digital input/output DIO2 (<i>11.02 DIO delayed status</i> , bit 1).	11
	<i>Other [bit]</i>	Source selection (see <i>Terms and abbreviations</i> on page 90).	-
26.53	<i>Oscillation compensation input</i>	Selects the input signal for the oscillation damping function. Note: Before changing this parameter run-time, disable the oscillation damping output using parameter 26.52. Monitor the behavior of 26.58 before re-enabling the output.	<i>Speed error</i>
	Speed error	<i>24.01 Used speed reference - 24.02 Used speed feedback.</i> Note: This setting is not supported in scalar motor control mode.	0
	DC voltage	<i>01.11 DC voltage.</i> (The value is internally filtered.)	1



No.	Name/Value	Description	Def/FbEq16
26.55	<i>Oscillation damping frequency</i>	<p>Defines the center frequency of the oscillation damping filter.</p> <p>Set the value according to the number of oscillation peaks in the monitored signal (selected by 26.53) per second.</p> <p>Note: Before changing this parameter run-time, disable the oscillation damping output using parameter 26.52. Monitor the behavior of 26.58 before re-enabling the output.</p>	31.0 Hz
	0.1 ... 60.0 Hz	Center frequency for oscillation damping.	10 = 1 Hz
26.56	<i>Oscillation damping phase</i>	<p>Defines a phase shift for the output of the filter.</p> <p>Note: Before changing this parameter run-time, disable the oscillation damping output using parameter 26.52. Monitor the behavior of 26.58 before re-enabling the output.</p>	180 deg
	0...360 deg	Phase shift for oscillation damping function output.	10 = 1 deg
26.57	<i>Oscillation damping gain</i>	<p>Defines a gain for the output of the oscillation damping function, ie. how much the output of the filter is amplified before it is added to the torque reference.</p> <p>Oscillation gain is scaled according to the speed controller gain so that changing the gain will not disturb oscillation damping.</p> <p>Note: Before changing this parameter run-time, disable the oscillation damping output using parameter 26.52. Monitor the behavior of 26.58 before re-enabling the output.</p>	1.0%
	0.0 ... 100.0%	Gain setting for oscillation damping output.	10 = 1%
26.58	<i>Oscillation damping output</i>	<p>Displays the output of the oscillation damping function. This value is added to the torque reference (as allowed by parameter 26.52 <i>Oscillation damping out enable</i>).</p> <p>This parameter is read-only.</p>	-
	-1600.000 ... 1600.000%	Output of the oscillation damping function.	10 = 1%
26.70	<i>Torque reference act 1</i>	<p>Displays the value of torque reference source 1 (selected by parameter 26.11 <i>Torque ref1 source</i>).</p> <p>See the control chain diagram on page 573.</p> <p>This parameter is read-only.</p>	-
	-1600.0 ... 1600.0%	Value of torque reference source 1.	See par. 46.03

No.	Name/Value	Description	Def/FbEq16
26.71	<i>Torque reference act 2</i>	Displays the value of torque reference source 2 (selected by parameter 26.12 Torque ref2 source). See the control chain diagram on page 573 . This parameter is read-only.	-
	-1600.0 ... 1600.0%	Value of torque reference source 2.	See par. 46.03
26.72	<i>Torque reference act 3</i>	Displays the torque reference after the function applied by parameter 26.13 Torque ref1 function (if any), and after selection (26.14 Torque ref1/2 selection). See the control chain diagram on page 573 . This parameter is read-only.	-
	-1600.0 ... 1600.0%	Torque reference after selection.	See par. 46.03
26.73	<i>Torque reference act 4</i>	Displays the torque reference after application of reference additive 1. See the control chain diagram on page 573 . This parameter is read-only.	-
	-1600.0 ... 1600.0%	Torque reference after application of reference additive 1.	See par. 46.03
26.74	<i>Torque ref ramp out</i>	Displays the torque reference after limiting and ramping. See the control chain diagram on page 573 . This parameter is read-only.	-
	-1600.0 ... 1600.0%	Torque reference after limiting and ramping.	See par. 46.03
26.75	<i>Torque reference act 5</i>	Displays the torque reference after control mode selection. See the control chain diagram on page 575 . This parameter is read-only.	-
	-1600.0 ... 1600.0%	Torque reference after control mode selection.	See par. 46.03
26.76	<i>Torque reference act 6</i>	Displays the torque reference after application of reference additive 2. See the control chain diagram on page 575 . This parameter is read-only.	-
	-1600.0 ... 1600.0%	Torque reference after application of reference additive 2.	See par. 46.03
26.77	<i>Torque ref add A actual</i>	Displays the value of the source of torque reference additive 2. See the control chain diagram on page 575 . This parameter is read-only.	-
	-1600.0 ... 1600.0%	Torque reference additive 2.	See par. 46.03

No.	Name/Value	Description	Def/FbEq16
26.78	<i>Torque ref add B actual</i>	Displays the value of torque reference additive 2 before it is added to torque reference. See the control chain diagram on page 575. This parameter is read-only.	-
	-1600.0 ... 1600.0%	Torque reference additive 2.	See par. 46.03
26.81	<i>Rush control gain</i>	Rush controller gain term. See section <i>Rush control</i> (page 51).	10.0
	0.0 ...10000.0	Rush controller gain (0.0 = disabled).	1 = 1
26.82	<i>Rush control integration time</i>	Rush controller integration time term.	2.0 s
	0.0 ... 10.0 s	Rush controller integration time (0.0 = disabled).	1 = 1 s
28 Frequency reference chain		Settings for the frequency reference chain. See the control chain diagrams on pages 578 and 579.	
28.01	<i>Frequency ref ramp input</i>	Displays the used frequency reference before ramping. See the control chain diagram on page 579. This parameter is read-only.	-
	-500.00 ... 500.00 Hz	Frequency reference before ramping.	See par. 46.02
28.02	<i>Frequency ref ramp output</i>	Displays the final frequency reference (after selection, limitation and ramping). See the control chain diagram on page 579. This parameter is read-only.	-
	-500.00 ... 500.00 Hz	Final frequency reference.	See par. 46.02

No.	Name/Value	Description	Def/FbEq16
28.11	Frequency ref1 source	<p>Selects frequency reference source 1.</p> <p>Two signal sources can be defined by this parameter and 28.12 Frequency ref2 source. A digital source selected by 28.14 Frequency ref1/2 selection can be used to switch between the two sources, or a mathematical function (28.13 Frequency ref1 function) applied to the two signals to create the reference.</p>	Zero
Zero	None.	0	
AI1 scaled	12.12 AI1 scaled value (see page 137).	1	
AI2 scaled	12.22 AI2 scaled value (see page 140).	2	
FB A ref1	03.05 FB A reference 1 (see page 98).	4	
FB A ref2	03.06 FB A reference 2 (see page 98).	5	
EFB ref1	03.09 EFB reference 1 (see page 98).	8	
EFB ref2	03.10 EFB reference 2 (see page 99).	9	
M/F reference 1	03.13 M/F or D2D ref1 (see page 99).	12	
M/F reference 2	03.14 M/F or D2D ref2 (see page 99).	13	
Motor potentiometer	22.80 Motor potentiometer ref act (output of the motor potentiometer).	15	
PID	Reserved	16	
Control panel (ref saved)	Control panel reference, with initial value from last-used panel reference. See section Using the control panel as an external control source (page 27).	18	
Control panel (ref copied)	Control panel reference, with initial value from previous source or actual value. See section Using the control panel as an external control source (page 27).	19	
Other	Source selection (see Terms and abbreviations on page 90).	-	

No.	Name/Value	Description	Def/FbEq16
28.12	<i>Frequency ref2 source</i>	Selects frequency reference source 2. For the selections, and a diagram of reference source selection, see parameter 28.11 Frequency ref1 source .	Zero
28.13	<i>Frequency ref1 function</i>	Selects a mathematical function between the reference sources selected by parameters 28.11 Frequency ref1 source and 28.12 Frequency ref2 source . See diagram at 28.11 Frequency ref1 source .	Ref1
	Ref1	Signal selected by 28.11 Frequency ref1 source is used as frequency reference 1 as such (no function applied).	0
	Add (ref1 + ref2)	The sum of the reference sources is used as frequency reference 1.	1
	Sub (ref1 - ref2)	The subtraction ([28.11 Frequency ref1 source] - [28.12 Frequency ref2 source]) of the reference sources is used as frequency reference 1.	2
	Mul (ref1 × ref2)	The multiplication of the reference sources is used as frequency reference 1.	3
	Min (ref1, ref2)	The smaller of the reference sources is used as frequency reference 1.	4
	Max (ref1, ref2)	The greater of the reference sources is used as frequency reference 1.	5
28.14	<i>Frequency ref1/2 selection</i>	Configures the selection between frequency references 1 and 2. See diagram at 28.11 Frequency ref1 source . 0 = Frequency reference 1 1 = Frequency reference 2	<i>Follow Ext1/Ext2 selection</i>
	Frequency reference 1	0.	0
	Frequency reference 2	1.	1
	Follow Ext1/Ext2 selection	Frequency reference 1 is used when external control location EXT1 is active. Frequency reference 2 is used when external control location EXT2 is active. See also parameter 19.11 Ext1/Ext2 selection .	2
	DI1	Digital input DI1 (10.02 DI delayed status , bit 0).	3
	DI2	Digital input DI2 (10.02 DI delayed status , bit 1).	4
	DI3	Digital input DI3 (10.02 DI delayed status , bit 2).	5
	DI4	Digital input DI4 (10.02 DI delayed status , bit 3).	6
	DI5	Digital input DI5 (10.02 DI delayed status , bit 4).	7
	DI6	Digital input DI6 (10.02 DI delayed status , bit 5).	8

No.	Name/Value	Description	Def/FbEq16											
	<i>Other [bit]</i>	Source selection (see <i>Terms and abbreviations</i> on page 90).	-											
28.21	<i>Constant frequency function</i>	Determines how constant frequencies are selected, and whether the rotation direction signal is considered or not when applying a constant frequency.	0000b											
<table border="1"> <thead> <tr> <th>Bit</th> <th>Name</th> <th>Information</th> </tr> </thead> <tbody> <tr> <td rowspan="2">0</td> <td rowspan="2">Constant freq mode</td> <td>1 = Packed: 7 constant frequencies are selectable using the three sources defined by parameters 28.22, 28.23 and 28.24.</td> </tr> <tr> <td>0 = Separate: Constant frequencies 1, 2 and 3 are separately activated by the sources defined by parameters 28.22, 28.23 and 28.24 respectively. In case of conflict, the constant frequency with the smaller number takes priority.</td> </tr> <tr> <td rowspan="2">1</td> <td rowspan="2">Direction enable</td> <td>1 = Start dir: To determine running direction for a constant frequency, the sign of the constant frequency setting (parameters 28.26...28.32) is multiplied by the direction signal (forward: +1, reverse: -1). This effectively allows the drive to have 14 (7 forward, 7 reverse) constant frequencies if all values in 28.26...28.32 are positive.  WARNING: If the direction signal is reverse and the active constant frequency is negative, the drive will run in the forward direction.</td> </tr> <tr> <td>0 = According to Par: The running direction for the constant frequency is determined by the sign of the constant speed setting (parameters 28.26...28.32).</td> </tr> </tbody> </table>				Bit	Name	Information	0	Constant freq mode	1 = Packed: 7 constant frequencies are selectable using the three sources defined by parameters 28.22, 28.23 and 28.24.	0 = Separate: Constant frequencies 1, 2 and 3 are separately activated by the sources defined by parameters 28.22, 28.23 and 28.24 respectively. In case of conflict, the constant frequency with the smaller number takes priority.	1	Direction enable	1 = Start dir: To determine running direction for a constant frequency, the sign of the constant frequency setting (parameters 28.26...28.32) is multiplied by the direction signal (forward: +1, reverse: -1). This effectively allows the drive to have 14 (7 forward, 7 reverse) constant frequencies if all values in 28.26...28.32 are positive.  WARNING: If the direction signal is reverse and the active constant frequency is negative, the drive will run in the forward direction.	0 = According to Par: The running direction for the constant frequency is determined by the sign of the constant speed setting (parameters 28.26...28.32).
Bit	Name	Information												
0	Constant freq mode	1 = Packed: 7 constant frequencies are selectable using the three sources defined by parameters 28.22, 28.23 and 28.24.												
		0 = Separate: Constant frequencies 1, 2 and 3 are separately activated by the sources defined by parameters 28.22, 28.23 and 28.24 respectively. In case of conflict, the constant frequency with the smaller number takes priority.												
1	Direction enable	1 = Start dir: To determine running direction for a constant frequency, the sign of the constant frequency setting (parameters 28.26...28.32) is multiplied by the direction signal (forward: +1, reverse: -1). This effectively allows the drive to have 14 (7 forward, 7 reverse) constant frequencies if all values in 28.26...28.32 are positive.  WARNING: If the direction signal is reverse and the active constant frequency is negative, the drive will run in the forward direction.												
		0 = According to Par: The running direction for the constant frequency is determined by the sign of the constant speed setting (parameters 28.26...28.32).												
0000b...0011b		Constant frequency configuration word.	1 = 1											

No.	Name/Value	Description	Def/FbEq16																																				
28.22	<i>Constant frequency sel1</i>	<p>When bit 0 of parameter <i>28.21 Constant frequency function</i> is 0 (Separate), selects a source that activates constant frequency 1.</p> <p>When bit 0 of parameter <i>28.21 Constant frequency function</i> is 1 (Packed), this parameter and parameters <i>28.23 Constant frequency sel2</i> and <i>28.24 Constant frequency sel3</i> select three sources whose states activate constant frequencies as follows:</p>	<i>Not selected</i>																																				
<table border="1"> <thead> <tr> <th>Source defined by par. 28.22</th> <th>Source defined by par. 28.23</th> <th>Source defined by par. 28.24</th> <th>Constant frequency active</th> </tr> </thead> <tbody> <tr> <td>0</td> <td>0</td> <td>0</td> <td>None</td> </tr> <tr> <td>1</td> <td>0</td> <td>0</td> <td>Constant frequency 1</td> </tr> <tr> <td>0</td> <td>1</td> <td>0</td> <td>Constant frequency 2</td> </tr> <tr> <td>1</td> <td>1</td> <td>0</td> <td>Constant frequency 3</td> </tr> <tr> <td>0</td> <td>0</td> <td>1</td> <td>Constant frequency 4</td> </tr> <tr> <td>1</td> <td>0</td> <td>1</td> <td>Constant frequency 5</td> </tr> <tr> <td>0</td> <td>1</td> <td>1</td> <td>Constant frequency 6</td> </tr> <tr> <td>1</td> <td>1</td> <td>1</td> <td>Constant frequency 7</td> </tr> </tbody> </table>				Source defined by par. 28.22	Source defined by par. 28.23	Source defined by par. 28.24	Constant frequency active	0	0	0	None	1	0	0	Constant frequency 1	0	1	0	Constant frequency 2	1	1	0	Constant frequency 3	0	0	1	Constant frequency 4	1	0	1	Constant frequency 5	0	1	1	Constant frequency 6	1	1	1	Constant frequency 7
Source defined by par. 28.22	Source defined by par. 28.23	Source defined by par. 28.24	Constant frequency active																																				
0	0	0	None																																				
1	0	0	Constant frequency 1																																				
0	1	0	Constant frequency 2																																				
1	1	0	Constant frequency 3																																				
0	0	1	Constant frequency 4																																				
1	0	1	Constant frequency 5																																				
0	1	1	Constant frequency 6																																				
1	1	1	Constant frequency 7																																				
Not selected	0.	0																																					
Selected	1.	1																																					
DI1	Digital input DI1 (<i>10.02 DI delayed status</i> , bit 0).	2																																					
DI2	Digital input DI2 (<i>10.02 DI delayed status</i> , bit 1).	3																																					
DI3	Digital input DI3 (<i>10.02 DI delayed status</i> , bit 2).	4																																					
DI4	Digital input DI4 (<i>10.02 DI delayed status</i> , bit 3).	5																																					
DI5	Digital input DI5 (<i>10.02 DI delayed status</i> , bit 4).	6																																					
DI6	Digital input DI6 (<i>10.02 DI delayed status</i> , bit 5).	7																																					
DIO1	Digital input/output DIO1 (<i>11.02 DIO delayed status</i> , bit 0).	10																																					
DIO2	Digital input/output DIO2 (<i>11.02 DIO delayed status</i> , bit 1).	11																																					
<i>Other [bit]</i>	Source selection (see <i>Terms and abbreviations</i> on page 90).	-																																					

No.	Name/Value	Description	Def/FbEq16
28.23	<i>Constant frequency sel2</i>	<p>When bit 0 of parameter 28.21 Constant frequency function is 0 (Separate), selects a source that activates constant frequency 2.</p> <p>When bit 0 of parameter 28.21 Constant frequency function is 1 (Packed), this parameter and parameters 28.22 Constant frequency sel1 and 28.24 Constant frequency sel3 select three sources that are used to activate constant frequencies. See table at parameter 28.22 Constant frequency sel1.</p> <p>For the selections, see parameter 28.22 Constant frequency sel1.</p>	<i>Not selected</i>
28.24	<i>Constant frequency sel3</i>	<p>When bit 0 of parameter 28.21 Constant frequency function is 0 (Separate), selects a source that activates constant frequency 3.</p> <p>When bit 0 of parameter 28.21 Constant frequency function is 1 (Packed), this parameter and parameters 28.22 Constant frequency sel1 and 28.23 Constant frequency sel2 select three sources that are used to activate constant frequencies. See table at parameter 28.22 Constant frequency sel1.</p> <p>For the selections, see parameter 28.22 Constant frequency sel1.</p>	<i>Not selected</i>
28.26	<i>Constant frequency 1</i>	Defines constant frequency 1 (the frequency the motor will turn when constant frequency 1 is selected).	0.00 Hz
	-500.00 ... 500.00 Hz	Constant frequency 1.	See par. 46.02
28.27	<i>Constant frequency 2</i>	Defines constant frequency 2.	0.00 Hz
	-500.00 ... 500.00 Hz	Constant frequency 2.	See par. 46.02
28.28	<i>Constant frequency 3</i>	Defines constant frequency 3.	0.00 Hz
	-500.00 ... 500.00 Hz	Constant frequency 3.	See par. 46.02
28.29	<i>Constant frequency 4</i>	Defines constant frequency 4.	0.00 Hz
	-500.00 ... 500.00 Hz	Constant frequency 4.	See par. 46.02
28.30	<i>Constant frequency 5</i>	Defines constant frequency 5.	0.00 Hz
	-500.00 ... 500.00 Hz	Constant frequency 5.	See par. 46.02

No.	Name/Value	Description	Def/FbEq16											
28.31	<i>Constant frequency 6</i>	Defines constant frequency 6.	0.00 Hz											
	-500.00 ... 500.00 Hz	Constant frequency 6.	See par. 46.02											
28.32	<i>Constant frequency 7</i>	Defines constant frequency 7.	0.00 Hz											
	-500.00 ... 500.00 Hz	Constant frequency 7.	See par. 46.02											
28.41	<i>Frequency ref safe</i>	Defines a safe frequency reference value that is used with supervision functions such as <ul style="list-style-type: none"> • 12.03 AI supervision function • 49.05 Communication loss action • 50.02 FBA A comm loss func • 50.32 FBA B comm loss func • 58.14 Communication loss action. 	0.00 Hz											
	-500.00 ... 500.00 Hz	Safe frequency reference.	See par. 46.02											
28.51	<i>Critical frequency function</i>	Enables/disables the critical frequencies function. Also determines whether the specified ranges are effective in both rotating directions or not. See also section Critical speeds/frequencies (page 46).	0000b											
<table border="1"> <thead> <tr> <th>Bit</th> <th>Name</th> <th>Information</th> </tr> </thead> <tbody> <tr> <td rowspan="2">0</td> <td rowspan="2">Enable</td> <td>1 = Enable: Critical frequencies enabled.</td> </tr> <tr> <td>0 = Disable: Critical frequencies disabled.</td> </tr> <tr> <td rowspan="2">1</td> <td rowspan="2">Sign mode</td> <td>1 = According to par: The signs of parameters 28.52...28.57 are taken into account.</td> </tr> <tr> <td>0 = Absolute: Parameters 28.52...28.57 are handled as absolute values. Each range is effective in both directions of rotation.</td> </tr> </tbody> </table>				Bit	Name	Information	0	Enable	1 = Enable: Critical frequencies enabled.	0 = Disable: Critical frequencies disabled.	1	Sign mode	1 = According to par: The signs of parameters 28.52...28.57 are taken into account.	0 = Absolute: Parameters 28.52...28.57 are handled as absolute values. Each range is effective in both directions of rotation.
Bit	Name	Information												
0	Enable	1 = Enable: Critical frequencies enabled.												
		0 = Disable: Critical frequencies disabled.												
1	Sign mode	1 = According to par: The signs of parameters 28.52...28.57 are taken into account.												
		0 = Absolute: Parameters 28.52...28.57 are handled as absolute values. Each range is effective in both directions of rotation.												
	0000b...0011b	Critical frequencies configuration word.	1 = 1											
28.52	<i>Critical frequency 1 low</i>	Defines the low limit for critical frequency 1. Note: This value must be less than or equal to the value of 28.53 Critical frequency 1 high .	0.00 Hz											
	-500.00 ... 500.00 Hz	Low limit for critical frequency 1.	See par. 46.02											
28.53	<i>Critical frequency 1 high</i>	Defines the high limit for critical frequency 1. Note: This value must be greater than or equal to the value of 28.52 Critical frequency 1 low .	0.00 Hz											
	-500.00 ... 500.00 Hz	High limit for critical frequency 1.	See par. 46.02											

No.	Name/Value	Description	Def/FbEq16
28.54	<i>Critical frequency 2 low</i>	Defines the low limit for critical frequency 2. Note: This value must be less than or equal to the value of <i>28.55 Critical frequency 2 high</i> .	0.00 Hz
	-500.00 ... 500.00 Hz	Low limit for critical frequency 2.	See par. <i>46.02</i>
28.55	<i>Critical frequency 2 high</i>	Defines the high limit for critical frequency 2. Note: This value must be greater than or equal to the value of <i>28.54 Critical frequency 2 low</i> .	0.00 Hz
	-500.00 ... 500.00 Hz	High limit for critical frequency 2.	See par. <i>46.02</i>
28.56	<i>Critical frequency 3 low</i>	Defines the low limit for critical frequency 3. Note: This value must be less than or equal to the value of <i>28.57 Critical frequency 3 high</i> .	0.00 Hz
	-500.00 ... 500.00 Hz	Low limit for critical frequency 3.	See par. <i>46.02</i>
28.57	<i>Critical frequency 3 high</i>	Defines the high limit for critical frequency 3. Note: This value must be greater than or equal to the value of <i>28.56 Critical frequency 3 low</i> .	0.00 Hz
	-500.00 ... 500.00 Hz	High limit for critical frequency 3.	See par. <i>46.02</i>
28.71	<i>Freq ramp set selection</i>	Selects a source that switches between the two sets of acceleration/deceleration times defined by parameters <i>28.72...28.75</i> . 0 = Acceleration time 1 and deceleration time 1 are in force 1 = Acceleration time 2 and deceleration time 2 are in force	<i>Acc/Dec time 1</i>
	Acc/Dec time 1	0.	0
	Acc/Dec time 2	1.	1
	DI1	Digital input DI1 (<i>10.02 DI delayed status</i> , bit 0).	2
	DI2	Digital input DI2 (<i>10.02 DI delayed status</i> , bit 1).	3
	DI3	Digital input DI3 (<i>10.02 DI delayed status</i> , bit 2).	4
	DI4	Digital input DI4 (<i>10.02 DI delayed status</i> , bit 3).	5
	DI5	Digital input DI5 (<i>10.02 DI delayed status</i> , bit 4).	6
	DI6	Digital input DI6 (<i>10.02 DI delayed status</i> , bit 5).	7
	DIO1	Digital input/output DIO1 (<i>11.02 DIO delayed status</i> , bit 0).	10
	DIO2	Digital input/output DIO2 (<i>11.02 DIO delayed status</i> , bit 1).	11
	<i>Other [bit]</i>	Source selection (see <i>Terms and abbreviations</i> on page 90).	-

No.	Name/Value	Description	Def/FbEq16
28.72	<i>Freq acceleration time 1</i>	<p>Defines acceleration time 1 as the time required for the frequency to change from zero to the frequency defined by parameter 46.02 Frequency scaling (not to parameter 30.14 Maximum frequency).</p> <p>If the reference increases faster than the set acceleration rate, the motor will follow the acceleration rate.</p> <p>If the reference increases slower than the set acceleration rate, the motor frequency will follow the reference.</p> <p>If the acceleration time is set too short, the drive will automatically prolong the acceleration in order not to exceed the drive torque limits.</p>	20.000 s
	0.000 ... 1800.000 s	Acceleration time 1.	10 = 1 s
28.73	<i>Freq deceleration time 1</i>	<p>Defines deceleration time 1 as the time required for the frequency to change from the frequency defined by parameter 46.02 Frequency scaling (not from parameter 30.14 Maximum frequency) to zero.</p> <p>If there is any doubt about the deceleration time being too short, ensure that DC overvoltage control (30.30 Overvoltage control) is on.</p> <p>Note: If a short deceleration time is needed for a high inertia application, the drive should be equipped with braking equipment such as a brake chopper and brake resistor.</p>	20.000 s
	0.000 ... 1800.000 s	Deceleration time 1.	10 = 1 s
28.74	<i>Freq acceleration time 2</i>	Defines acceleration time 2. See parameter 28.72 Freq acceleration time 1 .	60.000 s
	0.000 ... 1800.000 s	Acceleration time 2.	10 = 1 s
28.75	<i>Freq deceleration time 2</i>	Defines deceleration time 2. See parameter 28.73 Freq deceleration time 1 .	60.000 s
	0.000 ... 1800.000 s	Deceleration time 2.	10 = 1 s
28.76	<i>Freq ramp in zero source</i>	<p>Selects a source that forces the frequency reference to zero.</p> <p>0 = Force frequency reference to zero 1 = Normal operation</p>	<i>Inactive</i>
	Active	0.	0
	Inactive	1.	1
	DI1	Digital input DI1 (10.02 DI delayed status , bit 0).	2











No.	Name/Value	Description	Def/FbEq16
	DI2	Digital input DI2 (10.02 DI delayed status , bit 1).	3
	DI3	Digital input DI3 (10.02 DI delayed status , bit 2).	4
	DI4	Digital input DI4 (10.02 DI delayed status , bit 3).	5
	DI5	Digital input DI5 (10.02 DI delayed status , bit 4).	6
	DI6	Digital input DI6 (10.02 DI delayed status , bit 5).	7
	DIO1	Digital input/output DIO1 (11.02 DIO delayed status , bit 0).	10
	DIO2	Digital input/output DIO2 (11.02 DIO delayed status , bit 1).	11
	<i>Other [bit]</i>	Source selection (see Terms and abbreviations on page 90).	-
28.77	<i>Freq ramp hold</i>	Selects a source that forces the output of the frequency ramp generator to actual frequency value. 0 = Force ramp output to actual frequency 1 = Normal operation	<i>Inactive</i>
	Active	0.	0
	Inactive	1.	1
	DI1	Digital input DI1 (10.02 DI delayed status , bit 0).	2
	DI2	Digital input DI2 (10.02 DI delayed status , bit 1).	3
	DI3	Digital input DI3 (10.02 DI delayed status , bit 2).	4
	DI4	Digital input DI4 (10.02 DI delayed status , bit 3).	5
	DI5	Digital input DI5 (10.02 DI delayed status , bit 4).	6
	DI6	Digital input DI6 (10.02 DI delayed status , bit 5).	7
	DIO1	Digital input/output DIO1 (11.02 DIO delayed status , bit 0).	10
	DIO2	Digital input/output DIO2 (11.02 DIO delayed status , bit 1).	11
	<i>Other [bit]</i>	Source selection (see Terms and abbreviations on page 90).	-
28.78	<i>Freq ramp output balancing</i>	Defines a reference for frequency ramp balancing. The output of the ramp generator is forced to this value when balancing is enabled by parameter 28.79 Freq ramp out balancing enable .	0.00 Hz
	-500.00 ... 500.00 Hz	Frequency ramp balancing reference.	See par. 46.02
28.79	<i>Freq ramp out balancing enable</i>	Selects the source for enabling/disabling speed ramp balancing. See parameter 28.78 Freq ramp output balancing .	<i>Not selected</i>
	Not selected	0.	0
	Selected	1.	1

No.	Name/Value	Description	Def/FbEq16
	DI1	Digital input DI1 (10.02 DI delayed status , bit 0).	2
	DI2	Digital input DI2 (10.02 DI delayed status , bit 1).	3
	DI3	Digital input DI3 (10.02 DI delayed status , bit 2).	4
	DI4	Digital input DI4 (10.02 DI delayed status , bit 3).	5
	DI5	Digital input DI5 (10.02 DI delayed status , bit 4).	6
	DI6	Digital input DI6 (10.02 DI delayed status , bit 5).	7
	DIO1	Digital input/output DIO1 (11.02 DIO delayed status , bit 0).	10
	DIO2	Digital input/output DIO2 (11.02 DIO delayed status , bit 1).	11
	<i>Other [bit]</i>	Source selection (see Terms and abbreviations on page 90).	-
28.90	Frequency ref act 1	Displays the value of frequency reference source 1 (selected by parameter 28.11 Frequency ref1 source). See the control chain diagram on page 578. This parameter is read-only.	-
	-500.00 ... 500.00 Hz	Value of frequency reference source 1.	See par. 46.02
28.91	Frequency ref act 2	Displays the value of frequency reference source 2 (selected by parameter 28.12 Frequency ref2 source). See the control chain diagram on page 578. This parameter is read-only.	-
	-500.00 ... 500.00 Hz	Value of frequency reference source 2.	See par. 46.02
28.92	Frequency ref act 3	Displays the frequency reference after the function applied by parameter 28.13 Frequency ref1 function (if any), and after selection (28.14 Frequency ref1/2 selection). See the control chain diagram on page 578. This parameter is read-only.	-
	-500.00 ... 500.00 Hz	Frequency reference after selection.	See par. 46.02
28.96	Frequency ref act 7	Displays the frequency reference after application of constant frequencies, control panel reference, etc. See the control chain diagram on page 578. This parameter is read-only.	-
	-500.00 ... 500.00 Hz	Frequency reference 7.	See par. 46.02

No.	Name/Value	Description	Def/FbEq16
28.97	Frequency ref unlimited	Displays the frequency reference after application of critical frequencies, but before ramping and limiting. See the control chain diagram on page 579 . This parameter is read-only.	-
	-500.00 ... 500.00 Hz	Frequency reference before ramping and limiting.	See par. 46.02

No.	Name/Value	Description	Def/FbEq16																																													
30 Limits		Drive operation limits.																																														
30.01	<i>Limit word 1</i>	Displays limit word 1. This parameter is read-only.	-																																													
<table border="1"> <thead> <tr> <th>Bit</th> <th>Name</th> <th>Description</th> </tr> </thead> <tbody> <tr> <td>0</td> <td>Torq lim</td> <td>1 = Drive torque is being limited by the motor control (undervoltage control, current control, load angle control or pull-out control), or by the torque limits defined by parameters.</td> </tr> <tr> <td>1</td> <td>Spd ctl tlim min</td> <td>1 = Speed controller output is being limited by 25.11 Speed control min torque</td> </tr> <tr> <td>2</td> <td>Spd ctl tlim max</td> <td>1 = Speed controller output is being limited by 25.12 Speed control max torque</td> </tr> <tr> <td>3</td> <td>Torq ref max</td> <td>1 = Torque reference ramp input is being limited by 26.09 Maximum torque ref, source of 30.25 Maximum torque sel, 30.26 Power motoring limit or 30.27 Power generating limit. See diagram on page 576.</td> </tr> <tr> <td>4</td> <td>Torq ref min</td> <td>1 = Torque reference ramp input is being limited by 26.08 Minimum torque ref, source of 30.18 Minimum torque sel, 30.26 Power motoring limit or 30.27 Power generating limit. See diagram on page 576.</td> </tr> <tr> <td>5</td> <td>Tlim max speed</td> <td>1 = Torque reference is being limited by the rush control because of maximum speed limit (30.12 Maximum speed)</td> </tr> <tr> <td>6</td> <td>Tlim min speed</td> <td>1 = Torque reference is being limited by the rush control because of minimum speed limit (30.11 Minimum speed)</td> </tr> <tr> <td>7</td> <td>Max speed ref lim</td> <td>1 = Speed reference is being limited by 30.12 Maximum speed</td> </tr> <tr> <td>8</td> <td>Min speed ref lim</td> <td>1 = Speed reference is being limited by 30.11 Minimum speed</td> </tr> <tr> <td>9</td> <td>Max freq ref lim</td> <td>1 = Frequency reference is being limited by 30.14 Maximum frequency</td> </tr> <tr> <td>10</td> <td>Min freq ref lim</td> <td>1 = Frequency reference is being limited by 30.13 Minimum frequency</td> </tr> <tr> <td>11</td> <td colspan="2">Reserved</td> </tr> <tr> <td>12</td> <td>Sw freq ref lim</td> <td>1 = Requested output frequency cannot be reached because of switching frequency limitation (because of eg. output filtering or ATEX-related protections)</td> </tr> <tr> <td>13...15</td> <td colspan="2">Reserved</td> </tr> </tbody> </table>				Bit	Name	Description	0	Torq lim	1 = Drive torque is being limited by the motor control (undervoltage control, current control, load angle control or pull-out control), or by the torque limits defined by parameters.	1	Spd ctl tlim min	1 = Speed controller output is being limited by 25.11 Speed control min torque	2	Spd ctl tlim max	1 = Speed controller output is being limited by 25.12 Speed control max torque	3	Torq ref max	1 = Torque reference ramp input is being limited by 26.09 Maximum torque ref , source of 30.25 Maximum torque sel , 30.26 Power motoring limit or 30.27 Power generating limit . See diagram on page 576.	4	Torq ref min	1 = Torque reference ramp input is being limited by 26.08 Minimum torque ref , source of 30.18 Minimum torque sel , 30.26 Power motoring limit or 30.27 Power generating limit . See diagram on page 576.	5	Tlim max speed	1 = Torque reference is being limited by the rush control because of maximum speed limit (30.12 Maximum speed)	6	Tlim min speed	1 = Torque reference is being limited by the rush control because of minimum speed limit (30.11 Minimum speed)	7	Max speed ref lim	1 = Speed reference is being limited by 30.12 Maximum speed	8	Min speed ref lim	1 = Speed reference is being limited by 30.11 Minimum speed	9	Max freq ref lim	1 = Frequency reference is being limited by 30.14 Maximum frequency	10	Min freq ref lim	1 = Frequency reference is being limited by 30.13 Minimum frequency	11	Reserved		12	Sw freq ref lim	1 = Requested output frequency cannot be reached because of switching frequency limitation (because of eg. output filtering or ATEX-related protections)	13...15	Reserved	
Bit	Name	Description																																														
0	Torq lim	1 = Drive torque is being limited by the motor control (undervoltage control, current control, load angle control or pull-out control), or by the torque limits defined by parameters.																																														
1	Spd ctl tlim min	1 = Speed controller output is being limited by 25.11 Speed control min torque																																														
2	Spd ctl tlim max	1 = Speed controller output is being limited by 25.12 Speed control max torque																																														
3	Torq ref max	1 = Torque reference ramp input is being limited by 26.09 Maximum torque ref , source of 30.25 Maximum torque sel , 30.26 Power motoring limit or 30.27 Power generating limit . See diagram on page 576.																																														
4	Torq ref min	1 = Torque reference ramp input is being limited by 26.08 Minimum torque ref , source of 30.18 Minimum torque sel , 30.26 Power motoring limit or 30.27 Power generating limit . See diagram on page 576.																																														
5	Tlim max speed	1 = Torque reference is being limited by the rush control because of maximum speed limit (30.12 Maximum speed)																																														
6	Tlim min speed	1 = Torque reference is being limited by the rush control because of minimum speed limit (30.11 Minimum speed)																																														
7	Max speed ref lim	1 = Speed reference is being limited by 30.12 Maximum speed																																														
8	Min speed ref lim	1 = Speed reference is being limited by 30.11 Minimum speed																																														
9	Max freq ref lim	1 = Frequency reference is being limited by 30.14 Maximum frequency																																														
10	Min freq ref lim	1 = Frequency reference is being limited by 30.13 Minimum frequency																																														
11	Reserved																																															
12	Sw freq ref lim	1 = Requested output frequency cannot be reached because of switching frequency limitation (because of eg. output filtering or ATEX-related protections)																																														
13...15	Reserved																																															
0000h...FFFFh		Limit word 1.	1 = 1																																													

No.	Name/Value	Description	Def/FbEq16																																																
30.02	<i>Torque limit status</i>	Displays the torque controller limitation status word. This parameter is read-only.	-																																																
<table border="1"> <thead> <tr> <th>Bit</th> <th>Name</th> <th>Description</th> </tr> </thead> <tbody> <tr> <td>0</td> <td>Undervoltage</td> <td>*1 = Intermediate DC circuit undervoltage</td> </tr> <tr> <td>1</td> <td>Overvoltage</td> <td>*1 = Intermediate DC circuit overvoltage</td> </tr> <tr> <td>2</td> <td>Minimum torque</td> <td>*1 = Torque is being limited by 30.26 Power motoring limit, 30.27 Power generating limit or the source of 30.18 Minimum torque sel. See diagram on page 576.</td> </tr> <tr> <td>3</td> <td>Maximum torque</td> <td>*1 = Torque is being limited by 30.26 Power motoring limit, 30.27 Power generating limit or the source of 30.25 Maximum torque sel. See diagram on page 576.</td> </tr> <tr> <td>4</td> <td>Internal current</td> <td>1 = An inverter current limit (identified by bits 8...11) is active</td> </tr> <tr> <td>5</td> <td>Load angle</td> <td>(With permanent magnet motors and synchronous reluctance motors only) 1 = Load angle limit is active, ie. the motor cannot produce any more torque</td> </tr> <tr> <td>6</td> <td>Motor pullout</td> <td>(With asynchronous motors only) 1 = Motor pull-out limit is active, ie. the motor cannot produce any more torque</td> </tr> <tr> <td>7</td> <td>Reserved</td> <td></td> </tr> <tr> <td>8</td> <td>Thermal</td> <td>1 = Input current is being limited by the main circuit thermal limit</td> </tr> <tr> <td>9</td> <td>Max current</td> <td>*1 = Maximum output current (I_{MAX}) is being limited</td> </tr> <tr> <td>10</td> <td>User current</td> <td>*1 = Output current is being limited by 30.17 Maximum current</td> </tr> <tr> <td>11</td> <td>Thermal IGBT</td> <td>*1 = Output current is being limited by a calculated thermal current value</td> </tr> <tr> <td>12</td> <td>IGBT overtemperature</td> <td>*1 = Output current is being limited because of estimated IGBT temperature</td> </tr> <tr> <td>13</td> <td>IGBT overload</td> <td>*1 = Output current is being limited because of IGBT junction to case temperature</td> </tr> <tr> <td>14...15</td> <td>Reserved</td> <td></td> </tr> </tbody> </table> <p>*Only one out of bits 0...3, and one out of bits 9...13 can be on simultaneously. The bit typically indicates the limit that is exceeded first.</p>				Bit	Name	Description	0	Undervoltage	*1 = Intermediate DC circuit undervoltage	1	Overvoltage	*1 = Intermediate DC circuit overvoltage	2	Minimum torque	*1 = Torque is being limited by 30.26 Power motoring limit , 30.27 Power generating limit or the source of 30.18 Minimum torque sel. See diagram on page 576.	3	Maximum torque	*1 = Torque is being limited by 30.26 Power motoring limit , 30.27 Power generating limit or the source of 30.25 Maximum torque sel. See diagram on page 576.	4	Internal current	1 = An inverter current limit (identified by bits 8...11) is active	5	Load angle	(With permanent magnet motors and synchronous reluctance motors only) 1 = Load angle limit is active, ie. the motor cannot produce any more torque	6	Motor pullout	(With asynchronous motors only) 1 = Motor pull-out limit is active, ie. the motor cannot produce any more torque	7	Reserved		8	Thermal	1 = Input current is being limited by the main circuit thermal limit	9	Max current	*1 = Maximum output current (I_{MAX}) is being limited	10	User current	*1 = Output current is being limited by 30.17 Maximum current	11	Thermal IGBT	*1 = Output current is being limited by a calculated thermal current value	12	IGBT overtemperature	*1 = Output current is being limited because of estimated IGBT temperature	13	IGBT overload	*1 = Output current is being limited because of IGBT junction to case temperature	14...15	Reserved	
Bit	Name	Description																																																	
0	Undervoltage	*1 = Intermediate DC circuit undervoltage																																																	
1	Overvoltage	*1 = Intermediate DC circuit overvoltage																																																	
2	Minimum torque	*1 = Torque is being limited by 30.26 Power motoring limit , 30.27 Power generating limit or the source of 30.18 Minimum torque sel. See diagram on page 576.																																																	
3	Maximum torque	*1 = Torque is being limited by 30.26 Power motoring limit , 30.27 Power generating limit or the source of 30.25 Maximum torque sel. See diagram on page 576.																																																	
4	Internal current	1 = An inverter current limit (identified by bits 8...11) is active																																																	
5	Load angle	(With permanent magnet motors and synchronous reluctance motors only) 1 = Load angle limit is active, ie. the motor cannot produce any more torque																																																	
6	Motor pullout	(With asynchronous motors only) 1 = Motor pull-out limit is active, ie. the motor cannot produce any more torque																																																	
7	Reserved																																																		
8	Thermal	1 = Input current is being limited by the main circuit thermal limit																																																	
9	Max current	*1 = Maximum output current (I_{MAX}) is being limited																																																	
10	User current	*1 = Output current is being limited by 30.17 Maximum current																																																	
11	Thermal IGBT	*1 = Output current is being limited by a calculated thermal current value																																																	
12	IGBT overtemperature	*1 = Output current is being limited because of estimated IGBT temperature																																																	
13	IGBT overload	*1 = Output current is being limited because of IGBT junction to case temperature																																																	
14...15	Reserved																																																		
0000h...FFFFh	Torque limitation status word.	1 = 1																																																	

No.	Name/Value	Description	Def/FbEq16
30.11	<i>Minimum speed</i>	Defines the minimum allowed speed.  WARNING! This value must not be higher than <i>30.12 Maximum speed</i> .  WARNING! In frequency control mode, this limit is not effective. Make sure the frequency limits (<i>30.13</i> and <i>30.14</i>) are set appropriately if frequency control is used.  WARNING! In a master/follower configuration, do not set maximum and minimum speed limits with the same sign on a follower drive. See section <i>Master/follower functionality</i> (page 39).	-1500.00 rpm; -1800.00 rpm (95.20 b0)
	-30000.00 ... 30000.00 rpm	Minimum allowed speed.	See par. 46.01
30.12	<i>Maximum speed</i>	Defines the maximum allowed speed.  WARNING! This value must not be lower than <i>30.11 Minimum speed</i> .  WARNING! In frequency control mode, this limit is not effective. Make sure the frequency limits (<i>30.13</i> and <i>30.14</i>) are set appropriately if frequency control is used.  WARNING! In a master/follower configuration, do not set maximum and minimum speed limits with the same sign on a follower drive. See section <i>Master/follower functionality</i> (page 39).	1500.00 rpm; 1800.00 rpm (95.20 b0)
	-30000.00 ... 30000.00 rpm	Maximum speed.	See par. 46.01
30.13	<i>Minimum frequency</i>	Defines the minimum allowed frequency.  WARNING! This value must not be higher than <i>30.14 Maximum frequency</i> .  WARNING! This limit is effective in frequency control mode only.	-50.00 Hz; -60.00 Hz (95.20 b0)
	-500.00 ... 500.00 Hz	Minimum frequency.	See par. 46.02
30.14	<i>Maximum frequency</i>	Defines the maximum allowed frequency.  WARNING! This value must not be lower than <i>30.13 Minimum frequency</i> .  WARNING! This limit is effective in frequency control mode only.	50.00 Hz; 60.00 Hz (95.20 b0)
	-500.00 ... 500.00 Hz	Maximum frequency.	See par. 46.02

No.	Name/Value	Description	Def/FbEq16
30.15	<i>Maximum start current enable</i>	<p>A temporary motor current limit specifically for starting can be defined by this parameter and 30.16 Maximum start current.</p> <p>When this parameter is set to <i>Enable</i>, the drive observes the start current limit defined by 30.16 Maximum start current. The limit is in force for 2 seconds after initial magnetization (of an asynchronous induction motor) or autophasing (of a permanent magnet motor), but not more often than once in every 7 seconds. Otherwise, the limit defined by 30.17 Maximum current is in force.</p> <p>Note: The availability of a start current higher than the general limit depends on drive hardware.</p>	<i>Disable</i>
	Disable	Start current limit disabled.	0
	Enable	Start current limit enabled.	1
30.16	<i>Maximum start current</i>	Defines a maximum start current when enabled by parameter 30.15 Maximum start current enable .	-
	0.00 ... 30000.00 A	Maximum start current.	1 = 1 A
30.17	<i>Maximum current</i>	Defines the maximum allowed motor current.	0.00 A
	0.00 ... 30000.00 A	Maximum motor current.	1 = 1 A

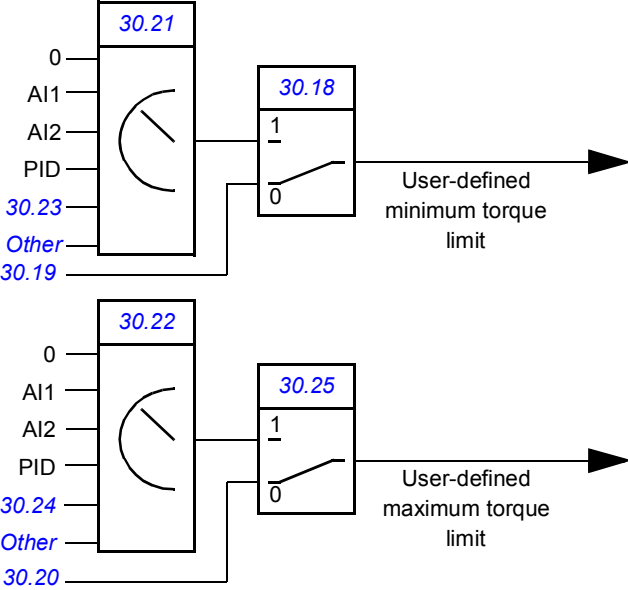
No.	Name/Value	Description	Def/FbEq16
30.18	Minimum torque sel	<p>Selects a source that switches between two different predefined minimum torque limits.</p> <p>0 = Minimum torque limit defined by 30.19 is active 1 = Minimum torque limit selected by 30.21 is active</p> <p>The user can define two sets of torque limits, and switch between the sets using a binary source such as a digital input. The minimum limit selection (30.18) is independent of the maximum limit selection (30.25).</p> <p>The first set of limits is defined by parameters 30.19 and 30.20. The second set has selector parameters for both the minimum (30.21) and maximum (30.22) limits that allows the use of a selectable analog source (such as an analog input).</p> 	Minimum torque 1
Minimum torque 1	0 (minimum torque limit defined by 30.19 is active).	0	
Minimum torque 2 source	1 (minimum torque limit selected by 30.21 is active).	1	
DI1	Digital input DI1 (10.02 DI delayed status, bit 0).	2	
DI2	Digital input DI2 (10.02 DI delayed status, bit 1).	3	
DI3	Digital input DI3 (10.02 DI delayed status, bit 2).	4	
DI4	Digital input DI4 (10.02 DI delayed status, bit 3).	5	
DI5	Digital input DI5 (10.02 DI delayed status, bit 4).	6	
DI6	Digital input DI6 (10.02 DI delayed status, bit 5).	7	

Note: In addition to the user-defined limits, torque may be limited for other reasons (such as power limitation). Refer to the block diagram on page 576.

No.	Name/Value	Description	Def/FbEq16
	DIO1	Digital input/output DIO1 (11.02 DIO delayed status , bit 0).	10
	DIO2	Digital input/output DIO2 (11.02 DIO delayed status , bit 1).	11
	<i>Other [bit]</i>	Source selection (see Terms and abbreviations on page 90).	-
30.19	Minimum torque 1	Defines a minimum torque limit for the drive (in percent of nominal motor torque). See diagram at parameter 30.18 Minimum torque sel . The limit is effective when <ul style="list-style-type: none"> the source selected by 30.18 Minimum torque sel is 0, or 30.18 is set to Minimum torque 1. 	-300.0%
	-1600.0 ... 0.0%	Minimum torque limit 1.	See par. 46.03
30.20	Maximum torque 1	Defines a maximum torque limit for the drive (in percent of nominal motor torque). See diagram at parameter 30.18 Minimum torque sel . The limit is effective when <ul style="list-style-type: none"> the source selected by 30.25 Maximum torque sel is 0, or 30.25 is set to Maximum torque 1. 	300.0%
	0.0 ... 1600.0%	Maximum torque 1.	See par. 46.03
30.21	Minimum torque 2 source	Defines the source of the minimum torque limit for the drive (in percent of nominal motor torque) when <ul style="list-style-type: none"> the source selected by parameter 30.18 Minimum torque sel is 1, or 30.18 is set to Minimum torque 2 source. See diagram at 30.18 Minimum torque sel . Note: Any positive values received from the selected source are inverted.	Minimum torque 2
	Zero	None.	0
	AI1 scaled	12.12 AI1 scaled value (see page 137).	1
	AI2 scaled	12.22 AI2 scaled value (see page 140).	2
	Minimum torque 2	30.23 Minimum torque 2 .	6
	<i>Other</i>	Source selection (see Terms and abbreviations on page 90).	-

No.	Name/Value	Description	Def/FbEq16
30.22	<i>Maximum torque 2 source</i>	<p>Defines the source of the maximum torque limit for the drive (in percent of nominal motor torque) when</p> <ul style="list-style-type: none"> the source selected by parameter <i>30.25 Maximum torque sel</i> is 1, or <i>30.25</i> is set to <i>Maximum torque 2 source</i>. <p>See diagram at <i>30.18 Minimum torque sel</i>.</p> <p>Note: Any negative values received from the selected source are inverted.</p>	<i>Maximum torque 2</i>
	Zero	None.	0
	A11 scaled	<i>12.12 A11 scaled value</i> (see page 137).	1
	A12 scaled	<i>12.22 A12 scaled value</i> (see page 140).	2
	Maximum torque 2	<i>30.24 Maximum torque 2</i> .	6
	<i>Other</i>	Source selection (see <i>Terms and abbreviations</i> on page 90).	-
30.23	<i>Minimum torque 2</i>	<p>Defines the minimum torque limit for the drive (in percent of nominal motor torque) when</p> <ul style="list-style-type: none"> the source selected by parameter <i>30.18 Minimum torque sel</i> is 1, and <i>30.21</i> is set to <i>Minimum torque 2</i>. <p>See diagram at <i>30.18 Minimum torque sel</i>.</p>	-300.0%
	-1600.0 ... 0.0%	Minimum torque limit 2.	See par. <i>46.03</i>
30.24	<i>Maximum torque 2</i>	<p>Defines the maximum torque limit for the drive (in percent of nominal motor torque) when</p> <ul style="list-style-type: none"> the source selected by parameter <i>30.25 Maximum torque sel</i> is 1, and <i>30.22</i> is set to <i>Maximum torque 2</i>. <p>See diagram at <i>30.18 Minimum torque sel</i>.</p>	300.0%
	0.0 ... 1600.0%	Maximum torque limit 2.	See par. <i>46.03</i>
30.25	<i>Maximum torque sel</i>	<p>Selects a source that switches between two different maximum torque limits.</p> <p>0 = Maximum torque limit 1 defined by <i>30.20</i> is active 1 = Maximum torque limit selected by <i>30.22</i> is active</p> <p>See also parameter <i>30.18 Minimum torque sel</i>.</p>	<i>Maximum torque 1</i>
	Maximum torque 1	0.	0
	Maximum torque 2 source	1.	1
	DI1	Digital input DI1 (<i>10.02 DI delayed status</i> , bit 0).	2

No.	Name/Value	Description	Def/FbEq16
	DI2	Digital input DI2 (10.02 DI delayed status , bit 1).	3
	DI3	Digital input DI3 (10.02 DI delayed status , bit 2).	4
	DI4	Digital input DI4 (10.02 DI delayed status , bit 3).	5
	DI5	Digital input DI5 (10.02 DI delayed status , bit 4).	6
	DI6	Digital input DI6 (10.02 DI delayed status , bit 5).	7
	DIO1	Digital input/output DIO1 (11.02 DIO delayed status , bit 0).	10
	DIO2	Digital input/output DIO2 (11.02 DIO delayed status , bit 1).	11
	<i>Other [bit]</i>	Source selection (see Terms and abbreviations on page 90).	-
30.26	Power motoring limit	Defines the maximum allowed power fed by the inverter to the motor in percent of nominal motor power.	300.00%
	0.00 ... 600.00%	Maximum motoring power.	1 = 1%
30.27	Power generating limit	Defines the maximum allowed power fed by the motor to the inverter in percent of nominal motor power.	-300.00%
	-600.00 ... 0.00%	Maximum generating power.	1 = 1%
30.30	Overvoltage control	Enables the overvoltage control of the intermediate DC link. Fast braking of a high inertia load causes the voltage to rise to the overvoltage control limit. To prevent the DC voltage from exceeding the limit, the overvoltage controller automatically decreases the braking torque. Note: If the drive is equipped with a brake chopper and resistor, or a regenerative supply unit, the controller must be disabled.	Enable
	Disable	Overvoltage control disabled.	0
	Enable	Overvoltage control enabled.	1
30.31	Undervoltage control	Enables the undervoltage control of the intermediate DC link. If the DC voltage drops due to input power cut off, the undervoltage controller will automatically decrease the motor torque in order to keep the voltage above the lower limit. By decreasing the motor torque, the inertia of the load will cause regeneration back to the drive, keeping the DC link charged and preventing an undervoltage trip until the motor coasts to a stop. This will act as a power-loss ride-through functionality in systems with high inertia, such as a centrifuge or a fan.	Enable
	Disable	Undervoltage control disabled.	0
	Enable	Undervoltage control enabled.	1

No.	Name/Value	Description	Def/FbEq16
31 Fault functions			
Configuration of external events; selection of behavior of the drive upon fault situations.			
31.01	External event 1 source	Defines the source of external event 1. See also parameter 31.02 External event 1 type . 0 = Trigger event 1 = Normal operation	<i>Inactive (true)</i> ; <i>DI6 (95.20 b8)</i>
	Active (false)	0.	0
	Inactive (true)	1.	1
	DIIL	DIIL input (<i>10.02 DI delayed status</i> , bit 15).	2
	DI1	Digital input DI1 (<i>10.02 DI delayed status</i> , bit 0).	3
	DI2	Digital input DI2 (<i>10.02 DI delayed status</i> , bit 1).	4
	DI3	Digital input DI3 (<i>10.02 DI delayed status</i> , bit 2).	5
	DI4	Digital input DI4 (<i>10.02 DI delayed status</i> , bit 3).	6
	DI5	Digital input DI5 (<i>10.02 DI delayed status</i> , bit 4).	7
	DI6	Digital input DI6 (<i>10.02 DI delayed status</i> , bit 5).	8
	DIO1	Digital input/output DIO1 (<i>11.02 DIO delayed status</i> , bit 0).	11
	DIO2	Digital input/output DIO2 (<i>11.02 DIO delayed status</i> , bit 1).	12
	<i>Other [bit]</i>	Source selection (see <i>Terms and abbreviations</i> on page 90).	-
31.02	External event 1 type	Selects the type of external event 1.	<i>Fault (95.20 b8)</i>
	Fault	The external event generates a fault.	0
	Warning	The external event generates a warning.	1
	Warning/Fault	If the drive is modulating, the external event generates a fault. Otherwise, the event generates a warning.	3
31.03	External event 2 source	Defines the source of external event 2. See also parameter 31.04 External event 2 type . For the selections, see parameter 31.01 External event 1 source .	<i>Inactive (true)</i> ; <i>DIIL (95.20 b5)</i>
31.04	External event 2 type	Selects the type of external event 2.	
	Fault	The external event generates a fault.	0
	Warning	The external event generates a warning.	1
	Warning/Fault	If the drive is modulating, the external event generates a fault. Otherwise, the event generates a warning.	3

No.	Name/Value	Description	Def/FbEq16
31.05	<i>External event 3 source</i>	Defines the source of external event 3. See also parameter <i>31.06 External event 3 type</i> . For the selections, see parameter <i>31.01 External event 1 source</i> .	<i>Inactive (true)</i>
31.06	<i>External event 3 type</i>	Selects the type of external event 3.	
	Fault	The external event generates a fault.	0
	Warning	The external event generates a warning.	1
	Warning/Fault	If the drive is modulating, the external event generates a fault. Otherwise, the event generates a warning.	3
31.07	<i>External event 4 source</i>	Defines the source of external event 4. See also parameter <i>31.08 External event 4 type</i> . For the selections, see parameter <i>31.01 External event 1 source</i> .	<i>Inactive (true)</i>
31.08	<i>External event 4 type</i>	Selects the type of external event 4.	
	Fault	The external event generates a fault.	0
	Warning	The external event generates a warning.	1
	Warning/Fault	If the drive is modulating, the external event generates a fault. Otherwise, the event generates a warning.	3
31.09	<i>External event 5 source</i>	Defines the source of external event 5. See also parameter <i>31.10 External event 5 type</i> . For the selections, see parameter <i>31.01 External event 1 source</i> .	<i>Inactive (true)</i>
31.10	<i>External event 5 type</i>	Selects the type of external event 5.	
	Fault	The external event generates a fault.	0
	Warning	The external event generates a warning.	1
	Warning/Fault	If the drive is modulating, the external event generates a fault. Otherwise, the event generates a warning.	3
31.11	<i>Fault reset selection</i>	Selects the source of an external fault reset signal. The signal resets the drive after a fault trip if the cause of the fault no longer exists. 0 → 1 = Reset Note: A fault reset from the fieldbus interface is always observed regardless of this parameter.	<i>DI3</i>
	Not selected	0.	0
	Selected	1.	1
	DI1	Digital input DI1 (<i>10.02 DI delayed status</i> , bit 0).	2

No.	Name/Value	Description	Def/FbEq16
	DI2	Digital input DI2 (10.02 DI delayed status , bit 1).	3
	DI3	Digital input DI3 (10.02 DI delayed status , bit 2).	4
	DI4	Digital input DI4 (10.02 DI delayed status , bit 3).	5
	DI5	Digital input DI5 (10.02 DI delayed status , bit 4).	6
	DI6	Digital input DI6 (10.02 DI delayed status , bit 5).	7
	DIO1	Digital input/output DIO1 (11.02 DIO delayed status , bit 0).	10
	DIO2	Digital input/output DIO2 (11.02 DIO delayed status , bit 1).	11
	FBA A MCW bit 7	Control word bit 7 received through fieldbus interface A.	30
	EFB MCW bit 7	Control word bit 7 received through the embedded fieldbus interface.	32
	<i>Other [bit]</i>	Source selection (see Terms and abbreviations on page 90).	-

No.	Name/Value	Description	Def/FbEq16
31.12	<i>Autoreset selection</i>	<p>Selects faults that are automatically reset. The parameter is a 16-bit word with each bit corresponding to a fault type. Whenever a bit is set to 1, the corresponding fault is automatically reset. The number and interval of reset attempts are defined by parameters 31.14...31.16.</p> <p> WARNING! Before you activate the function, make sure that no dangerous situations can occur. The function resets the drive automatically and continues operation after a fault.</p> <p>Note: The autoreset function is only available in external control; see section Local control vs. external control (page 26).</p> <p>The bits of this binary number correspond to the following faults:</p>	0000h

Bit	Fault
0	Overcurrent
1	Overvoltage
2	Undervoltage
3	AI supervision fault
4	Supply unit
5...7	Reserved
8	Application fault 1 (defined in the application program)
9	Application fault 2 (defined in the application program)
10	Selectable fault (see parameter 31.13 User selectable fault)
11	External fault 1 (from source selected by parameter 31.01 External event 1 source)
12	External fault 2 (from source selected by parameter 31.03 External event 2 source)
13	External fault 3 (from source selected by parameter 31.05 External event 3 source)
14	External fault 4 (from source selected by parameter 31.07 External event 4 source)
15	External fault 5 (from source selected by parameter 31.09 External event 5 source)

0000h...FFFFh	Automatic reset configuration word.	1 = 1	
31.13	<i>User selectable fault</i>	<p>Defines the fault that can be automatically reset using parameter 31.12 Autoreset selection, bit 10. The faults are listed in chapter Fault tracing (page 503).</p>	0000h
0000h...FFFFh	Fault code.	10 = 1	

No.	Name/Value	Description	Def/FbEq16
31.14	Number of trials	Defines the maximum number of automatic resets that the drive is allowed to attempt within the time specified by 31.15 Total trials time . If the fault persists, subsequent reset attempts will be made at intervals defined by 31.16 Delay time . The faults to be automatically reset are defined by 31.12 Autoreset selection .	0
	0...5	Number of automatic resets.	-
31.15	Total trials time	Defines a time window for automatic fault resets. The maximum number of attempts made during any period of this length is defined by 31.14 Number of trials . Note: If the fault condition remains and cannot be reset, each reset attempt will generate an event and start a new time window. In practice, if the specified number of resets (31.14) at specified intervals (31.16) take longer than the value of 31.15 , the drive will continue to attempt resetting the fault until the cause is eventually removed.	30.0 s
	1.0 ... 600.0 s	Time for automatic resets.	10 = 1 s
31.16	Delay time	Defines the time that the drive will wait after a fault (or a previous reset attempt) before attempting an automatic reset. See parameter 31.12 Autoreset selection .	0.0 s
	0.0 ... 120.0 s	Autoreset delay.	10 = 1 s
31.19	Motor phase loss	Selects how the drive reacts when a motor phase loss is detected.	<i>Fault</i>
	No action	No action taken.	0
	Fault	The drive trips on fault 3381 Output phase loss .	1
31.20	Earth fault	Selects how the drive reacts when an earth fault or current unbalance is detected in the motor or the motor cable.	<i>Fault</i>
	No action	No action taken.	0
	Warning	The drive generates an A2B3 Earth leakage warning.	1
	Fault	The drive trips on fault 2330 Earth leakage .	2
31.21	Supply phase loss	Selects how the drive reacts when a supply phase loss is detected.	<i>Fault</i>
	No action	No action taken.	0
	Fault	The drive trips on fault 3130 Input phase loss .	1

No.	Name/Value	Description	Def/FbEq16																								
31.22	<i>STO indication run/stop</i>	<p>Selects which indications are given when one or both Safe torque off (STO) signals are switched off or lost. The indications also depend on whether the drive is running or stopped when this occurs.</p> <p>The tables at each selection below show the indications generated with that particular setting.</p> <p>Notes:</p> <ul style="list-style-type: none"> This parameter does not affect the operation of the STO function itself. The STO function will operate regardless of the setting of this parameter: a running drive will stop upon removal of one or both STO signals, and will not start until both STO signals are restored and all faults reset. The loss of only one STO signal always generates a fault as it is interpreted as a malfunction. <p>For more information on the STO, see the <i>Hardware manual</i> of the drive.</p>	<i>Fault/Fault</i>																								
Fault/Fault		<table border="1"> <thead> <tr> <th colspan="2" data-bbox="482 1070 644 1111">Inputs</th> <th data-bbox="644 1070 1182 1128">Indication (running or stopped)</th> </tr> <tr> <th data-bbox="482 1111 561 1151">IN1</th> <th data-bbox="561 1111 644 1151">IN2</th> <th data-bbox="644 1111 1182 1151"></th> </tr> </thead> <tbody> <tr> <td data-bbox="482 1151 561 1191">0</td> <td data-bbox="561 1151 644 1191">0</td> <td data-bbox="644 1151 1182 1191">Fault <i>5091 Safe torque off</i></td> </tr> <tr> <td data-bbox="482 1191 561 1267">0</td> <td data-bbox="561 1191 644 1267">1</td> <td data-bbox="644 1191 1182 1267">Faults <i>5091 Safe torque off</i> and <i>FA81 Safe torque off 1 loss</i></td> </tr> <tr> <td data-bbox="482 1267 561 1344">1</td> <td data-bbox="561 1267 644 1344">0</td> <td data-bbox="644 1267 1182 1344">Faults <i>5091 Safe torque off</i> and <i>FA82 Safe torque off 2 loss</i></td> </tr> <tr> <td data-bbox="482 1344 561 1393">1</td> <td data-bbox="561 1344 644 1393">1</td> <td data-bbox="644 1344 1182 1393">(Normal operation)</td> </tr> </tbody> </table>	Inputs		Indication (running or stopped)	IN1	IN2		0	0	Fault <i>5091 Safe torque off</i>	0	1	Faults <i>5091 Safe torque off</i> and <i>FA81 Safe torque off 1 loss</i>	1	0	Faults <i>5091 Safe torque off</i> and <i>FA82 Safe torque off 2 loss</i>	1	1	(Normal operation)	0						
Inputs		Indication (running or stopped)																									
IN1	IN2																										
0	0	Fault <i>5091 Safe torque off</i>																									
0	1	Faults <i>5091 Safe torque off</i> and <i>FA81 Safe torque off 1 loss</i>																									
1	0	Faults <i>5091 Safe torque off</i> and <i>FA82 Safe torque off 2 loss</i>																									
1	1	(Normal operation)																									
Fault/Warning		<table border="1"> <thead> <tr> <th colspan="2" data-bbox="482 1487 644 1527">Inputs</th> <th colspan="2" data-bbox="644 1487 1182 1527">Indication</th> </tr> <tr> <th data-bbox="482 1527 561 1568">IN1</th> <th data-bbox="561 1527 644 1568">IN2</th> <th data-bbox="644 1527 918 1568">Running</th> <th data-bbox="918 1527 1182 1568">Stopped</th> </tr> </thead> <tbody> <tr> <td data-bbox="482 1568 561 1644">0</td> <td data-bbox="561 1568 644 1644">0</td> <td data-bbox="644 1568 918 1644">Fault <i>5091 Safe torque off</i></td> <td data-bbox="918 1568 1182 1644">Warning <i>A5A0 Safe torque off</i></td> </tr> <tr> <td data-bbox="482 1644 561 1796">0</td> <td data-bbox="561 1644 644 1796">1</td> <td data-bbox="644 1644 918 1796">Faults <i>5091 Safe torque off</i> and <i>FA81 Safe torque off 1 loss</i></td> <td data-bbox="918 1644 1182 1796">Warning <i>A5A0 Safe torque off</i> and fault <i>FA81 Safe torque off 1 loss</i></td> </tr> <tr> <td data-bbox="482 1796 561 1948">1</td> <td data-bbox="561 1796 644 1948">0</td> <td data-bbox="644 1796 918 1948">Faults <i>5091 Safe torque off</i> and <i>FA82 Safe torque off 2 loss</i></td> <td data-bbox="918 1796 1182 1948">Warning <i>A5A0 Safe torque off</i> and fault <i>FA82 Safe torque off 2 loss</i></td> </tr> <tr> <td data-bbox="482 1948 561 1998">1</td> <td data-bbox="561 1948 644 1998">1</td> <td colspan="2" data-bbox="644 1948 1182 1998">(Normal operation)</td> </tr> </tbody> </table>	Inputs		Indication		IN1	IN2	Running	Stopped	0	0	Fault <i>5091 Safe torque off</i>	Warning <i>A5A0 Safe torque off</i>	0	1	Faults <i>5091 Safe torque off</i> and <i>FA81 Safe torque off 1 loss</i>	Warning <i>A5A0 Safe torque off</i> and fault <i>FA81 Safe torque off 1 loss</i>	1	0	Faults <i>5091 Safe torque off</i> and <i>FA82 Safe torque off 2 loss</i>	Warning <i>A5A0 Safe torque off</i> and fault <i>FA82 Safe torque off 2 loss</i>	1	1	(Normal operation)		1
Inputs		Indication																									
IN1	IN2	Running	Stopped																								
0	0	Fault <i>5091 Safe torque off</i>	Warning <i>A5A0 Safe torque off</i>																								
0	1	Faults <i>5091 Safe torque off</i> and <i>FA81 Safe torque off 1 loss</i>	Warning <i>A5A0 Safe torque off</i> and fault <i>FA81 Safe torque off 1 loss</i>																								
1	0	Faults <i>5091 Safe torque off</i> and <i>FA82 Safe torque off 2 loss</i>	Warning <i>A5A0 Safe torque off</i> and fault <i>FA82 Safe torque off 2 loss</i>																								
1	1	(Normal operation)																									

No.	Name/Value	Description	Def/FbEq16																								
	Fault/Event	<table border="1"> <thead> <tr> <th colspan="2">Inputs</th> <th colspan="2">Indication</th> </tr> <tr> <th>IN1</th> <th>IN2</th> <th>Running</th> <th>Stopped</th> </tr> </thead> <tbody> <tr> <td>0</td> <td>0</td> <td>Fault <i>5091 Safe torque off</i></td> <td>Event <i>B5A0 Safe torque off</i></td> </tr> <tr> <td>0</td> <td>1</td> <td>Faults <i>5091 Safe torque off</i> and <i>FA81 Safe torque off 1 loss</i></td> <td>Event <i>B5A0 Safe torque off</i> and fault <i>FA81 Safe torque off 1 loss</i></td> </tr> <tr> <td>1</td> <td>0</td> <td>Faults <i>5091 Safe torque off</i> and <i>FA82 Safe torque off 2 loss</i></td> <td>Event <i>B5A0 Safe torque off</i> and fault <i>FA82 Safe torque off 2 loss</i></td> </tr> <tr> <td>1</td> <td>1</td> <td colspan="2">(Normal operation)</td> </tr> </tbody> </table>	Inputs		Indication		IN1	IN2	Running	Stopped	0	0	Fault <i>5091 Safe torque off</i>	Event <i>B5A0 Safe torque off</i>	0	1	Faults <i>5091 Safe torque off</i> and <i>FA81 Safe torque off 1 loss</i>	Event <i>B5A0 Safe torque off</i> and fault <i>FA81 Safe torque off 1 loss</i>	1	0	Faults <i>5091 Safe torque off</i> and <i>FA82 Safe torque off 2 loss</i>	Event <i>B5A0 Safe torque off</i> and fault <i>FA82 Safe torque off 2 loss</i>	1	1	(Normal operation)		2
Inputs		Indication																									
IN1	IN2	Running	Stopped																								
0	0	Fault <i>5091 Safe torque off</i>	Event <i>B5A0 Safe torque off</i>																								
0	1	Faults <i>5091 Safe torque off</i> and <i>FA81 Safe torque off 1 loss</i>	Event <i>B5A0 Safe torque off</i> and fault <i>FA81 Safe torque off 1 loss</i>																								
1	0	Faults <i>5091 Safe torque off</i> and <i>FA82 Safe torque off 2 loss</i>	Event <i>B5A0 Safe torque off</i> and fault <i>FA82 Safe torque off 2 loss</i>																								
1	1	(Normal operation)																									
	Warning/ Warning	<table border="1"> <thead> <tr> <th colspan="2">Inputs</th> <th rowspan="2">Indication (running or stopped)</th> </tr> <tr> <th>IN1</th> <th>IN2</th> </tr> </thead> <tbody> <tr> <td>0</td> <td>0</td> <td>Warning <i>A5A0 Safe torque off</i></td> </tr> <tr> <td>0</td> <td>1</td> <td>Warning <i>A5A0 Safe torque off</i> and fault <i>FA81 Safe torque off 1 loss</i></td> </tr> <tr> <td>1</td> <td>0</td> <td>Warning <i>A5A0 Safe torque off</i> and fault <i>FA82 Safe torque off 2 loss</i></td> </tr> <tr> <td>1</td> <td>1</td> <td>(Normal operation)</td> </tr> </tbody> </table>	Inputs		Indication (running or stopped)	IN1	IN2	0	0	Warning <i>A5A0 Safe torque off</i>	0	1	Warning <i>A5A0 Safe torque off</i> and fault <i>FA81 Safe torque off 1 loss</i>	1	0	Warning <i>A5A0 Safe torque off</i> and fault <i>FA82 Safe torque off 2 loss</i>	1	1	(Normal operation)	3							
Inputs		Indication (running or stopped)																									
IN1	IN2																										
0	0	Warning <i>A5A0 Safe torque off</i>																									
0	1	Warning <i>A5A0 Safe torque off</i> and fault <i>FA81 Safe torque off 1 loss</i>																									
1	0	Warning <i>A5A0 Safe torque off</i> and fault <i>FA82 Safe torque off 2 loss</i>																									
1	1	(Normal operation)																									
	Event/Event	<table border="1"> <thead> <tr> <th colspan="2">Inputs</th> <th rowspan="2">Indication (running or stopped)</th> </tr> <tr> <th>IN1</th> <th>IN2</th> </tr> </thead> <tbody> <tr> <td>0</td> <td>0</td> <td>Event <i>B5A0 Safe torque off</i></td> </tr> <tr> <td>0</td> <td>1</td> <td>Event <i>B5A0 Safe torque off</i> and fault <i>FA81 Safe torque off 1 loss</i></td> </tr> <tr> <td>1</td> <td>0</td> <td>Event <i>B5A0 Safe torque off</i> and fault <i>FA82 Safe torque off 2 loss</i></td> </tr> <tr> <td>1</td> <td>1</td> <td>(Normal operation)</td> </tr> </tbody> </table>	Inputs		Indication (running or stopped)	IN1	IN2	0	0	Event <i>B5A0 Safe torque off</i>	0	1	Event <i>B5A0 Safe torque off</i> and fault <i>FA81 Safe torque off 1 loss</i>	1	0	Event <i>B5A0 Safe torque off</i> and fault <i>FA82 Safe torque off 2 loss</i>	1	1	(Normal operation)	4							
Inputs		Indication (running or stopped)																									
IN1	IN2																										
0	0	Event <i>B5A0 Safe torque off</i>																									
0	1	Event <i>B5A0 Safe torque off</i> and fault <i>FA81 Safe torque off 1 loss</i>																									
1	0	Event <i>B5A0 Safe torque off</i> and fault <i>FA82 Safe torque off 2 loss</i>																									
1	1	(Normal operation)																									
	No indication/No indication	<table border="1"> <thead> <tr> <th colspan="2">Inputs</th> <th rowspan="2">Indication (running or stopped)</th> </tr> <tr> <th>IN1</th> <th>IN2</th> </tr> </thead> <tbody> <tr> <td>0</td> <td>0</td> <td>None</td> </tr> <tr> <td>0</td> <td>1</td> <td>Fault <i>FA81 Safe torque off 1 loss</i></td> </tr> <tr> <td>1</td> <td>0</td> <td>Fault <i>FA82 Safe torque off 2 loss</i></td> </tr> <tr> <td>1</td> <td>1</td> <td>(Normal operation)</td> </tr> </tbody> </table>	Inputs		Indication (running or stopped)	IN1	IN2	0	0	None	0	1	Fault <i>FA81 Safe torque off 1 loss</i>	1	0	Fault <i>FA82 Safe torque off 2 loss</i>	1	1	(Normal operation)	5							
Inputs		Indication (running or stopped)																									
IN1	IN2																										
0	0	None																									
0	1	Fault <i>FA81 Safe torque off 1 loss</i>																									
1	0	Fault <i>FA82 Safe torque off 2 loss</i>																									
1	1	(Normal operation)																									

No.	Name/Value	Description	Def/FbEq16
31.23	Wiring or earth fault	Selects how the drive reacts to incorrect input power and motor cable connection (i.e. input power cable is connected to drive motor connection). Note: The protection must be disabled with drive/inverter hardware supplied from a common DC bus.	Fault
	No action	No action taken (protection disabled).	0
	Fault	The drive trips on fault 3181 Wiring or earth fault .	1
31.24	Stall function	Selects how the drive reacts to a motor stall condition. A stall condition is defined as follows: <ul style="list-style-type: none"> • The drive exceeds the stall current limit (31.25 Stall current limit), and • the output frequency is below the level set by parameter 31.27 Stall frequency limit or the motor speed is below the level set by parameter 31.26 Stall speed limit, and • the conditions above have been true longer than the time set by parameter 31.28 Stall time. 	Fault
	No action	None (stall supervision disabled).	0
	Warning	The drive generates an A780 Motor stall warning.	1
	Fault	The drive trips on fault 7121 Motor stall .	2
31.25	Stall current limit	Stall current limit in percent of the nominal current of the motor. See parameter 31.24 Stall function .	200.0%
	0.0 ... 1600.0%	Stall current limit.	-
31.26	Stall speed limit	Stall speed limit in rpm. See parameter 31.24 Stall function .	150.00 rpm; 180.00 rpm (95.20 b0)
	0.00 ... 10000.00 rpm	Stall speed limit.	See par. 46.01
31.27	Stall frequency limit	Stall frequency limit. See parameter 31.24 Stall function . Note: Setting the limit below 10 Hz is not recommended.	15.00 Hz; 18.00 Hz (95.20 b0)
	0.00 ... 500.00 Hz	Stall frequency limit.	See par. 46.02
31.28	Stall time	Stall time. See parameter 31.24 Stall function .	20 s
	0 ... 3600 s	Stall time.	-

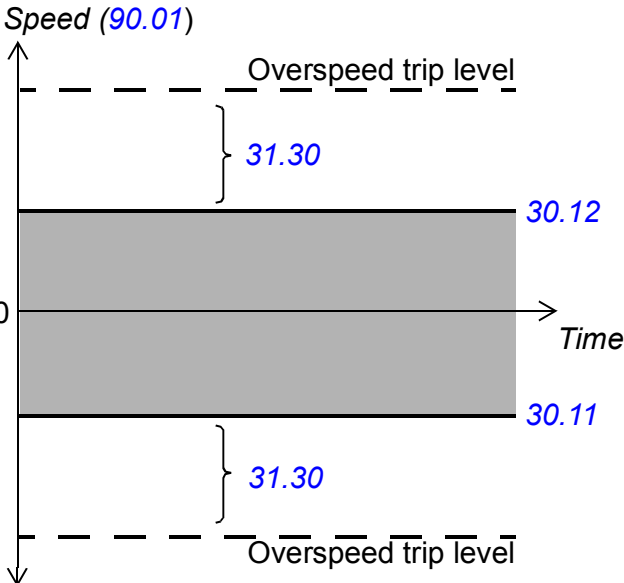
No.	Name/Value	Description	Def/FbEq16
31.30	<i>Overspeed trip margin</i>	<p>Defines, together with 30.11 Minimum speed and 30.12 Maximum speed, the maximum allowed speed of the motor (overspeed protection). If actual speed (90.01 Motor speed for control) exceeds the speed limit defined by parameter 30.11 or 30.12 by more than the value of this parameter, the drive trips on the 7310 Overspeed fault.</p> <p>WARNING! This function only supervises the speed in DTC motor control mode. The function is not effective in scalar motor control mode.</p> <p>Example: If the maximum speed is 1420 rpm and speed trip margin is 300 rpm, the drive trips at 1720 rpm.</p> 	500.00 rpm
	0.00 ... 10000.0 rpm	Overspeed trip margin.	See par. 46.01

No.	Name/Value	Description	Def/FbEq16
31.32	<i>Emergency ramp supervision</i>	<p>Parameters <i>31.32 Emergency ramp supervision</i> and <i>31.33 Emergency ramp supervision delay</i>, together with <i>01.29 Speed change rate</i>, provide a supervision function for emergency stop modes Off1 and Off3.</p> <p>The supervision is based on either</p> <ul style="list-style-type: none"> • observing the time within which the motor stops, or • comparing the actual and expected deceleration rates. <p>If this parameter is set to 0%, the maximum stop time is directly set in parameter <i>31.33</i>. Otherwise, <i>31.32</i> defines the maximum allowed deviation from the expected deceleration rate, which is calculated from parameters <i>23.11...23.19</i> (Off1) or <i>23.23 Emergency stop time</i> (Off3). If the actual deceleration rate (<i>01.29</i>) deviates too much from the expected rate, the drive trips on <i>73B0 Emergency ramp failed</i>, sets bit 8 of <i>06.17 Drive status word 2</i>, and coasts to a stop.</p> <p>If <i>31.32</i> is set to 0% and <i>31.33</i> is set to 0 s, the emergency stop ramp supervision is disabled.</p> <p>See also parameter <i>21.04 Emergency stop mode</i>.</p>	0%
	0...300%	Maximum deviation from expected deceleration rate.	1 = 1%
31.33	<i>Emergency ramp supervision delay</i>	<p>If parameter <i>31.32 Emergency ramp supervision</i> is set to 0%, this parameter defines the maximum time an emergency stop (mode Off1 or Off3) is allowed to take. If the motor has not stopped when the time elapses, the drive trips on <i>73B0 Emergency ramp failed</i>, sets bit 8 of <i>06.17 Drive status word 2</i>, and coasts to a stop.</p> <p>If <i>31.32</i> is set to a value other than 0%, this parameter defines a delay between the receipt of the emergency stop command and the activation of the supervision. It is recommended to specify a short delay to allow the speed change rate to stabilize.</p>	0 s
	0...32767 s	Maximum ramp-down time, or supervision activation delay.	1 = 1 s
31.35	<i>Main fan fault function</i>	Selects how the drive reacts when a main cooling fan fault is detected.	<i>Fault</i>
	Fault	The drive trips on fault <i>5080 Fan</i> .	0
	Warning	The drive generates an <i>A581 Fan</i> warning.	1
	No action	No action taken.	2

No.	Name/Value	Description	Def/Fb/Eq16
31.36	<i>Aux fan fault bypass</i>	<p><i>(Only visible with a ZCU control unit)</i></p> <p>Temporarily suppresses auxiliary fan faults.</p> <p>Certain drive types (especially those protected to IP55) have an auxiliary fan built into the front cover as standard. If the fan is sticking or disconnected, the control program first generates a warning (<i>A582 Auxiliary fan missing</i>), then a fault (<i>5081 Auxiliary fan broken</i>).</p> <p>If it is necessary to operate the drive without the front cover (for example, during commissioning), this parameter can be activated to temporarily suppress the fault.</p> <p>Notes:</p> <ul style="list-style-type: none"> • The parameter must be activated within 2 minutes of control unit reboot (either by cycling the power or by parameter <i>96.08</i>). • The parameter only suppresses the fault, not the warning. • The parameter will be in effect until the auxiliary fan is reconnected and detected, or until the next control unit reboot. 	<i>Off</i>
	Off	Normal operation.	0
	Temporarily bypassed	<p>The auxiliary fan fault indication is temporarily suppressed.</p> <p>The setting will revert automatically to <i>Off</i>.</p>	1

No.	Name/Value	Description	Def/FbEq16
31.37	<i>Ramp stop supervision</i>	<p>Parameters <i>31.37 Ramp stop supervision</i> and <i>31.38 Ramp stop supervision delay</i>, together with <i>01.29 Speed change rate</i>, provide a supervision function for normal (ie. non-emergency) ramp stopping.</p> <p>The supervision is based on either</p> <ul style="list-style-type: none"> • observing the time within which the motor stops, or • comparing the actual and expected deceleration rates. <p>If this parameter is set to 0%, the maximum stop time is directly set in parameter <i>31.38</i>. Otherwise, <i>31.37</i> defines the maximum allowed deviation from the expected deceleration rate, which is calculated from parameters <i>23.11...23.19</i>. If the actual deceleration rate (<i>01.29</i>) deviates too much from the expected rate, the drive trips on <i>73B1 Stop failed</i>, sets bit 14 of <i>06.17 Drive status word 2</i>, and coasts to a stop.</p> <p>If <i>31.32</i> is set to 0% and <i>31.33</i> is set to 0 s, the ramp stop supervision is disabled.</p>	0%
0...300%		Maximum deviation from expected deceleration rate.	1 = 1%
31.38	<i>Ramp stop supervision delay</i>	<p>If parameter <i>31.37 Ramp stop supervision</i> is set to 0%, this parameter defines the maximum time a ramp stop is allowed to take. If the motor has not stopped when the time elapses, the drive trips on <i>73B1 Stop failed</i>, sets bit 14 of <i>06.17 Drive status word 2</i>, and coasts to a stop.</p> <p>If <i>31.37</i> is set to a value other than 0%, this parameter defines a delay between the receipt of the stop command and the activation of the supervision. It is recommended to specify a short delay to allow the speed change rate to stabilize.</p>	0 s
0...32767 s		Maximum ramp-down time, or supervision activation delay.	1 = 1 s

No.	Name/Value	Description	Def/FbEq16												
31.40	<i>Disable warnings</i>	<p>Selects warnings to be suppressed. The parameter is a 16-bit word with each bit corresponding to a warning. Whenever a bit is set to 1, the corresponding warning is suppressed.</p> <p>The bits of this binary number correspond to the following warnings:</p> <table border="1" data-bbox="310 548 1408 795"> <thead> <tr> <th>Bit</th> <th>Fault</th> </tr> </thead> <tbody> <tr> <td>0</td> <td>Overvoltage</td> </tr> <tr> <td>1</td> <td>Reserved</td> </tr> <tr> <td>2</td> <td>Encoder 1</td> </tr> <tr> <td>3</td> <td>Encoder 2</td> </tr> <tr> <td>4...15</td> <td>Reserved</td> </tr> </tbody> </table>	Bit	Fault	0	Overvoltage	1	Reserved	2	Encoder 1	3	Encoder 2	4...15	Reserved	0000b
Bit	Fault														
0	Overvoltage														
1	Reserved														
2	Encoder 1														
3	Encoder 2														
4...15	Reserved														
	0000b...1101b	Warning suppression word.	1 = 1												
31.42	<i>Overcurrent fault limit</i>	<p>Sets a custom motor current fault limit.</p> <p>The drive automatically sets an internal motor current limit according to the drive hardware. The internal limit is appropriate in most cases, but this parameter can be used to set a lower current limit, for example, to protect a permanent magnet motor from demagnetization.</p> <p>With this parameter at 0.0 A, only the internal limit is in force.</p>	-												
	0.0 ... 30000.0 A	Custom motor current fault limit.	See par. 46.05												

No.	Name/Value	Description	Def/FbEq16															
32 Supervision																		
		Configuration of signal supervision functions 1...3. Three values can be chosen to be monitored; a warning or fault is generated whenever predefined limits are exceeded. See also section <i>Signal supervision</i> (page 79).																
32.01	<i>Supervision status</i>	Signal supervision status word. Indicates whether the values monitored by the signal supervision functions are within or outside their respective limits. Note: This word is independent of the drive actions defined by parameters 32.06, 32.16 and 32.26.	0000b															
<table border="1"> <thead> <tr> <th>Bit</th> <th>Name</th> <th>Description</th> </tr> </thead> <tbody> <tr> <td>0</td> <td>Supervision 1 active</td> <td>1 = Signal selected by 32.07 is outside its limits.</td> </tr> <tr> <td>1</td> <td>Supervision 2 active</td> <td>1 = Signal selected by 32.17 is outside its limits.</td> </tr> <tr> <td>2</td> <td>Supervision 3 active</td> <td>1 = Signal selected by 32.27 is outside its limits.</td> </tr> <tr> <td>3...15</td> <td>Reserved</td> <td></td> </tr> </tbody> </table>				Bit	Name	Description	0	Supervision 1 active	1 = Signal selected by 32.07 is outside its limits.	1	Supervision 2 active	1 = Signal selected by 32.17 is outside its limits.	2	Supervision 3 active	1 = Signal selected by 32.27 is outside its limits.	3...15	Reserved	
Bit	Name	Description																
0	Supervision 1 active	1 = Signal selected by 32.07 is outside its limits.																
1	Supervision 2 active	1 = Signal selected by 32.17 is outside its limits.																
2	Supervision 3 active	1 = Signal selected by 32.27 is outside its limits.																
3...15	Reserved																	
0000...0111b		Signal supervision status word.	1 = 1															
32.05	<i>Supervision 1 function</i>	Selects the mode of signal supervision function 1. Determines how the monitored signal (see parameter 32.07) is compared to its lower and upper limits (32.09 and 32.10 respectively). The action to be taken when the condition is fulfilled is selected by 32.06.	<i>Disabled</i>															
Disabled		Signal supervision 1 not in use.	0															
Low		Action is taken whenever the signal falls below its lower limit.	1															
High		Action is taken whenever the signal rises above its upper limit.	2															
Abs low		Action is taken whenever the absolute value of the signal falls below its (absolute) lower limit.	3															
Abs high		Action is taken whenever the absolute value of the signal rises above its (absolute) upper limit.	4															
Both		Action is taken whenever the signal falls below its low limit or rises above its high limit.	5															
Abs both		Action is taken whenever the absolute value of the signal falls below its (absolute) low limit or rises above its (absolute) high limit.	6															

No.	Name/Value	Description	Def/FbEq16
32.06	Supervision 1 action	Selects the action the drive takes when the value monitored by signal supervision 1 exceeds its limits. Note: This parameter does not affect the status indicated by 32.01 Supervision status .	No action
	No action	No action taken.	0
	Warning	A warning (A8B0 Signal supervision) is generated.	1
	Fault	The drive trips on 80B0 Signal supervision .	2
32.07	Supervision 1 signal	Selects the signal to be monitored by signal supervision function 1.	Zero
	Zero	None.	0
	Speed	01.01 Motor speed used (page 94).	1
	Frequency	01.06 Output frequency (page 94).	3
	Current	01.07 Motor current (page 94).	4
	Torque	01.10 Motor torque (page 95).	6
	DC voltage	01.11 DC voltage (page 95).	7
	Output power	01.14 Output power (page 95).	8
	AI1	12.11 AI1 actual value (page 137).	9
	AI2	12.21 AI2 actual value (page 139).	10
	Speed ref ramp in	23.01 Speed ref ramp input (page 209).	18
	Speed ref ramp out	23.02 Speed ref ramp output (page 209).	19
	Speed ref used	24.01 Used speed reference (page 217).	20
	Torque ref used	26.02 Torque reference used (page 234).	21
	Freq ref used	28.02 Frequency ref ramp output (page 243).	22
	Other	Source selection (see Terms and abbreviations on page 90).	-
32.08	Supervision 1 filter time	Defines a filter time constant for the signal monitored by signal supervision 1.	0.000 s
	0.000 ... 30.000 s	Signal filter time.	1000 = 1 s
32.09	Supervision 1 low	Defines the lower limit for signal supervision 1.	0.00
	-21474830.00... 21474830.00	Low limit.	-
32.10	Supervision 1 high	Defines the upper limit for signal supervision 1.	0.00
	-21474830.00... 21474830.00	Upper limit.	-

No.	Name/Value	Description	Def/FbEq16
32.15	<i>Supervision 2 function</i>	Selects the mode of signal supervision function 2. Determines how the monitored signal (see parameter 32.17) is compared to its lower and upper limits (32.19 and 32.20 respectively). The action to be taken when the condition is fulfilled is selected by 32.16.	<i>Disabled</i>
	Disabled	Signal supervision 2 not in use.	0
	Low	Action is taken whenever the signal falls below its lower limit.	1
	High	Action is taken whenever the signal rises above its upper limit.	2
	Abs low	Action is taken whenever the absolute value of the signal falls below its (absolute) lower limit.	3
	Abs high	Action is taken whenever the absolute value of the signal rises above its (absolute) upper limit.	4
	Both	Action is taken whenever the signal falls below its low limit or rises above its high limit.	5
	Abs both	Action is taken whenever the absolute value of the signal falls below its (absolute) low limit or rises above its (absolute) high limit.	6
32.16	<i>Supervision 2 action</i>	Selects the action the drive takes when the value monitored by signal supervision 2 exceeds its limits. Note: This parameter does not affect the status indicated by 32.01 <i>Supervision status</i> .	<i>No action</i>
	No action	No action taken.	0
	Warning	A warning (<i>A8B1 Signal supervision 2</i>) is generated.	1
	Fault	The drive trips on <i>80B1 Signal supervision 2</i> .	2
32.17	<i>Supervision 2 signal</i>	Selects the signal to be monitored by signal supervision function 2. For the available selections, see parameter 32.07 <i>Supervision 1 signal</i> .	<i>Zero</i>
32.18	<i>Supervision 2 filter time</i>	Defines a filter time constant for the signal monitored by signal supervision 2.	0.000 s
	0.000 ... 30.000 s	Signal filter time.	1000 = 1 s
32.19	<i>Supervision 2 low</i>	Defines the lower limit for signal supervision 2.	0.00
	-21474830.00 ... 21474830.00	Low limit.	-

No.	Name/Value	Description	Def/FbEq16
32.20	<i>Supervision 2 high</i>	Defines the upper limit for signal supervision 2.	0.00
	-21474830.00 ... 21474830.00	Upper limit.	-
32.25	<i>Supervision 3 function</i>	Selects the mode of signal supervision function 3. Determines how the monitored signal (see parameter 32.27) is compared to its lower and upper limits (32.29 and 32.30 respectively). The action to be taken when the condition is fulfilled is selected by 32.26.	<i>Disabled</i>
	Disabled	Signal supervision 3 not in use.	0
	Low	Action is taken whenever the signal falls below its lower limit.	1
	High	Action is taken whenever the signal rises above its upper limit.	2
	Abs low	Action is taken whenever the absolute value of the signal falls below its (absolute) lower limit.	3
	Abs high	Action is taken whenever the absolute value of the signal rises above its (absolute) upper limit.	4
	Both	Action is taken whenever the signal falls below its low limit or rises above its high limit.	5
	Abs both	Action is taken whenever the absolute value of the signal falls below its (absolute) low limit or rises above its (absolute) high limit.	6
32.26	<i>Supervision 3 action</i>	Selects the action the drive takes when the value monitored by signal supervision 3 exceeds its limits. Note: This parameter does not affect the status indicated by 32.01 <i>Supervision status</i> .	<i>No action</i>
	No action	No action taken.	0
	Warning	A warning (<i>A8B2 Signal supervision 3</i>) is generated.	1
	Fault	The drive trips on <i>80B2 Signal supervision 3</i> .	2
32.27	<i>Supervision 3 signal</i>	Selects the signal to be monitored by signal supervision function 3. For the available selections, see parameter 32.07 <i>Supervision 1 signal</i> .	<i>Zero</i>
32.28	<i>Supervision 3 filter time</i>	Defines a filter time constant for the signal monitored by signal supervision 3.	0.000 s
	0.000 ... 30.000 s	Signal filter time.	1000 = 1 s

No.	Name/Value	Description	Def/FbEq16
32.29	<i>Supervision 3 low</i>	Defines the lower limit for signal supervision 3.	0.00
	-21474830.00 ... 21474830.00	Low limit.	-
32.30	<i>Supervision 3 high</i>	Defines the upper limit for signal supervision 3.	0.00
	-21474830.00 ... 21474830.00	Upper limit.	-

33 Generic timer & counter	Configuration of maintenance timers/counters. See also section <i>Maintenance timers and counters</i> (page 79).	
---------------------------------------	--	--

33.01	<i>Counter status</i>	Displays the maintenance timer/counter status word, indicating which maintenance timers/counters have exceeded their limits. This parameter is read-only.	-
-------	-----------------------	---	---

Bit	Name	Description
0	On-time1	1 = On-time timer 1 has reached its preset limit.
1	On-time2	1 = On-time timer 2 has reached its preset limit.
2	Edge 1	1 = Signal edge counter 1 has reached its preset limit.
3	Edge 2	1 = Signal edge counter 2 has reached its preset limit.
4	Value 1	1 = Value counter 1 has reached its preset limit.
5	Value 2	1 = Value counter 2 has reached its preset limit.
6...15	Reserved	

	0000 0000b ... 0011 1111b	Maintenance time/counter status word.	1 = 1
--	------------------------------	---------------------------------------	-------

33.10	<i>On-time 1 actual</i>	Displays the actual present value of on-time timer 1. The timer runs whenever the signal selected by parameter <i>33.13 On-time 1 source</i> is on. When the timer exceeds the limit set by <i>33.11 On-time 1 warn limit</i> , bit 0 of <i>33.01 Counter status</i> is set to 1. The warning specified by <i>33.14 On-time 1 warn message</i> is also given if enabled by <i>33.12 On-time 1 function</i> . The timer can be reset from the Drive composer PC tool, or from the control panel by keeping Reset depressed for over 3 seconds.	-
-------	-------------------------	--	---

	0... 4294967295 s	Actual present value of on-time timer 1.	-
--	----------------------	--	---

No.	Name/Value	Description	Def/FbEq16								
33.11	<i>On-time 1 warn limit</i>	Sets the warning limit for on-time timer 1.	0 s								
	0... 4294967295 s	Warning limit for on-time timer 1.	-								
33.12	<i>On-time 1 function</i>	Configures on-time timer 1.	0000b								
<table border="1"> <thead> <tr> <th>Bit</th> <th>Function</th> </tr> </thead> <tbody> <tr> <td>0</td> <td>Counter mode 0 = Loop: When the limit is reached, the counter is reset. The counter status (bit 0 of 33.01) switches to 1 for one second. The warning (if enabled) stays active for at least 10 seconds. 1 = Saturate: When the limit is reached, the counter status (bit 0 of 33.01) switches to 1, and remains so until 33.10 is reset. The warning (if enabled) also stays active until 33.10 is reset.</td> </tr> <tr> <td>1</td> <td>Warning enable 0 = Disable: No warning is given when the limit is reached 1 = Enable: A warning (see 33.14) is given when the limit is reached</td> </tr> <tr> <td>2...15</td> <td>Reserved</td> </tr> </tbody> </table>				Bit	Function	0	Counter mode 0 = Loop: When the limit is reached, the counter is reset. The counter status (bit 0 of 33.01) switches to 1 for one second. The warning (if enabled) stays active for at least 10 seconds. 1 = Saturate: When the limit is reached, the counter status (bit 0 of 33.01) switches to 1, and remains so until 33.10 is reset. The warning (if enabled) also stays active until 33.10 is reset.	1	Warning enable 0 = Disable: No warning is given when the limit is reached 1 = Enable: A warning (see 33.14) is given when the limit is reached	2...15	Reserved
Bit	Function										
0	Counter mode 0 = Loop: When the limit is reached, the counter is reset. The counter status (bit 0 of 33.01) switches to 1 for one second. The warning (if enabled) stays active for at least 10 seconds. 1 = Saturate: When the limit is reached, the counter status (bit 0 of 33.01) switches to 1, and remains so until 33.10 is reset. The warning (if enabled) also stays active until 33.10 is reset.										
1	Warning enable 0 = Disable: No warning is given when the limit is reached 1 = Enable: A warning (see 33.14) is given when the limit is reached										
2...15	Reserved										
	0000b...0011b	On-time timer 1 configuration word.	1 = 1								
33.13	<i>On-time 1 source</i>	Selects the signal to be monitored by on-time timer 1.	<i>False</i>								
	False	Constant 0 (timer disabled).	0								
	True	Constant 1.	1								
	RO1	Bit 0 of 10.21 RO status (page 126).	2								
	<i>Other [bit]</i>	Source selection (see Terms and abbreviations on page 90).	-								
33.14	<i>On-time 1 warn message</i>	Selects the optional warning message for on-time timer 1.	<i>On-time 1 exceeded</i>								
	On-time 1 exceeded	A886 On-time 1 . The message text can be edited on the control panel by choosing Menu – Settings – Edit texts.	0								
	Clean device	A88C Device clean .	6								
	Maintain additional cooling fan	A890 Additional cooling .	7								
	Maintain cabinet fan	A88E Cabinet fan .	8								
	Maintain DC capacitors	A88D DC capacitor .	9								
	Maintain motor bearing	A780 Motor bearing .	10								

No.	Name/Value	Description	Def/FbEq16								
33.20	<i>On-time 2 actual</i>	Displays the actual present value of on-time timer 2. The timer runs whenever the signal selected by parameter <i>33.23 On-time 2 source</i> is on. When the timer exceeds the limit set by <i>33.21 On-time 2 warn limit</i> , bit 1 of <i>33.01 Counter status</i> is set to 1. The warning specified by <i>33.24 On-time 2 warn message</i> is also given if enabled by <i>33.22 On-time 2 function</i> . The timer can be reset from the Drive composer PC tool, or from the control panel by keeping Reset depressed for over 3 seconds.	-								
	0... 4294967295 s	Actual present value of on-time timer 2.	-								
33.21	<i>On-time 2 warn limit</i>	Sets the warning limit for on-time timer 2.	0 s								
	0... 4294967295 s	Warning limit for on-time timer 2.	-								
33.22	<i>On-time 2 function</i>	Configures on-time timer 2.	0000b								
<table border="1"> <thead> <tr> <th>Bit</th> <th>Function</th> </tr> </thead> <tbody> <tr> <td>0</td> <td>Counter mode 0 = Loop: When the limit is reached, the counter is reset. The counter status (bit 1 of <i>33.01</i>) switches to 1 for one second. The warning (if enabled) stays active for at least 10 seconds. 1 = Saturate: When the limit is reached, the counter status (bit 1 of <i>33.01</i>) switches to 1, and remains so until <i>33.20</i> is reset. The warning (if enabled) also stays active until <i>33.20</i> is reset.</td> </tr> <tr> <td>1</td> <td>Warning enable 0 = Disable: No warning is given when the limit is reached 1 = Enable: A warning (see <i>33.24</i>) is given when the limit is reached</td> </tr> <tr> <td>2...15</td> <td>Reserved</td> </tr> </tbody> </table>				Bit	Function	0	Counter mode 0 = Loop: When the limit is reached, the counter is reset. The counter status (bit 1 of <i>33.01</i>) switches to 1 for one second. The warning (if enabled) stays active for at least 10 seconds. 1 = Saturate: When the limit is reached, the counter status (bit 1 of <i>33.01</i>) switches to 1, and remains so until <i>33.20</i> is reset. The warning (if enabled) also stays active until <i>33.20</i> is reset.	1	Warning enable 0 = Disable: No warning is given when the limit is reached 1 = Enable: A warning (see <i>33.24</i>) is given when the limit is reached	2...15	Reserved
Bit	Function										
0	Counter mode 0 = Loop: When the limit is reached, the counter is reset. The counter status (bit 1 of <i>33.01</i>) switches to 1 for one second. The warning (if enabled) stays active for at least 10 seconds. 1 = Saturate: When the limit is reached, the counter status (bit 1 of <i>33.01</i>) switches to 1, and remains so until <i>33.20</i> is reset. The warning (if enabled) also stays active until <i>33.20</i> is reset.										
1	Warning enable 0 = Disable: No warning is given when the limit is reached 1 = Enable: A warning (see <i>33.24</i>) is given when the limit is reached										
2...15	Reserved										
	0000b...0011b	On-time timer 2 configuration word.	1 = 1								
33.23	<i>On-time 2 source</i>	Selects the signal to be monitored by on-time timer 2.	<i>False</i>								
	False	Constant 0 (timer disabled).	0								
	True	Constant 1.	1								
	RO1	Bit 0 of <i>10.21 RO status</i> (page 126).	2								
	<i>Other [bit]</i>	Source selection (see <i>Terms and abbreviations</i> on page 90).	-								

No.	Name/Value	Description	Def/FbEq16
33.24	<i>On-time 2 warn message</i>	Selects the optional warning message for on-time timer 2.	<i>On-time 2 exceeded</i>
	On-time 2 exceeded	<i>A887 On-time 2</i> . The message text can be edited on the control panel by choosing Menu – Settings – Edit texts.	1
	Clean device	<i>A88C Device clean</i> .	6
	Maintain additional cool fan	<i>A890 Additional cooling</i> .	7
	Maintain cabinet fan	<i>A88E Cabinet fan</i> .	8
	Maintain DC capacitors	<i>A88D DC capacitor</i> .	9
	Maintain motor bearing	<i>A780 Motor bearing</i> .	10
33.30	<i>Edge counter 1 actual</i>	Actual present value of signal edge counter 1. The counter is incremented every time the signal selected by parameter <i>33.33 Edge counter 1 source</i> switches on or off (or either, depending on the setting of <i>33.32 Edge counter 1 function</i>). A divisor may be applied to the count (see <i>33.34 Edge counter 1 divider</i>). When the counter exceeds the limit set by <i>33.31 Edge counter 1 warn limit</i> , bit 2 of <i>33.01 Counter status</i> is set to 1. The warning specified by <i>33.35 Edge counter 1 warn message</i> is also given if enabled by <i>33.32 Edge counter 1 function</i> . The counter can be reset from the Drive composer PC tool, or from the control panel by keeping Reset depressed for over 3 seconds.	-
	0...4294967295	Actual present value of signal edge counter 1.	-
33.31	<i>Edge counter 1 warn limit</i>	Sets the warning limit for signal edge counter 1.	0
	0...4294967295	Warning limit for signal edge counter 1.	-

No.	Name/Value	Description	Def/FbEq16												
33.32	<i>Edge counter 1 function</i>	Configures signal edge counter 1.	0000b												
<table border="1"> <thead> <tr> <th>Bit</th> <th>Function</th> </tr> </thead> <tbody> <tr> <td>0</td> <td>Counter mode 0 = Loop: When the limit is reached, the counter is reset. The counter status (bit 2 of 33.01) switches to 1 and remains so until the counter is again incremented. The warning (if enabled) stays active for at least 10 seconds. 1 = Saturate: When the limit is reached, the counter status (bit 2 of 33.01) switches to 1, and remains so until 33.30 is reset. The warning (if enabled) also stays active until 33.30 is reset.</td> </tr> <tr> <td>1</td> <td>Warning enable 0 = Disable: No warning is given when the limit is reached 1 = Enable: A warning (see 33.35) is given when the limit is reached</td> </tr> <tr> <td>2</td> <td>Count rising edges 0 = Disable: Rising edges are not counted 1 = Enable: Rising edges are counted</td> </tr> <tr> <td>3</td> <td>Count falling edges 0 = Disable: Falling edges are not counted 1 = Enable: Falling edges are counted</td> </tr> <tr> <td>4...15</td> <td>Reserved</td> </tr> </tbody> </table>				Bit	Function	0	Counter mode 0 = Loop: When the limit is reached, the counter is reset. The counter status (bit 2 of 33.01) switches to 1 and remains so until the counter is again incremented. The warning (if enabled) stays active for at least 10 seconds. 1 = Saturate: When the limit is reached, the counter status (bit 2 of 33.01) switches to 1, and remains so until 33.30 is reset. The warning (if enabled) also stays active until 33.30 is reset.	1	Warning enable 0 = Disable: No warning is given when the limit is reached 1 = Enable: A warning (see 33.35) is given when the limit is reached	2	Count rising edges 0 = Disable: Rising edges are not counted 1 = Enable: Rising edges are counted	3	Count falling edges 0 = Disable: Falling edges are not counted 1 = Enable: Falling edges are counted	4...15	Reserved
Bit	Function														
0	Counter mode 0 = Loop: When the limit is reached, the counter is reset. The counter status (bit 2 of 33.01) switches to 1 and remains so until the counter is again incremented. The warning (if enabled) stays active for at least 10 seconds. 1 = Saturate: When the limit is reached, the counter status (bit 2 of 33.01) switches to 1, and remains so until 33.30 is reset. The warning (if enabled) also stays active until 33.30 is reset.														
1	Warning enable 0 = Disable: No warning is given when the limit is reached 1 = Enable: A warning (see 33.35) is given when the limit is reached														
2	Count rising edges 0 = Disable: Rising edges are not counted 1 = Enable: Rising edges are counted														
3	Count falling edges 0 = Disable: Falling edges are not counted 1 = Enable: Falling edges are counted														
4...15	Reserved														
	0000b...1111b	Edge counter 1 configuration word.	1 = 1												
33.33	<i>Edge counter 1 source</i>	Selects the signal to be monitored by signal edge counter 1.	<i>False</i>												
	False	Constant 0.	0												
	True	Constant 1.	1												
	RO1	Bit 0 of 10.21 RO status (page 126).	2												
	<i>Other [bit]</i>	Source selection (see Terms and abbreviations on page 90).	-												
33.34	<i>Edge counter 1 divider</i>	Defines a divisor for signal edge counter 1. Determines how many signal edges increment the counter by 1.	1												
	1...4294967295	Divisor for signal edge counter 1.	-												
33.35	<i>Edge counter 1 warn message</i>	Selects the optional warning message for signal edge counter 1.	<i>Edge counter 1 exceeded</i>												
	Edge counter 1 exceeded	A888 Edge counter 1 . The message text can be edited on the control panel by choosing Menu – Settings – Edit texts.	2												
	Counted main contactor	A884 Main contactor .	11												
	Counted output relay	A881 Output relay .	12												

No.	Name/Value	Description	Def/FbEq16
	Counted motor starts	<i>A882 Motor starts.</i>	13
	Counted power ups	<i>A883 Power ups.</i>	14
	Counted DC charges	<i>A885 DC charge.</i>	15
33.40	<i>Edge counter 2 actual</i>	<p>Displays the actual present value of signal edge counter 2.</p> <p>The counter is incremented every time the signal selected by parameter 33.43 Edge counter 2 source switches on or off (or either, depending on the setting of 33.42 Edge counter 2 function). A divisor may be applied to the count (see 33.44 Edge counter 2 divider).</p> <p>When the counter exceeds the limit set by 33.41 Edge counter 2 warn limit, bit 3 of 33.01 Counter status is set to 1. The warning specified by 33.45 Edge counter 2 warn message is also given if enabled by 33.42 Edge counter 2 function.</p> <p>The counter can be reset from the Drive composer PC tool, or from the control panel by keeping Reset depressed for over 3 seconds.</p>	-
	0...4294967295	Actual present value of signal edge counter 2.	-
33.41	<i>Edge counter 2 warn limit</i>	Sets the warning limit for signal edge counter 2.	0
	0...4294967295	Warning limit for signal edge counter 2.	-

No.	Name/Value	Description	Def/FbEq16												
33.42	<i>Edge counter 2 function</i>	Configures signal edge counter 2.	0000b												
<table border="1"> <thead> <tr> <th>Bit</th> <th>Function</th> </tr> </thead> <tbody> <tr> <td>0</td> <td>Counter mode 0 = Loop: When the limit is reached, the counter is reset. The counter status (bit 3 of 33.01) remains 1 until the counter is again incremented. The warning (if enabled) stays active for at least 10 seconds. 1 = Saturate: After the limit is reached, the counter status (bit 3 of 33.01) remains 1 until 33.40 is reset. The warning (if enabled) also stays active until 33.40 is reset.</td> </tr> <tr> <td>1</td> <td>Warning enable 0 = Disable: No warning is given when the limit is reached 1 = Enable: A warning (see 33.45) is given when the limit is reached</td> </tr> <tr> <td>2</td> <td>Count rising edges 0 = Disable: Rising edges are not counted 1 = Enable: Rising edges are counted</td> </tr> <tr> <td>3</td> <td>Count falling edges 0 = Disable: Falling edges are not counted 1 = Enable: Falling edges are counted</td> </tr> <tr> <td>4...15</td> <td>Reserved</td> </tr> </tbody> </table>				Bit	Function	0	Counter mode 0 = Loop: When the limit is reached, the counter is reset. The counter status (bit 3 of 33.01) remains 1 until the counter is again incremented. The warning (if enabled) stays active for at least 10 seconds. 1 = Saturate: After the limit is reached, the counter status (bit 3 of 33.01) remains 1 until 33.40 is reset. The warning (if enabled) also stays active until 33.40 is reset.	1	Warning enable 0 = Disable: No warning is given when the limit is reached 1 = Enable: A warning (see 33.45) is given when the limit is reached	2	Count rising edges 0 = Disable: Rising edges are not counted 1 = Enable: Rising edges are counted	3	Count falling edges 0 = Disable: Falling edges are not counted 1 = Enable: Falling edges are counted	4...15	Reserved
Bit	Function														
0	Counter mode 0 = Loop: When the limit is reached, the counter is reset. The counter status (bit 3 of 33.01) remains 1 until the counter is again incremented. The warning (if enabled) stays active for at least 10 seconds. 1 = Saturate: After the limit is reached, the counter status (bit 3 of 33.01) remains 1 until 33.40 is reset. The warning (if enabled) also stays active until 33.40 is reset.														
1	Warning enable 0 = Disable: No warning is given when the limit is reached 1 = Enable: A warning (see 33.45) is given when the limit is reached														
2	Count rising edges 0 = Disable: Rising edges are not counted 1 = Enable: Rising edges are counted														
3	Count falling edges 0 = Disable: Falling edges are not counted 1 = Enable: Falling edges are counted														
4...15	Reserved														
	0000b...1111b	Edge counter 2 configuration word.	1 = 1												
33.43	<i>Edge counter 2 source</i>	Selects the signal to be monitored by signal edge counter 2.	<i>False</i>												
	False	0.	0												
	True	1.	1												
	RO1	Bit 0 of 10.21 RO status (page 126).	2												
	<i>Other [bit]</i>	Source selection (see Terms and abbreviations on page 90).	-												
33.44	<i>Edge counter 2 divider</i>	Defines a divisor for signal edge counter 2. Determines how many signal edges increment the counter by 1.	1												
	1...4294967295	Divisor for signal edge counter 2.	-												
33.45	<i>Edge counter 2 warn message</i>	Selects the optional warning message for signal edge counter 2.	<i>Edge counter 2 exceeded</i>												
	Edge counter 2 exceeded	A889 Edge counter 2 . The message text can be edited on the control panel by choosing Menu – Settings – Edit texts.	3												
	Counted main contactor	A884 Main contactor .	11												
	Counted output relay	A881 Output relay .	12												

No.	Name/Value	Description	Def/FbEq16
	Counted motor starts	<i>A882 Motor starts.</i>	13
	Counted power ups	<i>A883 Power ups.</i>	14
	Counted DC charges	<i>A885 DC charge.</i>	15
33.50	<i>Value counter 1 actual</i>	<p>Displays the actual present value of value counter 1.</p> <p>The value of the source selected by parameter 33.53 Value counter 1 source is read at one-second intervals and added to the counter. A divisor can be applied to the count (see 33.54 Value counter 1 divider).</p> <p>When the counter exceeds the limit set by 33.51 Value counter 1 warn limit, bit 4 of 33.01 Counter status is set to 1. The warning specified by 33.55 Value counter 1 warn message is also given if enabled by 33.52 Value counter 1 function.</p> <p>The counter can be reset from the Drive composer PC tool, or from the control panel by keeping Reset depressed for over 3 seconds.</p>	-
	-2147483008 ... 2147483008	Actual present value of value counter 1.	-
33.51	<i>Value counter 1 warn limit</i>	<p>Sets the limit for value counter 1.</p> <p>With a positive limit, bit 4 of 33.01 Counter status is set to 1 (and a warning optionally generated) when the counter is equal or greater than the limit.</p> <p>With a negative limit, bit 4 of 33.01 Counter status is set to 1 (and a warning optionally generated) when the counter is equal or smaller than the limit.</p> <p>0 = Counter disabled.</p>	0
	-2147483008 ... 2147483008	Limit for value counter 1.	-

No.	Name/Value	Description	Def/FbEq16								
33.52	<i>Value counter 1 function</i>	Configures value counter 1.	0000b								
<table border="1"> <thead> <tr> <th>Bit</th> <th>Function</th> </tr> </thead> <tbody> <tr> <td>0</td> <td>Counter mode 0 = Loop: When the limit is reached, the counter is reset. The counter status (bit 4 of 33.01) switches to 1 for one second. The warning (if enabled) stays active for at least 10 seconds. 1 = Saturate: When the limit is reached, the counter status (bit 4 of 33.01) switches to 1, and remains so until 33.50 is reset. The warning (if enabled) also stays active until 33.50 is reset.</td> </tr> <tr> <td>1</td> <td>Warning enable 0 = Disable: No warning is given when the limit is reached 1 = Enable: A warning (see 33.55) is given when the limit is reached</td> </tr> <tr> <td>2...15</td> <td>Reserved</td> </tr> </tbody> </table>				Bit	Function	0	Counter mode 0 = Loop: When the limit is reached, the counter is reset. The counter status (bit 4 of 33.01) switches to 1 for one second. The warning (if enabled) stays active for at least 10 seconds. 1 = Saturate: When the limit is reached, the counter status (bit 4 of 33.01) switches to 1, and remains so until 33.50 is reset. The warning (if enabled) also stays active until 33.50 is reset.	1	Warning enable 0 = Disable: No warning is given when the limit is reached 1 = Enable: A warning (see 33.55) is given when the limit is reached	2...15	Reserved
Bit	Function										
0	Counter mode 0 = Loop: When the limit is reached, the counter is reset. The counter status (bit 4 of 33.01) switches to 1 for one second. The warning (if enabled) stays active for at least 10 seconds. 1 = Saturate: When the limit is reached, the counter status (bit 4 of 33.01) switches to 1, and remains so until 33.50 is reset. The warning (if enabled) also stays active until 33.50 is reset.										
1	Warning enable 0 = Disable: No warning is given when the limit is reached 1 = Enable: A warning (see 33.55) is given when the limit is reached										
2...15	Reserved										
	0000b...0011b	Value counter 1 configuration word.	1 = 1								
33.53	<i>Value counter 1 source</i>	Selects the signal to be monitored by value counter 1.	<i>Not selected</i>								
	Not selected	None (counter disabled).	0								
	Motor speed	01.01 Motor speed used (see page 94).	1								
	<i>Other</i>	Source selection (see Terms and abbreviations on page 90).	-								
33.54	<i>Value counter 1 divider</i>	Defines a divisor for value counter 1. The value of the monitored signal is divided by this value before integration.	1.000								
	0.001 ... 2147483.000	Divisor for value counter 1.	-								
33.55	<i>Value counter 1 warn message</i>	Selects the optional warning message for value counter 1.	<i>Value counter 1 exceeded</i>								
	Value counter 1 exceeded	A88A Value counter 1 . The message text can be edited on the control panel by choosing Menu – Settings – Edit texts.	4								
	Maintain motor bearing	A780 Motor bearing .	10								

No.	Name/Value	Description	Def/FbEq16								
33.60	<i>Value counter 2 actual</i>	<p>Displays the actual present value of value counter 2.</p> <p>The value of the source selected by parameter 33.63 Value counter 2 source is read at one-second intervals and added to the counter. A divisor can be applied to the count (see 33.64 Value counter 2 divider).</p> <p>When the counter exceeds the limit set by 33.61 Value counter 2 warn limit, bit 5 of 33.01 Counter status is set to 1. The warning specified by 33.65 Value counter 2 warn message is also given if enabled by 33.62 Value counter 2 function.</p> <p>The counter can be reset from the Drive composer PC tool, or from the control panel by keeping Reset depressed for over 3 seconds.</p>	-								
	-2147483008 ... 2147483008	Actual present value of value counter 2.	-								
33.61	<i>Value counter 2 warn limit</i>	<p>Sets the limit for value counter 2.</p> <p>With a positive limit, bit 5 of 33.01 Counter status is set to 1 (and a warning optionally generated) when the counter is equal or greater than the limit.</p> <p>With a negative limit, bit 5 of 33.01 Counter status is set to 1 (and a warning optionally generated) when the counter is equal or smaller than the limit.</p> <p>0 = Counter disabled.</p>	0								
	-2147483008 ... 2147483008	Limit for value counter 2.	-								
33.62	<i>Value counter 2 function</i>	Configures value counter 2.	0000b								
<table border="1"> <thead> <tr> <th>Bit</th> <th>Function</th> </tr> </thead> <tbody> <tr> <td>0</td> <td> <p>Counter mode</p> <p>0 = Loop: When the limit is reached, the counter is reset. The counter status (bit 5 of 33.01) switches to 1 for one second. The warning (if enabled) stays active for at least 10 seconds.</p> <p>1 = Saturate: When the limit is reached, the counter status (bit 5 of 33.01) switches to 1, and remains so until 33.60 is reset. The warning (if enabled) also stays active until 33.60 is reset.</p> </td> </tr> <tr> <td>1</td> <td> <p>Warning enable</p> <p>0 = Disable: No warning is given when the limit is reached</p> <p>1 = Enable: A warning (see 33.65) is given when the limit is reached</p> </td> </tr> <tr> <td>2...15</td> <td>Reserved</td> </tr> </tbody> </table>				Bit	Function	0	<p>Counter mode</p> <p>0 = Loop: When the limit is reached, the counter is reset. The counter status (bit 5 of 33.01) switches to 1 for one second. The warning (if enabled) stays active for at least 10 seconds.</p> <p>1 = Saturate: When the limit is reached, the counter status (bit 5 of 33.01) switches to 1, and remains so until 33.60 is reset. The warning (if enabled) also stays active until 33.60 is reset.</p>	1	<p>Warning enable</p> <p>0 = Disable: No warning is given when the limit is reached</p> <p>1 = Enable: A warning (see 33.65) is given when the limit is reached</p>	2...15	Reserved
Bit	Function										
0	<p>Counter mode</p> <p>0 = Loop: When the limit is reached, the counter is reset. The counter status (bit 5 of 33.01) switches to 1 for one second. The warning (if enabled) stays active for at least 10 seconds.</p> <p>1 = Saturate: When the limit is reached, the counter status (bit 5 of 33.01) switches to 1, and remains so until 33.60 is reset. The warning (if enabled) also stays active until 33.60 is reset.</p>										
1	<p>Warning enable</p> <p>0 = Disable: No warning is given when the limit is reached</p> <p>1 = Enable: A warning (see 33.65) is given when the limit is reached</p>										
2...15	Reserved										
	0000b...0011b	Value counter 2 configuration word.	1 = 1								

No.	Name/Value	Description	Def/FbEq16
33.63	Value counter 2 source	Selects the signal to be monitored by value counter 2.	Not selected
	Not selected	None (counter disabled).	0
	Motor speed	01.01 Motor speed used (see page 94).	1
	Other	Source selection (see Terms and abbreviations on page 90).	-
33.64	Value counter 2 divider	Defines a divisor for value counter 2. The value of the monitored signal is divided by this value before integration.	1.000
	0.001 ... 2147483.000	Divisor for value counter 2.	-
33.65	Value counter 2 warn message	Selects the optional warning message for value counter 2.	Value counter 2 exceeded
	Value counter 2 exceeded	A88B Value counter 2 . The message text can be edited on the control panel by choosing Menu – Settings – Edit texts.	5
	Maintain motor bearing	A780 Motor bearing .	10
35 Motor thermal protection		Motor thermal protection settings such as temperature measurement configuration, load curve definition and motor fan control configuration. See also section Motor thermal protection (page 73).	
35.01	Motor estimated temperature	Displays the motor temperature as estimated by the internal motor thermal protection model (see parameters 35.50...35.55). The unit is selected by parameter 96.16 Unit selection This parameter is read-only.	-
	-60 ... 1000 °C or °F	Estimated motor temperature.	1 = 1°
35.02	Measured temperature 1	Displays the temperature received through the source defined by parameter 35.11 Temperature 1 source . The unit is selected by parameter 96.16 Unit selection . Note: With a PTC sensor, the unit is ohms. This parameter is read-only.	-
	-60 ... 5000 °C, -76 ... 9032 °F, 0 ohm or [35.12] ohm	Measured temperature 1.	1 = 1 unit

No.	Name/Value	Description	Def/FbEq16
35.03	<i>Measured temperature 2</i>	Displays the temperature received through the source defined by parameter 35.21 Temperature 2 source . The unit is selected by parameter 96.16 Unit selection . Note: With a PTC sensor, the unit is ohms. This parameter is read-only.	-
	-60 ... 5000 °C, -76 ... 9032 °F, 0 ohm or [35.22] ohm	Measured temperature 2.	1 = 1 unit
35.11	<i>Temperature 1 source</i>	Selects the source from which measured temperature 1 is read. For wiring examples, see the hardware manual of the drive. Usually this source is from a sensor connected to the motor controlled by the drive, but it could be used to measure and monitor a temperature from other parts of the process as long as a suitable sensor is used as per the selection list.	<i>Disabled</i>
	Disabled	None. Temperature monitoring function 1 is disabled.	0
	Estimated temperature	Estimated motor temperature (see parameter 35.01 Motor estimated temperature). The temperature is estimated from an internal drive calculation. It is important to set up the ambient temperature of the motor in 35.50 Motor ambient temperature .	1

No.	Name/Value	Description	Def/FbEq16
	KTY84 analog I/O	<p>KTY84 sensor connected to the analog input selected by parameter 35.14 Temperature 1 AI source and an analog output. The input and output can be on the drive control unit or on an extension module.</p> <p>The following settings are required:</p> <ul style="list-style-type: none"> • Set the hardware jumper or switch related to the analog input to U (voltage). Any change must be validated by a control unit reboot. • Set the unit selection parameter of the input to volt. • Set the source selection parameter of the analog output to “Force KTY84 excitation”. • Select the analog input in parameter 35.14. In case the input is located on an I/O extension module, use the selection Other to point at the actual input value parameter (for example, 14.26 AI1 actual value). <p>The analog output feeds a constant current through the sensor. As the resistance of the sensor changes along with its temperature, the voltage over the sensor changes. The voltage is read by the analog input and converted into degrees.</p>	2
	KTY84 encoder module 1	<p>KTY84 sensor connected to encoder interface 1. See also parameters 91.21 Module 1 temp sensor type and 91.22 Module 1 temp filter time.</p>	3
	KTY84 encoder module 2	<p>KTY84 sensor connected to encoder interface 2. See also parameters 91.24 Module 2 temp sensor type and 91.25 Module 2 temp filter time.</p>	4
	1 × Pt100 analog I/O	<p>Pt100 sensor connected to a standard analog input selected by parameter 35.14 Temperature 1 AI source and an analog output. The input and output can be on the drive control unit or on an extension module.</p> <p>The required settings are the same as with selection KTY84 analog I/O, except that the source selection parameter of the analog output must be set to Force Pt100 excitation.</p>	5
	2 × Pt100 analog I/O	<p>As selection 1 × Pt100 analog I/O, but with two sensors connected in series. Using multiple sensors improves measurement accuracy significantly.</p>	6
	3 × Pt100 analog I/O	<p>As selection 1 × Pt100 analog I/O, but with three sensors connected in series. Using multiple sensors improves measurement accuracy significantly.</p>	7

No.	Name/Value	Description	Def/FbEq16
	PTC DI6	PTC sensor connected to digital input DI6 (see the connection diagram on page 73). Note: Either 0 ohm (normal temperature) or 4000 ohm (excessive temperature) will be shown by 35.02 Measured temperature 1 .	8
	PTC analog I/O	PTC sensor connected to a standard analog input selected by parameter 35.14 Temperature 1 AI source and an analog output. The input and output can be on the drive control unit or on an extension module. The required settings are the same as with selection KTY84 analog I/O , except that the source selection parameter of the analog output must be set to Force PTC excitation . Note: Either 0 ohm (normal temperature) or 4000 ohm (excessive temperature) will be shown by 35.02 Measured temperature 1 .	20
	PTC encoder module 1	PTC sensor connected to encoder interface 1. See also parameters 91.21 Module 1 temp sensor type and 91.22 Module 1 temp filter time .	9
	PTC encoder module 2	PTC sensor connected to encoder interface 2. See also parameters 91.24 Module 2 temp sensor type and 91.25 Module 2 temp filter time .	10
	Direct temperature	The temperature is taken from the source selected by parameter 35.14 Temperature 1 AI source . The value of the source is assumed to be in the unit of temperature specified by 96.16 Unit selection .	11
	1 × Pt1000 analog I/O	Pt1000 sensor connected to a standard analog input selected by parameter 35.14 Temperature 1 AI source and an analog output. The input and output can be on the drive control unit or on an extension module. The required settings are the same as with selection KTY84 analog I/O , except that the source selection parameter of the analog output must be set to Force Pt1000 excitation .	13
	2 × Pt1000 analog I/O	As selection 1 × Pt1000 analog I/O , but with two sensors connected in series. Using multiple sensors improves measurement accuracy significantly.	14
	3 × Pt1000 analog I/O	As selection 1 × Pt1000 analog I/O , but with three sensors connected in series. Using multiple sensors improves measurement accuracy significantly.	15

No.	Name/Value	Description	Def/FbEq16
35.12	<i>Temperature 1 fault limit</i>	Defines the fault limit for temperature monitoring function 1. When measured temperature 1 exceeds the limit, the drive trips on fault <i>4981 External temperature 1</i> . The unit is selected by parameter <i>96.16 Unit selection</i> . Note: With a PTC sensor, the unit is ohms.	130 °C or 266 °F
	-60 ... 5000 °C or ohm, or -76 ... 1832 °F	Fault limit for temperature monitoring function 1.	1 = 1 unit
35.13	<i>Temperature 1 warning limit</i>	Defines the warning limit for temperature monitoring function 1. When measured temperature 1 exceeds this limit, a warning (<i>A491 External temperature 1</i>) is generated. The unit is selected by parameter <i>96.16 Unit selection</i> . Note: With a PTC sensor, the unit is ohms.	110 °C or 230 °F
	-60 ... 5000 °C or ohm, or -76 ... 9032 °F	Warning limit for temperature monitoring function 1.	1 = 1 unit
35.14	<i>Temperature 1 AI source</i>	Specifies the analog input when the setting of <i>35.11 Temperature 1 source</i> requires measurement through an analog input. Note: If the input is located on an I/O extension module, use the selection <i>Other</i> to point to the AI actual value in group 14, 15 or 16, eg. <i>14.26 AI1 actual value</i> .	<i>Not selected</i>
	Not selected	None.	0
	AI1 actual value	Analog input AI1 on the control unit.	1
	AI2 actual value	Analog input AI2 on the control unit.	2
	<i>Other</i>	Source selection (see <i>Terms and abbreviations</i> on page 90).	-
35.21	<i>Temperature 2 source</i>	Selects the source from which measured temperature 2 is read. For wiring examples, see the hardware manual of the drive. Usually this source is from a sensor connected to the motor controlled by the drive, but it could be used to measure and monitor a temperature from other parts of the process as long as a suitable sensor is used as per the selection list.	<i>Disabled</i>
	Disabled	None. Temperature monitoring function 2 is disabled.	0

No.	Name/Value	Description	Def/Fb/Eq16
	Estimated temperature	<p>Estimated motor temperature (see parameter 35.01 Motor estimated temperature).</p> <p>The temperature is estimated from an internal drive calculation. It is important to set up the ambient temperature of the motor in 35.50 Motor ambient temperature.</p>	1
	KTY84 analog I/O	<p>KTY84 sensor connected to the analog input selected by parameter 35.24 Temperature 2 AI source and an analog output. The input and output can be on the drive control unit or on an extension module.</p> <p>The following settings are required:</p> <ul style="list-style-type: none"> • Set the hardware jumper or switch related to the analog input to U (voltage). Any change must be validated by a control unit reboot. • Set the unit selection parameter of the input to volt. • Set the source selection parameter of the analog output to "Force KTY84 excitation". • Select the analog input in parameter 35.24. In case the input is located on an I/O extension module, use the selection Other to point at the actual input value parameter (for example, 14.26 AI1 actual value). <p>The analog output feeds a constant current through the sensor. As the resistance of the sensor changes along with its temperature, the voltage over the sensor changes. The voltage is read by the analog input and converted into degrees.</p>	2
	KTY84 encoder module 1	<p>KTY84 sensor connected to encoder interface 1.</p> <p>See also parameters 91.21 Module 1 temp sensor type and 91.22 Module 1 temp filter time.</p>	3
	KTY84 encoder module 2	<p>KTY84 sensor connected to encoder interface 2.</p> <p>See also parameters 91.24 Module 2 temp sensor type and 91.25 Module 2 temp filter time.</p>	4
	1 × Pt100 analog I/O	<p>Pt100 sensor connected to a standard analog input selected by parameter 35.24 Temperature 2 AI source and an analog output. The input and output can be on the drive control unit or on an extension module.</p> <p>The required settings are the same as with selection KTY84 analog I/O, except that the source selection parameter of the analog output must be set to Force Pt100 excitation.</p>	5

No.	Name/Value	Description	Def/FbEq16
	2 × Pt100 analog I/O	As selection 1 × Pt100 analog I/O , but with two sensors connected in series. Using multiple sensors improves measurement accuracy significantly.	6
	3 × Pt100 analog I/O	As selection 1 × Pt100 analog I/O , but with three sensors connected in series. Using multiple sensors improves measurement accuracy significantly.	7
	PTC DI6	PTC sensor connected to digital input DI6 (see the connection diagram on page 73). Note: Either 0 ohm (normal temperature) or 4000 ohm (excessive temperature) will be shown by 35.03 Measured temperature 2 .	8
	PTC analog I/O	PTC sensor connected to a standard analog input selected by parameter 35.24 Temperature 2 AI source and an analog output. The input and output can be on the drive control unit or on an extension module. The required settings are the same as with selection KTY84 analog I/O , except that the source selection parameter of the analog output must be set to Force PTC excitation . Note: Either 0 ohm (normal temperature) or 4000 ohm (excessive temperature) will be shown by 35.03 Measured temperature 2 .	20
	PTC encoder module 1	PTC sensor connected to encoder interface 1. See also parameters 91.21 Module 1 temp sensor type and 91.22 Module 1 temp filter time .	9
	PTC encoder module 2	PTC sensor connected to encoder interface 2. See also parameters 91.24 Module 2 temp sensor type and 91.25 Module 2 temp filter time .	10
	Direct temperature	The temperature is taken from the source selected by parameter 35.24 Temperature 2 AI source . The value of the source is assumed to be in the unit of temperature specified by 96.16 Unit selection .	11
	1 × Pt1000 analog I/O	Pt1000 sensor connected to a standard analog input selected by parameter 35.24 Temperature 2 AI source and an analog output. The input and output can be on the drive control unit or on an extension module. The required settings are the same as with selection KTY84 analog I/O , except that the source selection parameter of the analog output must be set to Force Pt1000 excitation .	13

No.	Name/Value	Description	Def/FbEq16
	2 × Pt1000 analog I/O	As selection 1 × Pt1000 analog I/O , but with two sensors connected in series. Using multiple sensors improves measurement accuracy significantly.	14
	3 × Pt1000 analog I/O	As selection 1 × Pt1000 analog I/O , but with three sensors connected in series. Using multiple sensors improves measurement accuracy significantly.	15
35.22	Temperature 2 fault limit	Defines the fault limit for temperature monitoring function 2. When measured temperature 2 exceeds the limit, the drive trips on fault 4982 External temperature 2 . The unit is selected by parameter 96.16 Unit selection . Note: With a PTC sensor, the unit is ohms.	130 °C or 266 °F
	-60 ... 5000 °C or -76 ... 9032 °F	Fault limit for temperature monitoring function 2.	1 = 1 unit
35.23	Temperature 2 warning limit	Defines the warning limit for temperature monitoring function 2. When measured temperature 2 exceeds the limit, a warning (A492 External temperature 2) is generated. The unit is selected by parameter 96.16 Unit selection . Note: With a PTC sensor, the unit is ohms.	110 °C or 230 °F
	-60 ... 5000 °C or -76 ... 9032 °F	Warning limit for temperature monitoring function 2.	1 = 1 unit
35.24	Temperature 2 AI source	Selects the input for parameter 35.21 Temperature 2 source , selections KTY84 analog I/O , 1 × Pt100 analog I/O , 2 × Pt100 analog I/O , 3 × Pt100 analog I/O and Direct temperature .	<i>Not selected</i>
	Not selected	None.	0
	AI1 actual value	Analog input AI1 on the control unit.	1
	AI2 actual value	Analog input AI2 on the control unit.	2
	Other	Source selection (see Terms and abbreviations on page 90).	-

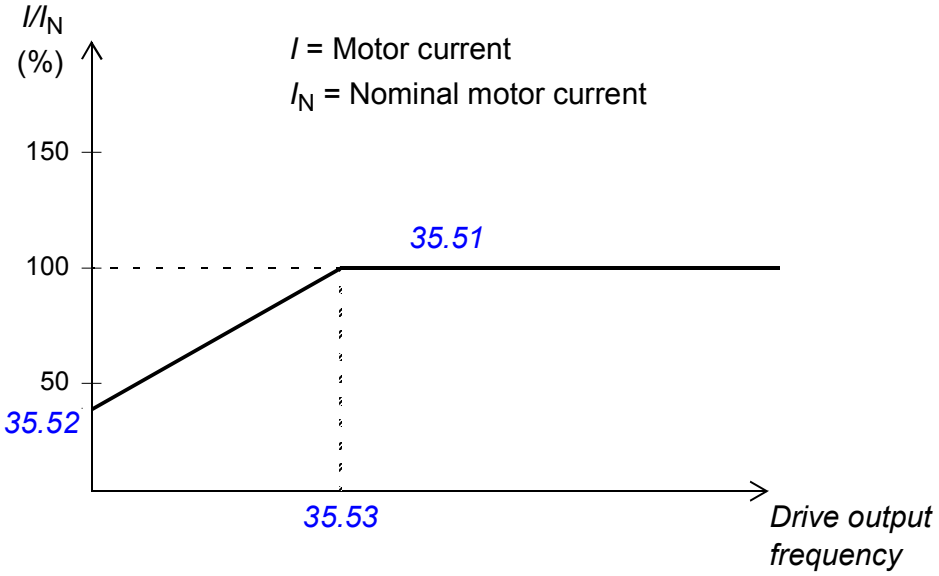
No.	Name/Value	Description	Def/FbEq16
35.50	<i>Motor ambient temperature</i>	<p>Defines the ambient temperature of the motor for the motor thermal protection model. The unit is selected by parameter 96.16 Unit selection.</p> <p>The motor thermal protection model estimates the motor temperature on the basis of parameters 35.50...35.55. The motor temperature increases if it operates in the region above the load curve, and decreases if it operates in the region below the load curve.</p> <p> WARNING! The model cannot protect the motor if the motor does not cool properly because of dust, dirt, etc.</p>	20 °C or 68 °F
	-60 ... 100 °C or -75 ... 212 °F	Ambient temperature.	1 = 1°
35.51	<i>Motor load curve</i>	<p>Defines the motor load curve together with parameters 35.52 Zero speed load and 35.53 Break point. The load curve is used by the motor thermal protection model to estimate the motor temperature.</p> <p>When the parameter is set to 100%, the maximum load is taken as the value of parameter 99.06 Motor nominal current (higher loads heat up the motor). The load curve level should be adjusted if the ambient temperature differs from the nominal value set in 35.50 Motor ambient temperature.</p>	100%
<div style="text-align: center;">  <p>I/I_N (%)</p> <p>I = Motor current I_N = Nominal motor current</p> <p>150</p> <p>100</p> <p>50</p> <p>35.52</p> <p>35.53</p> <p>35.51</p> <p>Drive output frequency</p> </div>			
	50 ... 150%	Maximum load for the motor load curve.	1 = 1%

No.	Name/Value	Description	Def/FbEq16
35.52	<i>Zero speed load</i>	<p>Defines the motor load curve together with parameters 35.51 Motor load curve and 35.53 Break point. Defines the maximum motor load at zero speed of the load curve. A higher value can be used if the motor has an external motor fan to boost the cooling. See the motor manufacturer's recommendations.</p> <p>See parameter 35.51 Motor load curve.</p>	100%
	50 ... 150%	Zero speed load for the motor load curve.	1 = 1%
35.53	<i>Break point</i>	<p>Defines the motor load curve together with parameters 35.51 Motor load curve and 35.52 Zero speed load. Defines the break point frequency of the load curve i.e. the point at which the motor load curve begins to decrease from the value of parameter 35.51 Motor load curve towards the value of parameter 35.52 Zero speed load.</p> <p>See parameter 35.51 Motor load curve.</p>	45.00 Hz
	1.00 ... 500.00 Hz	Break point for the motor load curve.	See par. 46.02
35.54	<i>Motor nominal temperature rise</i>	<p>Defines the temperature rise of the motor above ambient when the motor is loaded with nominal current. See the motor manufacturer's recommendations.</p> <p>The unit is selected by parameter 96.16 Unit selection.</p>	80 °C or 176 °F
	0...300 °C or 32...572 °F	Temperature rise.	1 = 1°

No.	Name/Value	Description	Def/FbEq16
35.55	<i>Motor thermal time constant</i>	Defines the thermal time constant for use with the motor thermal protection model, defined as the time to reach 63% of the nominal motor temperature. See the motor manufacturer's recommendations.	256 s
<p>The figure consists of two vertically aligned graphs sharing a common horizontal time axis. The top graph, titled 'Motor current', shows a square pulse that rises to 100% and then falls back to 0%. The bottom graph, titled 'Temperature rise', shows a curve that starts at 0% at the beginning of the current pulse, rises to 63% at the end of the pulse, reaches a peak of 100% during the pulse, and then decays back to 0% after the pulse ends. A horizontal bracket under the 63% mark on the temperature rise curve is labeled 'Motor thermal time'.</p>			
100 ... 10000 s		Motor thermal time constant.	1 = 1 s
35.60	<i>Cable temperature</i>	Shows the calculated temperature of the motor cable. See section <i>Thermal protection of motor cable</i> (page 76). 102% = overtemperature warning (<i>A480 Motor cable overload</i>) 106% = overtemperature fault (<i>4000 Motor cable overload</i>) This parameter is read-only.	0.0%
0.0 ... 200.0%		Calculated temperature of motor cable.	1 = 1%
35.61	<i>Cable nominal current</i>	Specifies the continuous current of the motor cable for the thermal protection function in the control program. ⚠ WARNING! The value entered in this parameter must be limited according to all factors affecting the loadability of the cable, such as ambient temperature, cabling arrangement, and shrouding. Refer to the technical data from the cable manufacturer.	10000.00 A
0.00 ... 10000.00 A		Continuous current-carrying capacity of motor cable.	1 = 1 A

No.	Name/Value	Description	Def/FbEq16
35.62	Cable thermal rise time	<p>Specifies the thermal time of the motor cable for the thermal protection function in the control program. This value is defined as the time to reach 63% of the nominal cable temperature when the cable is loaded with nominal current (parameter 35.61 Cable nominal current).</p> <p>0 s = Thermal protection of motor cable disabled</p> <p>Refer to the technical data from the cable manufacturer.</p>	1 s
0 s		Thermal protection of motor cable disabled.	1 = 1 s
1...50000 s		Motor cable thermal time constant.	1 = 1 s
35.100	DOL starter control source	<p>Parameters 35.100...35.106 configure a monitored start/stop control logic for external equipment such as a contactor-controlled motor cooling fan.</p> <p>This parameter selects the signal that starts and stops the fan.</p> <p>0 = Stop 1 = Start</p> <p>The output controlling the fan contactor is to be connected to parameter 35.105, bit 1. On and off delays can be set for the fan by 35.101 and 35.102 respectively. A feedback signal from the fan can be connected to an input selected by 35.103; the loss of the feedback will optionally trigger a warning or fault (see 35.104 and 35.106).</p>	Off, 06.16 b6 (95.20 b6)
Off		0 (function disabled).	0
On		1.	1

No.	Name/Value	Description	Def/FbEq16
	Running	Bit 6 of <i>06.16 Drive status word 1</i> (see page 109).	2
	<i>Other [bit]</i>	Source selection (see <i>Terms and abbreviations</i> on page 90).	-
35.101	<i>DOL starter on delay</i>	Defines a start delay for the motor fan. The delay timer starts when the control source selected by parameter 35.100 switches on. After the delay, bit 1 of 35.105 switches on.	0 s
	0...42949673 s	Motor fan start delay.	1 = 1 s
35.102	<i>DOL starter off delay</i>	Defines a stop delay for the motor fan. The delay timer starts when the control source selected by parameter 35.100 switches off. After the delay, bit 1 of 35.105 switches off.	20 min
	0...715828 min	Motor fan stop delay.	1 = 1 min
35.103	<i>DOL starter feedback source</i>	Selects the input for motor fan feedback signal. 0 = Stopped 1 = Running After the fan is started (bit 1 of 35.105 switches on), feedback is expected within the time set by 35.104 .	<i>Not selected;</i> <i>DI5</i> <i>(95.20 b6)</i>
	Not selected	0.	0
	Selected	1.	1
	DI1	Digital input DI1 (<i>10.02 DI delayed status</i> , bit 0).	2
	DI2	Digital input DI2 (<i>10.02 DI delayed status</i> , bit 1).	3
	DI3	Digital input DI3 (<i>10.02 DI delayed status</i> , bit 2).	4
	DI4	Digital input DI4 (<i>10.02 DI delayed status</i> , bit 3).	5
	DI5	Digital input DI5 (<i>10.02 DI delayed status</i> , bit 4).	6
	DI6	Digital input DI6 (<i>10.02 DI delayed status</i> , bit 5).	7
	DIO1	Digital input/output DIO1 (<i>11.02 DIO delayed status</i> , bit 0).	10
	DIO2	Digital input/output DIO2 (<i>11.02 DIO delayed status</i> , bit 1).	11
	<i>Other [bit]</i>	Source selection (see <i>Terms and abbreviations</i> on page 90).	-
35.104	<i>DOL starter feedback delay</i>	Defines a feedback delay for the motor fan. The delay timer starts when bit 1 of 35.105 switches on. If no feedback is received from the fan until the delay elapses, the action selected by 35.106 is taken. Note: This delay is only applied at start. If the feedback signal is lost during run, the action selected by 35.106 is taken immediately.	0 s; 5 s <i>(95.20 b6)</i>
	0...42949673 s	Motor fan start delay.	1 = 1 s

No.	Name/Value	Description	Def/FbEq16																		
35.105	<i>DOL starter status word</i>	<p>Status of the motor fan control logic.</p> <p>Bit 1 is the control output for the fan, to be selected as the source of, for example, a digital or relay output.</p> <p>The other bits indicate the statuses of the selected control and feedback sources, and the fault status.</p> <p>This parameter is read-only.</p>	-																		
<table border="1"> <thead> <tr> <th>Bit</th> <th>Name</th> <th>Description</th> </tr> </thead> <tbody> <tr> <td>0</td> <td>Start command</td> <td>Status of fan control source selected by 35.100. 0 = Stop requested 1 = Start requested</td> </tr> <tr> <td>1</td> <td>Delayed start command</td> <td>Fan control bit (delays observed). Select this bit as the source of the output controlling the fan. 0 = Stopped 1 = Started</td> </tr> <tr> <td>2</td> <td>DOL feedback</td> <td>Status of fan feedback (source selected by 35.103). 0 = Stopped 1 = Running</td> </tr> <tr> <td>3</td> <td>DOL fault (-1)</td> <td>Fault status. 0 = Fault (fan feedback missing). The action taken is selected by 35.106. 1 = No fault</td> </tr> <tr> <td>4...15</td> <td>Reserved</td> <td></td> </tr> </tbody> </table>				Bit	Name	Description	0	Start command	Status of fan control source selected by 35.100 . 0 = Stop requested 1 = Start requested	1	Delayed start command	Fan control bit (delays observed). Select this bit as the source of the output controlling the fan. 0 = Stopped 1 = Started	2	DOL feedback	Status of fan feedback (source selected by 35.103). 0 = Stopped 1 = Running	3	DOL fault (-1)	Fault status. 0 = Fault (fan feedback missing). The action taken is selected by 35.106 . 1 = No fault	4...15	Reserved	
Bit	Name	Description																			
0	Start command	Status of fan control source selected by 35.100 . 0 = Stop requested 1 = Start requested																			
1	Delayed start command	Fan control bit (delays observed). Select this bit as the source of the output controlling the fan. 0 = Stopped 1 = Started																			
2	DOL feedback	Status of fan feedback (source selected by 35.103). 0 = Stopped 1 = Running																			
3	DOL fault (-1)	Fault status. 0 = Fault (fan feedback missing). The action taken is selected by 35.106 . 1 = No fault																			
4...15	Reserved																				
	0000b...1111b	Status of motor fan control logic.	1 = 1																		
35.106	<i>DOL starter event type</i>	Selects the action taken when missing fan feedback is detected by the motor fan control logic.	<i>Fault</i>																		
	No action	No action taken.	0																		
	Warning	The drive generates a warning (A781 Motor fan).	1																		
	Fault	Drive trips on 71B1 Motor fan .	2																		

No.	Name/Value	Description	Def/FbEq16
36 Load analyzer		Peak value and amplitude logger settings. See also section Load analyzer (page 80).	
36.01	PVL signal source	Selects the signal to be monitored by the peak value logger. The signal is filtered using the filtering time specified by parameter 36.02 PVL filter time . The peak value is stored, along with other pre-selected signals at the time, into parameters 36.10...36.15 . The peak value logger can be reset using parameter 36.09 Reset loggers . The date and time of the last reset are stored into parameters 36.16 and 36.17 respectively.	Power inu out
	Zero	None (peak value logger disabled).	0
	Motor speed used	01.01 Motor speed used (page 94).	1
	Output frequency	01.06 Output frequency (page 94).	3
	Motor current	01.07 Motor current (page 94).	4
	Motor torque	01.10 Motor torque (page 95).	6
	DC voltage	01.11 DC voltage (page 95).	7
	Power inu out	01.14 Output power (page 95).	8
	Speed ref ramp in	23.01 Speed ref ramp input (page 209).	10
	Speed ref ramped	23.02 Speed ref ramp output (page 209).	11
	Speed ref used	24.01 Used speed reference (page 217).	12
	Torq ref used	26.02 Torque reference used (page 234).	13
	Freq ref used	28.02 Frequency ref ramp output (page 243).	14
	Other	Source selection (see Terms and abbreviations on page 90).	-
36.02	PVL filter time	Defines a filtering time for the peak value logger. See parameter 36.01 PVL signal source .	2.00 s
	0.00 ... 120.00 s	Peak value logger filtering time.	100 = 1 s

No.	Name/Value	Description	Def/FbEq16
36.06	<i>AL2 signal source</i>	<p>Selects the signal to be monitored by amplitude logger 2. The signal is sampled at 200 ms intervals. The results are displayed by parameters 36.40...36.49. Each parameter represents an amplitude range, and shows what portion of the samples fall within that range.</p> <p>The signal value corresponding to 100% is defined by parameter 36.07 AL2 signal scaling.</p> <p>Amplitude logger 2 can be reset using parameter 36.09 Reset loggers. The date and time of the last reset are stored into parameters 36.50 and 36.51 respectively.</p> <p>For the selections, see parameter 36.01 PVL signal source.</p>	<i>Motor torque</i>
36.07	<i>AL2 signal scaling</i>	Defines the signal value that corresponds to 100% amplitude.	100.00
	0.00 ... 32767.00	Signal value corresponding to 100%.	1 = 1
36.09	<i>Reset loggers</i>	Resets the peak value logger and/or amplitude logger 2. (Amplitude logger 1 cannot be reset.)	<i>Done</i>
	Done	Reset completed or not requested (normal operation).	0
	All	Reset both the peak value logger and amplitude logger 2.	1
	PVL	Reset the peak value logger.	2
	AL2	Reset amplitude logger 2.	3
36.10	<i>PVL peak value</i>	Displays the peak value recorded by the peak value logger.	0.00
	-32768.00 ... 32767.00	Peak value.	1 = 1
36.11	<i>PVL peak date</i>	Displays the date on which the peak value was recorded.	-
	-	Peak occurrence date.	-
36.12	<i>PVL peak time</i>	Displays the time at which the peak value was recorded.	-
	-	Peak occurrence time.	-
36.13	<i>PVL current at peak</i>	Displays the motor current at the moment the peak value was recorded.	0.00 A
	-32768.00 ... 32767.00 A	Motor current at peak.	1 = 1 A

No.	Name/Value	Description	Def/FbEq16
36.14	<i>PVL DC voltage at peak</i>	Displays the voltage in the intermediate DC circuit of the drive at the moment the peak value was recorded.	0.00 V
	0.00 ... 2000.00 V	DC voltage at peak.	10 = 1 V
36.15	<i>PVL speed at peak</i>	Displays the motor speed at the moment the peak value was recorded.	0.00 rpm
	-32768.00 ... 32767.00 rpm	Motor speed at peak.	See par. 46.01
36.16	<i>PVL reset date</i>	Displays the date on which the peak value logger was last reset.	-
	-	Last reset date of the peak value logger.	-
36.17	<i>PVL reset time</i>	Displays the time at which the peak value logger was last reset.	-
	-	Last reset time of the peak value logger.	-
36.20	<i>AL1 0 to 10%</i>	Displays the percentage of samples recorded by amplitude logger 1 that fall between 0 and 10%.	0.00%
	0.00 ... 100.00%	Amplitude logger 1 samples between 0 and 10%.	1 = 1%
36.21	<i>AL1 10 to 20%</i>	Displays the percentage of samples recorded by amplitude logger 1 that fall between 10 and 20%.	0.00%
	0.00 ... 100.00%	Amplitude logger 1 samples between 10 and 20%.	1 = 1%
36.22	<i>AL1 20 to 30%</i>	Displays the percentage of samples recorded by amplitude logger 1 that fall between 20 and 30%.	0.00%
	0.00 ... 100.00%	Amplitude logger 1 samples between 20 and 30%.	1 = 1%
36.23	<i>AL1 30 to 40%</i>	Displays the percentage of samples recorded by amplitude logger 1 that fall between 30 and 40%.	0.00%
	0.00 ... 100.00%	Amplitude logger 1 samples between 30 and 40%.	1 = 1%
36.24	<i>AL1 40 to 50%</i>	Displays the percentage of samples recorded by amplitude logger 1 that fall between 40 and 50%.	0.00%
	0.00 ... 100.00%	Amplitude logger 1 samples between 40 and 50%.	1 = 1%
36.25	<i>AL1 50 to 60%</i>	Displays the percentage of samples recorded by amplitude logger 1 that fall between 50 and 60%.	0.00%
	0.00 ... 100.00%	Amplitude logger 1 samples between 50 and 60%.	1 = 1%
36.26	<i>AL1 60 to 70%</i>	Displays the percentage of samples recorded by amplitude logger 1 that fall between 60 and 70%.	0.00%
	0.00 ... 100.00%	Amplitude logger 1 samples between 60 and 70%.	1 = 1%
36.27	<i>AL1 70 to 80%</i>	Displays the percentage of samples recorded by amplitude logger 1 that fall between 70 and 80%.	0.00%
	0.00 ... 100.00%	Amplitude logger 1 samples between 70 and 80%.	1 = 1%

No.	Name/Value	Description	Def/FbEq16
36.28	<i>AL1 80 to 90%</i>	Displays the percentage of samples recorded by amplitude logger 1 that fall between 80 and 90%.	0.00%
	0.00 ... 100.00%	Amplitude logger 1 samples between 80 and 90%.	1 = 1%
36.29	<i>AL1 over 90%</i>	Displays the percentage of samples recorded by amplitude logger 1 that exceed 90%.	0.00%
	0.00 ... 100.00%	Amplitude logger 1 samples over 90%.	1 = 1%
36.40	<i>AL2 0 to 10%</i>	Displays the percentage of samples recorded by amplitude logger 2 that fall between 0 and 10%.	0.00%
	0.00 ... 100.00%	Amplitude logger 2 samples between 0 and 10%.	1 = 1%
36.41	<i>AL2 10 to 20%</i>	Displays the percentage of samples recorded by amplitude logger 2 that fall between 10 and 20%.	0.00%
	0.00 ... 100.00%	Amplitude logger 2 samples between 10 and 20%.	1 = 1%
36.42	<i>AL2 20 to 30%</i>	Displays the percentage of samples recorded by amplitude logger 2 that fall between 20 and 30%.	0.00%
	0.00 ... 100.00%	Amplitude logger 2 samples between 20 and 30%.	1 = 1%
36.43	<i>AL2 30 to 40%</i>	Displays the percentage of samples recorded by amplitude logger 2 that fall between 30 and 40%.	0.00%
	0.00 ... 100.00%	Amplitude logger 2 samples between 30 and 40%.	1 = 1%
36.44	<i>AL2 40 to 50%</i>	Displays the percentage of samples recorded by amplitude logger 2 that fall between 40 and 50%.	0.00%
	0.00 ... 100.00%	Amplitude logger 2 samples between 40 and 50%.	1 = 1%
36.45	<i>AL2 50 to 60%</i>	Displays the percentage of samples recorded by amplitude logger 2 that fall between 50 and 60%.	0.00%
	0.00 ... 100.00%	Amplitude logger 2 samples between 50 and 60%.	1 = 1%
36.46	<i>AL2 60 to 70%</i>	Displays the percentage of samples recorded by amplitude logger 2 that fall between 60 and 70%.	0.00%
	0.00 ... 100.00%	Amplitude logger 2 samples between 60 and 70%.	1 = 1%
36.47	<i>AL2 70 to 80%</i>	Displays the percentage of samples recorded by amplitude logger 2 that fall between 70 and 80%.	0.00%
	0.00 ... 100.00%	Amplitude logger 2 samples between 70 and 80%.	1 = 1%
36.48	<i>AL2 80 to 90%</i>	Displays the percentage of samples recorded by amplitude logger 2 that fall between 80 and 90%.	0.00%
	0.00 ... 100.00%	Amplitude logger 2 samples between 80 and 90%.	1 = 1%
36.49	<i>AL2 over 90%</i>	Displays the percentage of samples recorded by amplitude logger 2 that exceed 90%.	0.00%
	0.00 ... 100.00%	Amplitude logger 2 samples over 90%.	1 = 1%
36.50	<i>AL2 reset date</i>	Displays the date on which amplitude logger 2 was last reset.	-
	-	Last reset date of amplitude logger 2.	-

No.	Name/Value	Description	Def/FbEq16
36.51	<i>AL2 reset time</i>	Displays the time at which amplitude logger 2 was last reset.	-
-	-	Last reset time of amplitude logger 2.	-
43 Brake chopper		Settings for the internal brake chopper.	
43.01	<i>Braking resistor temperature</i>	Displays the estimated temperature of the brake resistor, or how close the brake resistor is to being too hot. The value is given in percent where 100% is the temperature the resistor would reach if the maximum continuous braking power (<i>43.09 Brake resistor Pmax cont</i>) is applied to the resistor for 100% rated time. The thermal time constant (<i>43.08 Brake resistor thermal tc</i>) defines the rated time to achieve 63% temperature. 100% would be reached when 100% time has elapsed. This parameter is read-only.	-
	0.0 ... 120.0%	Estimated brake resistor temperature.	1 = 1%
43.06	<i>Brake chopper function</i>	Enables brake chopper control. Note: Before enabling brake chopper control, ensure that <ul style="list-style-type: none"> • a brake resistor is connected, and • the supply voltage range (parameter <i>95.01 Supply voltage</i>) has been selected correctly. 	<i>Disabled</i>
	Disabled	Brake chopper control disabled.	0
	Enabled with thermal model	Brake chopper control enabled with resistor overload protection. Note: Before using this setting, ensure that overvoltage control is switched off (parameter <i>30.30 Overvoltage control</i>).	1
	Enabled without thermal model	Brake chopper control enabled without resistor overload protection. This setting can be used, for example, if the resistor is equipped with a thermal circuit breaker that is wired to stop the drive if the resistor overheats. Before using this setting, ensure that overvoltage control is switched off (parameter <i>30.30 Overvoltage control</i>)	2

No.	Name/Value	Description	Def/FbEq16
	Overvoltage peak protection	<p>Brake chopper control enabled in an overvoltage condition.</p> <p>This setting is intended for situations where</p> <ul style="list-style-type: none"> • the braking chopper is not needed for runtime operation, ie. to dissipate the inertial energy of the motor, • the motor is able to store a considerable amount of magnetic energy in its windings, and • the motor might, deliberately or inadvertently, be stopped by coasting. <p>In such a situation, the motor would potentially discharge enough magnetic energy towards the drive to cause damage. To protect the drive, the brake chopper can be used with a small resistor dimensioned merely to handle the magnetic energy (not the inertial energy) of the motor.</p> <p>With this setting, the brake chopper is activated only whenever the DC voltage exceeds the overvoltage limit. During normal use, the brake chopper is not operating.</p>	3
43.07	<i>Brake chopper run enable</i>	<p>Selects the source for quick brake chopper on/off control.</p> <p>0 = Brake chopper IGBT pulses are cut off 1 = Normal brake chopper IGBT modulation.</p> <p>This parameter can be used to program the chopper control to function only when the supply is missing from a drive with a regenerative supply unit.</p>	On
	Off	0.	0
	On	1.	1
	<i>Other [bit]</i>	Source selection (see <i>Terms and abbreviations</i> on page 90).	-
43.08	<i>Brake resistor thermal tc</i>	Defines the thermal time constant of the brake resistor for overload protection.	0 s
	0 ... 10000 s	Brake resistor thermal time constant.	1 = 1 s
43.09	<i>Brake resistor Pmax cont</i>	Defines the maximum continuous braking power of the resistor (in kW) which will raise the resistor temperature to the maximum allowed value. The value is used in the overload protection.	0.00 kW
	0.00 ... 10000.00 kW	Maximum continuous braking power.	1 = 1 kW

No.	Name/Value	Description	Def/FbEq16																																	
43.10	<i>Brake resistance</i>	Defines the resistance value of the brake resistor. The value is used for brake chopper protection.	0.0 ohm																																	
	0.0 ... 1000.0 ohm	Brake resistor resistance value.	1 = 1 ohm																																	
43.11	<i>Brake resistor fault limit</i>	Selects the fault limit for the brake resistor temperature protection function. When the limit is exceeded, the drive trips on fault <i>7183 BR excess temperature</i> . The value is given in percent of the temperature the resistor reaches when loaded with the power defined by parameter <i>43.09 Brake resistor Pmax cont.</i>	105%																																	
	0 ... 150%	Brake resistor temperature fault limit.	1 = 1%																																	
43.12	<i>Brake resistor warning limit</i>	Selects the warning limit for the brake resistor temperature protection function. When the limit is exceeded, the drive generates a <i>A793 BR excess temperature</i> warning. The value is given in percent of the temperature the resistor reaches when loaded with the power defined by parameter <i>43.09 Brake resistor Pmax cont.</i>	95%																																	
	0 ... 150%	Brake resistor temperature warning limit.	1 = 1%																																	
44 Mechanical brake control		Configuration of mechanical brake control. See also section <i>DC voltage control</i> (page 68).																																		
44.01	<i>Brake control status</i>	Displays the mechanical brake control status word. This parameter is read-only.	-																																	
		<table border="1"> <thead> <tr> <th>Bit</th> <th>Name</th> <th>Information</th> </tr> </thead> <tbody> <tr> <td>0</td> <td>Open command</td> <td>Close/open command to brake actuator (0 = close, 1 = open). Connect this bit to desired output.</td> </tr> <tr> <td>1</td> <td>Opening torque request</td> <td>1 = Opening torque requested from drive logic</td> </tr> <tr> <td>2</td> <td>Hold stopped request</td> <td>1 = Hold requested from drive logic</td> </tr> <tr> <td>3</td> <td>Ramp to stopped</td> <td>1 = Ramping down to zero speed requested from drive logic</td> </tr> <tr> <td>4</td> <td>Enabled</td> <td>1 = Brake control is enabled</td> </tr> <tr> <td>5</td> <td>Closed</td> <td>1 = Brake control logic in state</td> </tr> <tr> <td>6</td> <td>Opening</td> <td>1 = Brake control logic in state</td> </tr> <tr> <td>7</td> <td>Open</td> <td>1 = Brake control logic in state</td> </tr> <tr> <td>8</td> <td>Closing</td> <td>1 = Brake control logic in state</td> </tr> <tr> <td>9...15</td> <td>Reserved</td> <td></td> </tr> </tbody> </table>	Bit	Name	Information	0	Open command	Close/open command to brake actuator (0 = close, 1 = open). Connect this bit to desired output.	1	Opening torque request	1 = Opening torque requested from drive logic	2	Hold stopped request	1 = Hold requested from drive logic	3	Ramp to stopped	1 = Ramping down to zero speed requested from drive logic	4	Enabled	1 = Brake control is enabled	5	Closed	1 = Brake control logic in state	6	Opening	1 = Brake control logic in state	7	Open	1 = Brake control logic in state	8	Closing	1 = Brake control logic in state	9...15	Reserved		
Bit	Name	Information																																		
0	Open command	Close/open command to brake actuator (0 = close, 1 = open). Connect this bit to desired output.																																		
1	Opening torque request	1 = Opening torque requested from drive logic																																		
2	Hold stopped request	1 = Hold requested from drive logic																																		
3	Ramp to stopped	1 = Ramping down to zero speed requested from drive logic																																		
4	Enabled	1 = Brake control is enabled																																		
5	Closed	1 = Brake control logic in state																																		
6	Opening	1 = Brake control logic in state																																		
7	Open	1 = Brake control logic in state																																		
8	Closing	1 = Brake control logic in state																																		
9...15	Reserved																																			
	0000h...FFFFh	Mechanical brake control status word.	1 = 1																																	

No.	Name/Value	Description	Def/FbEq16
44.02	<i>Brake torque memory</i>	Displays the torque (in percent) at the instant of the previous brake close command. This value can be used as a reference for the brake open torque. See parameters 44.09 Brake open torque source and 44.10 Brake open torque .	-
	-1600.0 ... 1600.0%	Torque at brake closure.	See par. 46.03
44.03	<i>Brake open torque reference</i>	Displays the currently active brake open torque. See parameters 44.09 Brake open torque source and 44.10 Brake open torque . This parameter is read-only.	-
	-1600.0 ... 1600.0%	Currently active brake open torque.	See par. 46.03
44.06	<i>Brake control enable</i>	Activates/deactivates (or selects a source that activates/deactivates) the mechanical brake control logic. 0 = Brake control inactive 1 = Brake control active	<i>Not selected</i>
	Not selected	0.	0
	Selected	1.	1
	DI1	Digital input DI1 (10.02 DI delayed status , bit 0).	2
	DI2	Digital input DI2 (10.02 DI delayed status , bit 1).	3
	DI3	Digital input DI3 (10.02 DI delayed status , bit 2).	4
	DI4	Digital input DI4 (10.02 DI delayed status , bit 3).	5
	DI5	Digital input DI5 (10.02 DI delayed status , bit 4).	6
	DI6	Digital input DI6 (10.02 DI delayed status , bit 5).	7
	DIO1	Digital input/output DIO1 (11.02 DIO delayed status , bit 0).	10
	DIO2	Digital input/output DIO2 (11.02 DIO delayed status , bit 1).	11
	<i>Other [bit]</i>	Source selection (see Terms and abbreviations on page 90).	-
44.07	<i>Brake acknowledge selection</i>	Activates/deactivates (and selects the source for) brake open/close status (acknowledgement) supervision. When a brake control error (unexpected state of the acknowledgement signal) is detected, the drive reacts as defined by parameter 44.17 Brake fault function . 0 = Brake closed 1 = Brake open	<i>No acknowledge</i>
	Off	0.	0
	On	1.	1

No.	Name/Value	Description	Def/FbEq16
	No acknowledge	Brake open/closed supervision disabled.	2
	DI1	Digital input DI1 (10.02 DI delayed status , bit 0).	3
	DI2	Digital input DI2 (10.02 DI delayed status , bit 1).	4
	DI3	Digital input DI3 (10.02 DI delayed status , bit 2).	5
	DI4	Digital input DI4 (10.02 DI delayed status , bit 3).	6
	DI5	Digital input DI5 (10.02 DI delayed status , bit 4).	7
	DI6	Digital input DI6 (10.02 DI delayed status , bit 5).	8
	DIO1	Digital input/output DIO1 (11.02 DIO delayed status , bit 0).	11
	DIO2	Digital input/output DIO2 (11.02 DIO delayed status , bit 1).	12
	<i>Other [bit]</i>	Source selection (see Terms and abbreviations on page 90).	-
44.08	Brake open delay	Defines the brake open delay, ie. the delay between the internal open brake command and the release of motor speed control. The delay timer starts when the drive has magnetized the motor and increased the motor torque to the level required for brake release (parameter 44.03 Brake open torque reference). Simultaneously with the timer start, the brake control logic energizes the brake control output and the brake starts to open. Set this parameter to the value of mechanical opening delay specified by the brake manufacturer.	0.00 s
	0.00 ... 5.00 s	Brake open delay.	100 = 1 s
44.09	Brake open torque source	Defines a source that is used as a brake opening torque reference if <ul style="list-style-type: none"> its absolute value is greater than the setting of parameter 44.10 Brake open torque, and its sign is the same as the setting of 44.10 Brake open torque. See parameter 44.10 Brake open torque .	Brake open torque
	Zero	Zero.	0
	AI1 scaled	12.12 AI1 scaled value (see page 137).	1
	AI2 scaled	12.22 AI2 scaled value (see page 140).	2
	FBA ref1	03.05 FB A reference 1 (see page 98).	3
	FBA ref2	03.06 FB A reference 2 (see page 98).	4
	Brake torque memory	Parameter 44.02 Brake torque memory .	7
	Brake open torque	Parameter 44.10 Brake open torque .	8

No.	Name/Value	Description	Def/FbEq16
	<i>Other</i>	Source selection (see <i>Terms and abbreviations</i> on page 90).	-
44.10	<i>Brake open torque</i>	Defines the sign (ie. direction of rotation) and minimum absolute value of the brake open torque (motor torque requested at brake release in percent of motor nominal torque). The value of the source selected by parameter <i>44.09 Brake open torque source</i> is used as the brake open torque only if it has the same sign as this parameter and has a greater absolute value. Note: This parameter is not effective in scalar motor control mode.	0.0%
	-1600.0 ... 1600.0%	Minimum torque at brake release.	See par. <i>46.03</i>
44.11	<i>Keep brake closed</i>	Selects a source that prevents the brake from opening. 0 = Normal brake operation 1 = Keep brake closed Note: This parameter cannot be changed while the drive is running.	<i>Not selected</i>
	Not selected	0.	0
	Selected	1.	1
	DI1	Digital input DI1 (<i>10.02 DI delayed status</i> , bit 0).	2
	DI2	Digital input DI2 (<i>10.02 DI delayed status</i> , bit 1).	3
	DI3	Digital input DI3 (<i>10.02 DI delayed status</i> , bit 2).	4
	DI4	Digital input DI4 (<i>10.02 DI delayed status</i> , bit 3).	5
	DI5	Digital input DI5 (<i>10.02 DI delayed status</i> , bit 4).	6
	DI6	Digital input DI6 (<i>10.02 DI delayed status</i> , bit 5).	7
	DIO1	Digital input/output DIO1 (<i>11.02 DIO delayed status</i> , bit 0).	10
	DIO2	Digital input/output DIO2 (<i>11.02 DIO delayed status</i> , bit 1).	11
	<i>Other [bit]</i>	Source selection (see <i>Terms and abbreviations</i> on page 90).	-

No.	Name/Value	Description	Def/FbEq16
44.12	<i>Brake close request</i>	<p>Selects the source of an external brake close request signal. When on, the signal overrides the internal logic and closes the brake.</p> <p>0 = Normal operation/No external close signal connected 1 = Close brake</p> <p>Notes:</p> <ul style="list-style-type: none"> In an open-loop (encoder-less) application, if the brake is kept closed by a brake close request against a modulating drive for longer than 5 seconds, the brake is forced to close and the drive trips on a fault, <i>71A5 Mechanical brake opening not allowed</i>. This parameter cannot be changed while the drive is running. 	<i>Not selected</i>
	Not selected	0.	0
	Selected	1.	1
	DI1	Digital input DI1 (<i>10.02 DI delayed status</i> , bit 0).	2
	DI2	Digital input DI2 (<i>10.02 DI delayed status</i> , bit 1).	3
	DI3	Digital input DI3 (<i>10.02 DI delayed status</i> , bit 2).	4
	DI4	Digital input DI4 (<i>10.02 DI delayed status</i> , bit 3).	5
	DI5	Digital input DI5 (<i>10.02 DI delayed status</i> , bit 4).	6
	DI6	Digital input DI6 (<i>10.02 DI delayed status</i> , bit 5).	7
	DIO1	Digital input/output DIO1 (<i>11.02 DIO delayed status</i> , bit 0).	10
	DIO2	Digital input/output DIO2 (<i>11.02 DIO delayed status</i> , bit 1).	11
	<i>Other [bit]</i>	Source selection (see <i>Terms and abbreviations</i> on page 90).	-
44.13	<i>Brake close delay</i>	<p>Defines a delay between a close command (that is, when the brake control output is de-energized) and when the drive stops modulating. This is to keep the motor live and under control until the brake actually closes.</p> <p>Set this parameter equal to the value specified by the brake manufacturer as the mechanical make-up time of the brake.</p>	0.00 s
	0.00 ... 60.00 s	Brake close delay.	100 = 1 s

No.	Name/Value	Description	Def/FbEq16
44.14	<i>Brake close level</i>	Defines the brake close speed as an absolute value. After motor speed remains below this level for the duration of the brake close level delay (<i>44.15 Brake close level delay</i>), a close command is given. Note: Check the compatibility of this setting with <i>21.03 Stop mode</i> (and the applicable deceleration time).	10.00 rpm
	0.00 ... 1000.00 rpm	Brake close speed.	See par. <i>46.01</i>
44.15	<i>Brake close level delay</i>	Defines a brake close level delay. See parameter <i>44.14 Brake close level</i> .	0.00 s
	0.00 ... 10.00 s	Brake close level delay.	100 = 1 s
44.16	<i>Brake reopen delay</i>	Defines a minimum time between brake closure and a subsequent open command.	0.00 s
	0.00 ... 10.00 s	Brake reopen delay.	100 = 1 s
44.17	<i>Brake fault function</i>	Determines how the drive reacts upon a mechanical brake control error. Note: If parameter <i>44.07 Brake acknowledge selection</i> is set to <i>No acknowledge</i> , acknowledgement status supervision is disabled altogether and will generate no warnings or faults. However, the brake open conditions are always supervised.	<i>Fault</i>
	Fault	The drive trips on a <i>71A2 Mechanical brake closing failed</i> / <i>71A3 Mechanical brake opening failed</i> fault if the status of the acknowledgement does not match the status presumed by the brake control logic. The drive trips on a <i>71A5 Mechanical brake opening not allowed</i> fault if the brake open conditions cannot be fulfilled (for example, the required motor starting torque is not achieved).	0
	Warning	The drive generates a <i>A7A1 Mechanical brake closing failed</i> / <i>A7A2 Mechanical brake opening failed</i> warning if the status of the acknowledgement does not match the status presumed by the brake control logic. The drive generates a <i>A7A5 Mechanical brake opening not allowed</i> warning if the brake open conditions cannot be fulfilled (for example, the required motor starting torque is not achieved).	1

No.	Name/Value	Description	Def/FbEq16
	Open fault	<p>Upon closing the brake, the drive generates a A7A1 Mechanical brake closing failed warning if the status of the acknowledgement does not match the status presumed by the brake control logic.</p> <p>Upon opening the brake, the drive trips on a 71A3 Mechanical brake opening failed fault if the status of the acknowledgement does not match the status presumed by the brake control logic.</p> <p>The drive trips on a 71A5 Mechanical brake opening not allowed fault if the brake open conditions cannot be fulfilled (for example, the required motor starting torque is not achieved).</p>	2
44.18	Brake fault delay	Defines a close fault delay, ie. time between brake closure and brake close fault trip.	0.00 s
	0.00 ... 60.00 s	Brake close fault delay.	100 = 1 s
45 Energy efficiency		Settings for the energy saving calculators. See also section Energy saving calculators (page 80).	
45.01	Saved GW hours	<p>Displays the energy saved in GWh compared to direct-on-line motor connection. This parameter is incremented when 45.02 Saved MW hours rolls over.</p> <p>This parameter is read-only (see parameter 45.21 Energy calculations reset).</p>	-
	0...65535 GWh	Energy savings in GWh.	1 = 1 GWh
45.02	Saved MW hours	<p>Displays the energy saved in MWh compared to direct-on-line motor connection. This parameter is incremented when 45.03 Saved kW hours rolls over.</p> <p>When this parameter rolls over, parameter 45.01 Saved GW hours is incremented.</p> <p>This parameter is read-only (see parameter 45.21 Energy calculations reset).</p>	-
	0...999 MWh	Energy savings in MWh.	1 = 1 MWh

No.	Name/Value	Description	Def/FbEq16
45.03	<i>Saved kW hours</i>	<p>Displays the energy saved in kWh compared to direct-on-line motor connection.</p> <p>If the internal brake chopper of the drive is enabled, all energy fed by the motor to the drive is assumed to be converted into heat, but the calculation still records savings made by controlling the speed. If the chopper is disabled, then regenerated energy from the motor is also recorded here.</p> <p>When this parameter rolls over, parameter 45.02 Saved MW hours is incremented.</p> <p>This parameter is read-only (see parameter 45.21 Energy calculations reset).</p>	-
	0.0 ... 999.9 kWh	Energy savings in kWh.	10 = 1 kWh
45.05	<i>Saved money x1000</i>	<p>Displays the monetary savings in thousands compared to direct-on-line motor connection. This parameter is incremented when 45.06 Saved money rolls over.</p> <p>The currency is defined by parameter 45.17 Tariff currency unit.</p> <p>This parameter is read-only (see parameter 45.21 Energy calculations reset).</p>	-
	0...4294967295 thousands	Monetary savings in thousands of units.	-
45.06	<i>Saved money</i>	<p>Displays the monetary savings compared to direct-on-line motor connection. This value is a calculated by multiplying the saved energy in kWh by the currently active energy tariff (45.14 Tariff selection).</p> <p>When this parameter rolls over, parameter 45.05 Saved money x1000 is incremented.</p> <p>The currency is defined by parameter 45.17 Tariff currency unit.</p> <p>This parameter is read-only (see parameter 45.21 Energy calculations reset).</p>	-
	0.00 ... 999.99 units	Monetary savings.	1 = 1 unit
45.08	<i>CO2 reduction in kilotons</i>	<p>Displays the reduction in CO₂ emissions in metric kilotons compared to direct-on-line motor connection. This value is incremented when parameter 45.09 CO2 reduction in tons rolls over.</p> <p>This parameter is read-only (see parameter 45.21 Energy calculations reset).</p>	-
	0...65535 metric kilotons	Reduction in CO ₂ emissions in metric kilotons.	1 = 1 metric kiloton

No.	Name/Value	Description	Def/FbEq16
45.09	<i>CO2 reduction in tons</i>	<p>Displays the reduction in CO₂ emissions in metric tons compared to direct-on-line motor connection. This value is calculated by multiplying the saved energy in MWh by the value of parameter 45.18 CO2 conversion factor (by default, 0.5 metric tons/MWh).</p> <p>When this parameter rolls over, parameter 45.08 CO2 reduction in kilotons is incremented.</p> <p>This parameter is read-only (see parameter 45.21 Energy calculations reset).</p>	-
	0.0 ... 999.9 metric tons	Reduction in CO ₂ emissions in metric tons.	1 = 1 metric ton
45.11	<i>Energy optimizer</i>	<p>Enables/disables the energy optimization function. The function optimizes the motor flux so that total energy consumption and motor noise level are reduced when the drive operates below the nominal load. The total efficiency (motor and drive) can be improved by 1...20% depending on load torque and speed.</p> <p>Note: With a permanent magnet motor or a synchronous reluctance motor, energy optimization is always enabled regardless of this parameter.</p>	<i>Disable</i>
	Disable	Energy optimization disabled.	0
	Enable	Energy optimization enabled.	1
45.12	<i>Energy tariff 1</i>	<p>Defines energy tariff 1 (price of energy per kWh). Depending on the setting of parameter 45.14 Tariff selection, either this value or 45.13 Energy tariff 2 is used for reference when monetary savings are calculated.</p> <p>The currency is defined by parameter 45.17 Tariff currency unit.</p> <p>Note: Tariffs are read only at the instant of selection, and are not applied retroactively.</p>	1.000 units
	0.000 ... 4294967.295 units	Energy tariff 1.	-
45.13	<i>Energy tariff 2</i>	<p>Defines energy tariff 2 (price of energy per kWh). See parameter 45.12 Energy tariff 1.</p>	2.000 units
	0.000 ... 4294967.295 units	Energy tariff 2.	-

No.	Name/Value	Description	Def/FbEq16
45.14	<i>Tariff selection</i>	Selects (or defines a source that selects) which pre-defined energy tariff is used. 0 = 45.12 Energy tariff 1 1 = 45.13 Energy tariff 2	Energy tariff 1
	Energy tariff 1	0.	0
	Energy tariff 2	1.	1
	DI1	Digital input DI1 (10.02 DI delayed status , bit 0).	2
	DI2	Digital input DI2 (10.02 DI delayed status , bit 1).	3
	DI3	Digital input DI3 (10.02 DI delayed status , bit 2).	4
	DI4	Digital input DI4 (10.02 DI delayed status , bit 3).	5
	DI5	Digital input DI5 (10.02 DI delayed status , bit 4).	6
	DI6	Digital input DI6 (10.02 DI delayed status , bit 5).	7
	DIO1	Digital input/output DIO1 (11.02 DIO delayed status , bit 0).	10
	DIO2	Digital input/output DIO2 (11.02 DIO delayed status , bit 1).	11
	<i>Other [bit]</i>	Source selection (see Terms and abbreviations on page 90).	-
45.17	<i>Tariff currency unit</i>	Specifies the currency used for the savings calculations.	EUR
	Local currency	Local currency. The name of the currency can be edited by choosing Menu - Settings - Edit texts on the control panel.	100
	EUR	Euro.	101
	USD	US dollar.	102
45.18	<i>CO2 conversion factor</i>	Defines a factor for conversion of saved energy into CO ₂ emissions (kg/kWh or tn/MWh).	0.500 tn/MWh
	0.000 ... 65.535 tn/MWh	Factor for conversion of saved energy into CO ₂ emissions.	1 = 1 tn/MWh
45.19	<i>Comparison power</i>	Actual power that the motor absorbs when connected direct-on-line and operating the application. The value is used for reference when energy savings are calculated. Note: The accuracy of the energy savings calculation is directly dependent on the accuracy of this value. If nothing is entered here, then the nominal motor power is used by the calculation, but that may inflate the energy savings reported as many motors do not absorb nameplate power.	0.0 kW
	0.0 ... 100000.0 kW	Motor power.	See par. 46.04

No.	Name/Value	Description	Def/FbEq16
45.21	<i>Energy calculations reset</i>	Resets the savings counter parameters <i>45.01...45.09</i>	<i>Done</i>
	Done	Reset not requested (normal operation), or reset complete.	0
	Reset	Reset the savings counter parameters. The value reverts automatically to <i>Done</i> .	1
46 Monitoring/scaling settings			
46.01	<i>Speed scaling</i>	Defines the maximum speed value used to define the acceleration ramp rate and the initial speed value used to define the deceleration ramp rate (see parameter group <i>23 Speed reference ramp</i>). The speed acceleration and deceleration ramp times are therefore related to this value (not to parameter <i>30.12 Maximum speed</i>). Also defines the 16-bit scaling of speed-related parameters. The value of this parameter corresponds to 20000 in fieldbus, master/follower etc. communication.	1500.00 rpm; 1800.00 rpm (<i>95.20</i> b0)
	0.10 ... 30000.00 rpm	Acceleration/deceleration terminal/initial speed.	1 = 1 rpm
46.02	<i>Frequency scaling</i>	Defines the maximum frequency value used to define the acceleration ramp rate and the initial frequency value used to define deceleration ramp rate (see parameter group <i>28 Frequency reference chain</i>). The frequency acceleration and deceleration ramp times are therefore related to this value (not to parameter <i>30.14 Maximum frequency</i>). Also defines the 16-bit scaling of frequency-related parameters. The value of this parameter corresponds to 20000 in fieldbus, master/follower etc. communication.	50.00 Hz; 60.00 Hz (<i>95.20</i> b0)
	0.10 ... 1000.00 Hz	Acceleration/deceleration terminal/initial frequency.	10 = 1 Hz
46.03	<i>Torque scaling</i>	Defines the 16-bit scaling of torque parameters. The value of this parameter (in percent of nominal motor torque) corresponds to 10000 in fieldbus, master/follower etc. communication. See also parameter <i>46.42 Torque decimals</i> .	100.0%
	0.1 ... 1000.0%	Torque corresponding to 10000 on fieldbus.	10 = 1%

No.	Name/Value	Description	Def/FbEq16
46.04	<i>Power scaling</i>	Defines the output power value that corresponds to 10000 in fieldbus, master/follower etc. communication. The unit is selected by parameter 96.16 Unit selection .	1000.00 kW or hp
	0.10 ... 30000.00 kW or 0.10 ... 40214.48 hp	Power corresponding to 10000 on fieldbus.	1 = 1 unit
46.05	<i>Current scaling</i>	Defines the 16-bit scaling of current parameters. The value of this parameter corresponds to 10000 in fieldbus, master/follower etc. communication.	10000 A
	0...30000 A	Current corresponding to 10000 on fieldbus.	-
46.06	<i>Speed ref zero scaling</i>	Defines a speed corresponding to a zero reference received from fieldbus (either the embedded fieldbus interface, or interface FBA A or FBA B). For example, with a setting of 500, the fieldbus reference range of 0...20000 would correspond to a speed of 500... [46.01] rpm. Note: This parameter is effective only with the ABB Drives communication profile.	0.00 rpm
	0.00 ... 30000.00 rpm	Speed corresponding to minimum fieldbus reference.	1 = 1 rpm
46.07	<i>Frequency ref zero scaling</i>	Defines a frequency corresponding to a zero reference received from fieldbus (either the embedded fieldbus interface, or interface FBA A or FBA B). For example, with a setting of 30, the fieldbus reference range of 0...20000 would correspond to a speed of 30... [46.02] Hz. Note: This parameter is effective only with the ABB Drives communication profile.	0.00 Hz
	0.00 ... 1000.00 Hz	Frequency corresponding to minimum fieldbus reference.	10 = 1 Hz
46.11	<i>Filter time motor speed</i>	Defines a filter time for signals 01.01 Motor speed used , 01.02 Motor speed estimated , 01.04 Encoder 1 speed filtered and 01.05 Encoder 2 speed filtered .	500 ms
	0...20000 ms	Motor speed signal filter time.	1 = 1 ms
46.12	<i>Filter time output frequency</i>	Defines a filter time for signal 01.06 Output frequency .	500 ms
	0...20000 ms	Output frequency signal filter time.	1 = 1 ms
46.13	<i>Filter time motor torque</i>	Defines a filter time for signal 01.10 Motor torque .	100 ms
	0...20000 ms	Motor torque signal filter time.	1 = 1 ms

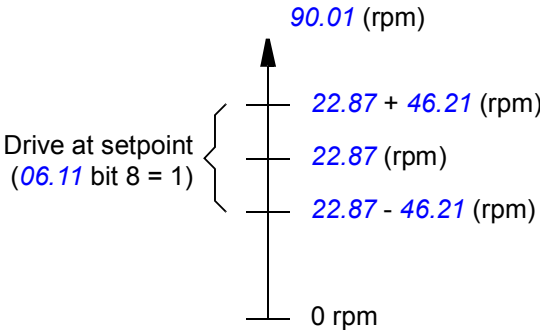
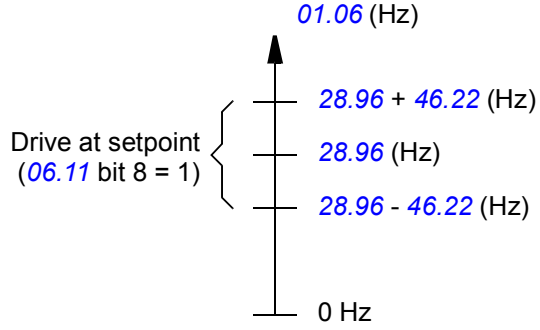
No.	Name/Value	Description	Def/FbEq16
46.14	<i>Filter time power out</i>	Defines a filter time for signal <i>01.14 Output power</i> .	100 ms
	0...20000 ms	Output power signal filter time.	1 = 1 ms
46.21	<i>At speed hysteresis</i>	<p>Defines the “at setpoint” limits for speed control of the drive.</p> <p>When the absolute difference between reference (<i>22.87 Speed reference act 7</i>) and actual speed (<i>90.01 Motor speed for control</i>) is smaller than <i>46.21 At speed hysteresis</i>, the drive is considered to be “at setpoint”. This is indicated by bit 8 of <i>06.11 Main status word</i>.</p> 	100.00 rpm
	0.00 ... 30000.00 rpm	Limit for “at setpoint” indication in speed control.	See par. <i>46.01</i>
46.22	<i>At frequency hysteresis</i>	<p>Defines the “at setpoint” limits for frequency control of the drive. When the absolute difference between reference (<i>28.96 Frequency ref ramp input</i>) and actual frequency (<i>01.06 Output frequency</i>) is smaller than <i>46.22 At frequency hysteresis</i>, the drive is considered to be “at setpoint”. This is indicated by bit 8 of <i>06.11 Main status word</i>.</p> 	10.00 Hz
	0.00 ... 1000.00 Hz	Limit for “at setpoint” indication in frequency control.	See par. <i>46.02</i>



No.	Name/Value	Description	Def/FbEq16
46.23	<i>At torque hysteresis</i>	Defines the “at setpoint” limits for torque control of the drive. When the absolute difference between reference (26.73 Torque reference act 4) and actual torque (01.10 Motor torque) is smaller than 46.23 At torque hysteresis , the drive is considered to be “at setpoint”. This is indicated by bit 8 of 06.11 Main status word .	10.0%
0.0 ... 300.0%		Limit for “at setpoint” indication in torque control.	See par. 46.03
46.31	<i>Above speed limit</i>	Defines the trigger level for “above limit” indication in speed control. When actual speed exceeds the limit, bit 10 of 06.17 Drive status word 2 is set.	1500.00 rpm
0.00 ... 30000.00 rpm		“Above limit” indication trigger level for speed control.	See par. 46.01
46.32	<i>Above frequency limit</i>	Defines the trigger level for “above limit” indication in frequency control. When actual frequency exceeds the limit, bit 10 of 06.17 Drive status word 2 is set.	50.00 Hz
0.00 ... 1000.00 Hz		“Above limit” indication trigger level for frequency control.	See par. 46.02
46.33	<i>Above torque limit</i>	Defines the trigger level for “above limit” indication in torque control. When actual torque exceeds the limit, bit 10 of 06.17 Drive status word 2 is set.	300.0%
0.0 ... 1600.0%		“Above limit” indication trigger level for torque control.	See par. 46.03
46.42	<i>Torque decimals</i>	Defines the number of decimal places of torque-related parameters.	1
0...2		Number of decimal places of torque parameters.	1 = 1

No.	Name/Value	Description	<i>Def/FbEq16</i>
47 Data storage Data storage parameters that can be written to and read from using other parameters' source and target settings. Note that there are different storage parameters for different data types. Integer-type storage parameters cannot be used as the source of other parameters. See also section <i>Data storage parameters</i> (page 82).			
47.01	<i>Data storage 1 real32</i>	Data storage parameter 1. Parameters 47.01...47.08 are real 32-bit numbers that can be used as source values of other parameters. Storage parameters 47.01...47.08 can be used as the target of received 16-bit data (parameter group 62 <i>D2D and DDCS receive data</i>) or the source of transmitted 16-bit data (parameter group 61 <i>D2D and DDCS transmit data</i>). The scaling and range are defined by parameters 47.31...47.38.	0.000
	See par. 47.31	32-bit real (floating point) number.	See par. 47.31
47.02	<i>Data storage 2 real32</i>	Data storage parameter 2. See also parameter 47.01 <i>Data storage 1 real32</i> .	0.000
	See par. 47.32	32-bit real (floating point) number.	See par. 47.32
47.03	<i>Data storage 3 real32</i>	Data storage parameter 3. See also parameter 47.01 <i>Data storage 1 real32</i> .	0.000
	See par. 47.33	32-bit real (floating point) number.	See par. 47.33
47.04	<i>Data storage 4 real32</i>	Data storage parameter 4. See also parameter 47.01 <i>Data storage 1 real32</i> .	0.000
	See par. 47.34	32-bit real (floating point) number.	See par. 47.34
47.05	<i>Data storage 5 real32</i>	Data storage parameter 5. See also parameter 47.01 <i>Data storage 1 real32</i> .	0.000
	See par. 47.35	32-bit real (floating point) number.	See par. 47.35
47.06	<i>Data storage 6 real32</i>	Data storage parameter 6. See also parameter 47.01 <i>Data storage 1 real32</i> .	0.000
	See par. 47.36	32-bit real (floating point) number.	See par. 47.36

No.	Name/Value	Description	Def/FbEq16
47.07	Data storage 7 real32	Data storage parameter 7. See also parameter 47.01 Data storage 1 real32 .	0.000
	See par. 47.37	32-bit real (floating point) number.	See par. 47.37
47.08	Data storage 8 real32	Data storage parameter 8. See also parameter 47.01 Data storage 1 real32 .	0.000
	See par. 47.38	32-bit real (floating point) number.	See par. 47.38
47.11	Data storage 1 int32	Data storage parameter 9.	0
	-2147483648 ... 2147483647	32-bit integer.	-
47.12	Data storage 2 int32	Data storage parameter 10.	0
	-2147483648 ... 2147483647	32-bit integer.	-
47.13	Data storage 3 int32	Data storage parameter 11.	0
	-2147483648 ... 2147483647	32-bit integer.	-
47.14	Data storage 4 int32	Data storage parameter 12.	0
	-2147483648 ... 2147483647	32-bit integer.	-
47.15	Data storage 5 int32	Data storage parameter 13.	0
	-2147483648 ... 2147483647	32-bit integer.	-
47.16	Data storage 6 int32	Data storage parameter 14.	0
	-2147483648 ... 2147483647	32-bit integer.	-
47.17	Data storage 7 int32	Data storage parameter 15.	0
	-2147483648 ... 2147483647	32-bit integer.	-
47.18	Data storage 8 int32	Data storage parameter 16.	0
	-2147483648 ... 2147483647	32-bit integer.	-



No.	Name/Value	Description	Def/FbEq16
47.21	Data storage 1 <i>int16</i>	Data storage parameter 17.	0
	-32768 ... 32767	16-bit integer.	1 = 1
47.22	Data storage 2 <i>int16</i>	Data storage parameter 18.	0
	-32768 ... 32767	16-bit integer.	1 = 1
47.23	Data storage 3 <i>int16</i>	Data storage parameter 19.	0
	-32768 ... 32767	16-bit integer.	1 = 1
47.24	Data storage 4 <i>int16</i>	Data storage parameter 20.	0
	-32768 ... 32767	16-bit integer.	1 = 1
47.25	Data storage 5 <i>int16</i>	Data storage parameter 21.	0
	-32768 ... 32767	16-bit integer.	1 = 1
47.26	Data storage 6 <i>int16</i>	Data storage parameter 22.	0
	-32768 ... 32767	16-bit integer.	1 = 1
47.27	Data storage 7 <i>int16</i>	Data storage parameter 23.	0
	-32768 ... 32767	16-bit integer.	1 = 1
47.28	Data storage 8 <i>int16</i>	Data storage parameter 24.	0
	-32768 ... 32767	16-bit integer.	1 = 1
47.31	Data storage 1 <i>real32 type</i>	Defines the scaling of parameter 47.01 Data storage 1 real32 to and from 16-bit integer format. This scaling is used when the data storage parameter is the target of received 16-bit data (defined in parameter group 62 D2D and DDCS receive data), or when the data storage parameter is the source of transmitted 16-bit data (defined in parameter group 61 D2D and DDCS transmit data). The setting also defines the visible range of the storage parameter.	<i>Unscaled</i>
	Unscaled	Data storage only. Range: -2147483.264 ... 2147473.264.	0
	Transparent	Scaling: 1 = 1. Range: -32768 ... 32767.	1
	General	Scaling: 1 = 100. Range: -327.68 ... 327.67.	2
	Torque	The scaling is defined by parameter 46.03 Torque scaling . Range: -1600.0 ... 1600.0.	3
	Speed	The scaling is defined by parameter 46.01 Speed scaling . Range: -30000.00 ... 30000.00.	4

No.	Name/Value	Description	Def/FbEq16
	Frequency	The scaling is defined by parameter 46.02 Frequency scaling . Range: -500.00 ... 500.00.	5
47.32	Data storage 2 real32 type	Defines the 16-bit scaling of parameter 47.02 Data storage 2 real32 . See parameter 47.31 Data storage 1 real32 type .	Unscaled
47.33	Data storage 3 real32 type	Defines the 16-bit scaling of parameter 47.03 Data storage 3 real32 . See parameter 47.31 Data storage 1 real32 type .	Unscaled
47.34	Data storage 4 real32 type	Defines the 16-bit scaling of parameter 47.04 Data storage 4 real32 . See parameter 47.31 Data storage 1 real32 type .	Unscaled
47.35	Data storage 5 real32 type	Defines the 16-bit scaling of parameter 47.05 Data storage 5 real32 . See parameter 47.31 Data storage 1 real32 type .	Unscaled
47.36	Data storage 6 real32 type	Defines the 16-bit scaling of parameter 47.06 Data storage 6 real32 . See parameter 47.31 Data storage 1 real32 type .	Unscaled
47.37	Data storage 7 real32 type	Defines the 16-bit scaling of parameter 47.07 Data storage 7 real32 . See parameter 47.31 Data storage 1 real32 type .	Unscaled
47.38	Data storage 8 real32 type	Defines the 16-bit scaling of parameter 47.08 Data storage 8 real32 . See parameter 47.31 Data storage 1 real32 type .	Unscaled
49 Panel port communication		Communication settings for the control panel port on the drive.	
49.01	Node ID number	Defines the node ID of the drive. All devices connected to the network must have a unique node ID. Note: For networked drives, it is advisable to reserve ID 1 for spare/replacement drives.	1
	1...32	Node ID.	1 = 1
49.03	Baud rate	Defines the transfer rate of the link.	230.4 kbps
	38.4 kbps	38.4 kbit/s.	1
	57.6 kbps	57.6 kbit/s.	2
	86.4 kbps	86.4 kbit/s.	3
	115.2 kbps	115.2 kbit/s.	4
	230.4 kbps	230.4 kbit/s.	5

No.	Name/Value	Description	Def/FbEq16
49.04	<i>Communication loss time</i>	Sets a timeout for control panel (or PC tool) communication. If a communication break lasts longer than the timeout, the action specified by parameter <i>49.05 Communication loss action</i> is taken.	10.0 s
	0.3 ... 3000.0 s	Panel/PC tool communication timeout.	10 = 1 s
49.05	<i>Communication loss action</i>	Selects how the drive reacts to a control panel (or PC tool) communication break when the panel is the active control or reference source. See also parameter <i>49.08 Secondary comm. loss action</i> .	<i>Fault</i>
	No action	No action taken.	0
	Fault	Drive trips on <i>7081 Control panel loss</i> .	1
	Last speed	Drive generates an <i>A7EE Control panel loss</i> warning and freezes the speed to the level the drive was operating at. The speed is determined on the basis of actual speed using 850 ms low-pass filtering.  WARNING! Make sure that it is safe to continue operation in case of a communication break.	2
	Speed ref safe	Drive generates an <i>A7EE Control panel loss</i> warning and sets the speed to the speed defined by parameter <i>22.41 Speed ref safe</i> (or <i>28.41 Frequency ref safe</i> when frequency reference is being used).  WARNING! Make sure that it is safe to continue operation in case of a communication break.	3
	Warning	Drive generates an <i>A7EE Control panel loss</i> warning. This occurs even though no control is expected from the panel (or PC tool).  WARNING! Make sure that it is safe to continue operation in case of a communication break.	5
49.06	<i>Refresh settings</i>	Applies the settings of parameters <i>49.01...49.05</i> . Note: Refreshing may cause a communication break, so reconnecting the drive may be required.	<i>Done</i>
	Done	Refresh done or not requested.	0
	Refresh	Refresh parameters <i>49.01...49.05</i> . The value reverts automatically to <i>Done</i> .	1

No.	Name/Value	Description	Def/FbEq16															
49.07	<i>Panel comm supervision force</i>	Activates control panel communication monitoring separately for each control location (see section <i>Local control vs. external control</i> on page 26). The parameter is primarily intended for monitoring the communication with the panel when it is connected to the application program and not selected as a control source by drive parameters.	0000b															
<table border="1"> <thead> <tr> <th>Bit</th> <th>Name</th> <th>Value</th> </tr> </thead> <tbody> <tr> <td>0</td> <td>Ext 1</td> <td>1 = Communication monitoring active when Ext 1 is being used.</td> </tr> <tr> <td>1</td> <td>Ext 2</td> <td>1 = Communication monitoring active when Ext 2 is being used.</td> </tr> <tr> <td>2</td> <td>Local</td> <td>1 = Communication monitoring active when local control is being used.</td> </tr> <tr> <td>3...15</td> <td>Reserved</td> <td></td> </tr> </tbody> </table>				Bit	Name	Value	0	Ext 1	1 = Communication monitoring active when Ext 1 is being used.	1	Ext 2	1 = Communication monitoring active when Ext 2 is being used.	2	Local	1 = Communication monitoring active when local control is being used.	3...15	Reserved	
Bit	Name	Value																
0	Ext 1	1 = Communication monitoring active when Ext 1 is being used.																
1	Ext 2	1 = Communication monitoring active when Ext 2 is being used.																
2	Local	1 = Communication monitoring active when local control is being used.																
3...15	Reserved																	
	0000b...0111b	Panel communication monitoring selection.	1 = 1															
49.08	<i>Secondary comm. loss action</i>	Selects how the drive reacts to a control panel (or PC tool) communication break when the panel is parametrized as an alternative control or reference source but is not currently the active source.	<i>No action</i>															
	No action	No action taken.	0															
	Warning	Drive generates an <i>A7EE Control panel loss</i> warning.  WARNING! Make sure that it is safe to continue operation in case of a communication break.	5															
49.14	<i>Panel speed reference unit</i>	Defines the unit for speed reference when given from the control panel.	<i>rpm</i>															
	rpm	rpm.	0															
	%	Percent of absolute value of <i>30.12 Maximum speed</i> or <i>30.11 Minimum speed</i> , whichever is greater.	1															
49.15	<i>Minimum speed ref panel</i>	Defines a minimum limit for control panel speed reference.	-1500.00 rpm															
	-30000.00 ... 30000.00 rpm	Minimum speed reference.	See par. <i>46.01</i>															
49.16	<i>Maximum speed ref panel</i>	Defines a maximum limit for control panel speed reference.	1500.00 rpm															
	-30000.00 ... 30000.00 rpm	Maximum speed reference.	See par. <i>46.01</i>															

No.	Name/Value	Description	Def/FbEq16
49.17	<i>Minimum frequency ref panel</i>	Defines a minimum limit for control panel frequency reference.	-50.00 Hz
	-500.00 ... 500.00 Hz	Minimum frequency reference.	See par. 46.02
49.18	<i>Maximum frequency ref panel</i>	Defines a maximum limit for control panel frequency reference.	50.00 Hz
	-500.00 ... 500.00 Hz	Maximum frequency reference.	See par. 46.02
50 Fieldbus adapter (FBA)		Fieldbus communication configuration. See also chapter <i>Fieldbus control through a fieldbus adapter</i> (page 551).	
50.01	<i>FBA A enable</i>	Enables/disables communication between the drive and fieldbus adapter A, and specifies the slot the adapter is installed into.	<i>Disable</i>
	Disable	Communication between drive and fieldbus adapter A disabled.	0
	Option slot 1	Communication between drive and fieldbus adapter A enabled. The adapter is in slot 1.	1
	Option slot 2	Communication between drive and fieldbus adapter A enabled. The adapter is in slot 2.	2
	Option slot 3	Communication between drive and fieldbus adapter A enabled. The adapter is in slot 3.	3
50.02	<i>FBA A comm loss func</i>	Selects how the drive reacts upon a fieldbus communication break. The time delay is defined by parameter 50.03 FBA A comm loss t out .	<i>No action</i>
	No action	No action taken.	0
	Fault	Communication break detection active. Upon a communication break, the drive trips on a 7510 FBA A communication fault and coasts to a stop.	1
	Last speed	Communication break detection active. Upon a communication break, the drive generates a warning (A7C1 FBA A communication) and freezes the speed to the level the drive was operating at. The speed is determined on the basis of actual speed using 850 ms low-pass filtering.  WARNING! Make sure that it is safe to continue operation in case of a communication break.	2

No.	Name/Value	Description	Def/FbEq16										
	Speed ref safe	Communication break detection active. Upon a communication break, the drive generates a warning (<i>A7C1 FBA A communication</i>) and sets the speed to the value defined by parameter <i>22.41 Speed ref safe</i> (when speed reference is being used) or <i>28.41 Frequency ref safe</i> (when frequency reference is being used).  WARNING! Make sure that it is safe to continue operation in case of a communication break.	3										
	Fault always	Drive trips on <i>7510 FBA A communication</i> . This occurs even though no control is expected from the fieldbus.	4										
	Warning	Drive generates an <i>A7C1 FBA A communication</i> warning. This occurs even though no control is expected from the fieldbus.  WARNING! Make sure that it is safe to continue operation in case of a communication break.	5										
<i>50.03</i>	<i>FBA A comm loss t out</i>	Defines the time delay before the action defined by parameter <i>50.02 FBA A comm loss func</i> is taken. Time count starts when the communication link fails to update the message. As a rule of thumb, this parameter should be set to at least 3 times the transmit interval of the master.	0.3 s										
	0.3 ... 6553.5 s	Time delay.	1 = 1 s										
<i>50.04</i>	<i>FBA A ref1 type</i>	Selects the type and scaling of reference 1 received from fieldbus adapter A.	<i>Speed or frequency</i>										
	Speed or frequency	Type and scaling are chosen automatically according to the currently active operation mode as follows:	0										
<table border="1"> <thead> <tr> <th>Operation mode (see par. <i>19.01</i>)</th> <th>Reference type</th> <th>Scaling</th> </tr> </thead> <tbody> <tr> <td>Speed control</td> <td rowspan="2"><i>Speed</i></td> <td rowspan="2"><i>46.01 Speed scaling</i></td> </tr> <tr> <td>Torque control</td> </tr> <tr> <td>Frequency control</td> <td><i>Frequency</i></td> <td><i>46.02 Frequency scaling</i></td> </tr> </tbody> </table>				Operation mode (see par. <i>19.01</i>)	Reference type	Scaling	Speed control	<i>Speed</i>	<i>46.01 Speed scaling</i>	Torque control	Frequency control	<i>Frequency</i>	<i>46.02 Frequency scaling</i>
Operation mode (see par. <i>19.01</i>)	Reference type	Scaling											
Speed control	<i>Speed</i>	<i>46.01 Speed scaling</i>											
Torque control													
Frequency control	<i>Frequency</i>	<i>46.02 Frequency scaling</i>											
	Transparent	No scaling is applied.	1										
	General	Generic reference with a scaling of 100 = 1 (ie. integer and two decimals).	2										
	Torque	The scaling is defined by parameter <i>46.03 Torque scaling</i> .	3										
	Speed	The scaling is defined by parameter <i>46.01 Speed scaling</i> .	4										



No.	Name/Value	Description	Def/FbEq16										
	Frequency	The scaling is defined by parameter 46.02 Frequency scaling .	5										
50.05	FBA A ref2 type	Selects the type and scaling of reference 2 received from fieldbus adapter A. For the selections, see parameter 50.04 FBA A ref1 type .	Speed or frequency										
50.07	FBA A actual 1 type	Selects the type/source and scaling of actual value 1 transmitted to the fieldbus network through fieldbus adapter A.	Speed or frequency										
	Speed or frequency	Type/source and scaling are chosen automatically according to the currently active operation mode as follows:	0										
<table border="1"> <thead> <tr> <th>Operation mode (see par. 19.01)</th> <th>Actual 1 type (source)</th> <th>Scaling</th> </tr> </thead> <tbody> <tr> <td>Speed control</td> <td rowspan="2">Speed (01.01 Motor speed used)</td> <td rowspan="2">46.01 Speed scaling</td> </tr> <tr> <td>Torque control</td> </tr> <tr> <td>Frequency control</td> <td>Frequency (01.06 Output frequency)</td> <td>46.02 Frequency scaling</td> </tr> </tbody> </table>				Operation mode (see par. 19.01)	Actual 1 type (source)	Scaling	Speed control	Speed (01.01 Motor speed used)	46.01 Speed scaling	Torque control	Frequency control	Frequency (01.06 Output frequency)	46.02 Frequency scaling
Operation mode (see par. 19.01)	Actual 1 type (source)	Scaling											
Speed control	Speed (01.01 Motor speed used)	46.01 Speed scaling											
Torque control													
Frequency control	Frequency (01.06 Output frequency)	46.02 Frequency scaling											
	Transparent	The value selected by parameter 50.10 FBA A act1 transparent source is sent as actual value 1. No scaling is applied (the 16-bit scaling is 1 = 1 unit).	1										
	General	The value selected by parameter 50.10 FBA A act1 transparent source is sent as actual value 1 with a 16-bit scaling of 100 = 1 unit (ie. integer and two decimals).	2										
	Torque	01.10 Motor torque is sent as actual value 1. The scaling is defined by parameter 46.03 Torque scaling .	3										
	Speed	01.01 Motor speed used is sent as actual value 1. The scaling is defined by parameter 46.01 Speed scaling .	4										
	Frequency	01.06 Output frequency is sent as actual value 1. The scaling is defined by parameter 46.02 Frequency scaling .	5										
	Position	Motor position is sent as actual value 1. See parameter 90.06 Motor position scaled .	6										

No.	Name/Value	Description	Def/FbEq16												
50.08	<i>FBA A actual 2 type</i>	Selects the type/source and scaling of actual value 2 transmitted to the fieldbus network through fieldbus adapter A.	<i>Speed or frequency</i>												
	Speed or frequency	Type/source and scaling are chosen automatically according to the currently active operation mode as follows:	0												
		<table border="1"> <thead> <tr> <th>Operation mode (see par. 19.01)</th> <th>Actual 2 type (source)</th> <th>Scaling</th> </tr> </thead> <tbody> <tr> <td>Speed control</td> <td><i>Speed</i> (01.01 Motor speed used)</td> <td>46.01 Speed scaling</td> </tr> <tr> <td>Torque control</td> <td></td> <td></td> </tr> <tr> <td>Frequency control</td> <td><i>Frequency</i> (01.06 Output frequency)</td> <td>46.02 Frequency scaling</td> </tr> </tbody> </table>	Operation mode (see par. 19.01)	Actual 2 type (source)	Scaling	Speed control	<i>Speed</i> (01.01 Motor speed used)	46.01 Speed scaling	Torque control			Frequency control	<i>Frequency</i> (01.06 Output frequency)	46.02 Frequency scaling	
Operation mode (see par. 19.01)	Actual 2 type (source)	Scaling													
Speed control	<i>Speed</i> (01.01 Motor speed used)	46.01 Speed scaling													
Torque control															
Frequency control	<i>Frequency</i> (01.06 Output frequency)	46.02 Frequency scaling													
	Transparent	The value selected by parameter 50.11 <i>FBA A act2 transparent source</i> is sent as actual value 2. No scaling is applied (the 16-bit scaling is 1 = 1 unit).	1												
	General	The value selected by parameter 50.11 <i>FBA A act2 transparent source</i> is sent as actual value 2 with a 16-bit scaling of 100 = 1 unit (ie. integer and two decimals).	2												
	Torque	01.10 <i>Motor torque</i> is sent as actual value 2. The scaling is defined by parameter 46.03 <i>Torque scaling</i> .	3												
	Speed	01.01 <i>Motor speed used</i> is sent as actual value 2. The scaling is defined by parameter 46.01 <i>Speed scaling</i> .	4												
	Frequency	01.06 <i>Output frequency</i> is sent as actual value 2. The scaling is defined by parameter 46.02 <i>Frequency scaling</i> .	5												
	Position	Motor position is sent as actual value 2. See parameter 90.06 <i>Motor position scaled</i> .	6												
50.09	<i>FBA A SW transparent source</i>	Selects the source of the fieldbus status word when the fieldbus adapter is set to a transparent communication profile eg. by its configuration parameters (group 51 <i>FBA A settings</i>).	<i>Not selected</i>												
	Not selected	No source selected.	-												
	<i>Other</i>	Source selection (see <i>Terms and abbreviations</i> on page 90).	-												
50.10	<i>FBA A act1 transparent source</i>	When parameter 50.07 <i>FBA A actual 1 type</i> is set to <i>Transparent</i> or <i>General</i> , this parameter selects the source of actual value 1 transmitted to the fieldbus network through fieldbus adapter A.	<i>Not selected</i>												
	Not selected	No source selected.	-												

No.	Name/Value	Description	Def/FbEq16
	<i>Other</i>	Source selection (see <i>Terms and abbreviations</i> on page 90).	-
50.11	<i>FBA A act2 transparent source</i>	When parameter <i>50.08 FBA A actual 2 type</i> is set to <i>Transparent</i> or <i>General</i> , this parameter selects the source of actual value 2 transmitted to the fieldbus network through fieldbus adapter A.	<i>Not selected</i>
	Not selected	No source selected.	-
	<i>Other</i>	Source selection (see <i>Terms and abbreviations</i> on page 90).	-
50.12	<i>FBA A debug mode</i>	Enables the display of raw (unmodified) data received from and sent to fieldbus adapter A in parameters <i>50.13...50.18</i> . This functionality should only be used for debugging.	<i>Disable</i>
	Disable	Display of raw data from fieldbus adapter A disabled.	0
	Fast	Display of raw data from fieldbus adapter A enabled.	1
50.13	<i>FBA A control word</i>	Displays the raw (unmodified) control word sent by the master (PLC) to fieldbus adapter A if debugging is enabled by parameter <i>50.12 FBA A debug mode</i> . This parameter is read-only.	-
	00000000h ... FFFFFFFFh	Control word sent by master to fieldbus adapter A.	-
50.14	<i>FBA A reference 1</i>	Displays raw (unmodified) reference REF1 sent by the master (PLC) to fieldbus adapter A if debugging is enabled by parameter <i>50.12 FBA A debug mode</i> . This parameter is read-only.	-
	-2147483648 ... 2147483647	Raw REF1 sent by master to fieldbus adapter A.	-
50.15	<i>FBA A reference 2</i>	Displays raw (unmodified) reference REF2 sent by the master (PLC) to fieldbus adapter A if debugging is enabled by parameter <i>50.12 FBA A debug mode</i> . This parameter is read-only.	-
	-2147483648 ... 2147483647	Raw REF2 sent by master to fieldbus adapter A.	-
50.16	<i>FBA A status word</i>	Displays the raw (unmodified) status word sent by fieldbus adapter A to the master (PLC) if debugging is enabled by parameter <i>50.12 FBA A debug mode</i> . This parameter is read-only.	-
	00000000h ... FFFFFFFFh	Status word sent by fieldbus adapter A to master.	-

No.	Name/Value	Description	Def/FbEq16															
50.17	<i>FBA A actual value 1</i>	Displays raw (unmodified) actual value ACT1 sent by fieldbus adapter A to the master (PLC) if debugging is enabled by parameter <i>50.12 FBA A debug mode</i> . This parameter is read-only.	-															
	-2147483648 ... 2147483647	Raw ACT1 sent by fieldbus adapter A to master.	-															
50.18	<i>FBA A actual value 2</i>	Displays raw (unmodified) actual value ACT2 sent by fieldbus adapter A to the master (PLC) if debugging is enabled by parameter <i>50.12 FBA A debug mode</i> . This parameter is read-only.	-															
	-2147483648 ... 2147483647	Raw ACT2 sent by fieldbus adapter A to master.	-															
50.21	<i>FBA A timelevel sel</i>	Selects the communication time levels. In general, lower time levels of read/write services reduce CPU load. The table below shows the time levels of the read/write services for cyclic high and cyclic low data with each parameter setting. <table border="1" data-bbox="572 1055 1235 1263"> <thead> <tr> <th>Selection</th> <th>Cyclic high *</th> <th>Cyclic low **</th> </tr> </thead> <tbody> <tr> <td><i>Monitoring</i></td> <td>10 ms</td> <td>2 ms</td> </tr> <tr> <td><i>Normal</i></td> <td>2 ms</td> <td>10 ms</td> </tr> <tr> <td><i>Fast</i></td> <td>500 µs</td> <td>2 ms</td> </tr> <tr> <td><i>Very fast</i></td> <td>250 µs</td> <td>2 ms</td> </tr> </tbody> </table> * Cyclic high data consists of fieldbus Status word, Act1 and Act2. ** Cyclic low data consists of the parameter data mapped to parameter groups <i>52 FBA A data in</i> and <i>53 FBA A data out</i> , and acyclic data. Control word, Ref1 and Ref2 are handled as interrupts generated on receipt of cyclic high messages.	Selection	Cyclic high *	Cyclic low **	<i>Monitoring</i>	10 ms	2 ms	<i>Normal</i>	2 ms	10 ms	<i>Fast</i>	500 µs	2 ms	<i>Very fast</i>	250 µs	2 ms	<i>Normal</i>
Selection	Cyclic high *	Cyclic low **																
<i>Monitoring</i>	10 ms	2 ms																
<i>Normal</i>	2 ms	10 ms																
<i>Fast</i>	500 µs	2 ms																
<i>Very fast</i>	250 µs	2 ms																
	Normal	Normal speed.	0															
	Fast	Fast speed.	1															
	Very fast	Very fast speed.	2															
	Monitoring	Low speed. Optimized for PC tool communication and monitoring usage.	3															

No.	Name/Value	Description	Def/FbEq16															
50.26	<i>FBA A comm supervision force</i>	Activates fieldbus communication monitoring separately for each control location (see section <i>Local control vs. external control</i> on page 26). The parameter is primarily intended for monitoring the communication with FBA A when it is connected to the application program and not selected as a control source by drive parameters.	0000b															
<table border="1"> <thead> <tr> <th>Bit</th> <th>Name</th> <th>Value</th> </tr> </thead> <tbody> <tr> <td>0</td> <td>Ext 1</td> <td>1 = Communication monitoring active when Ext 1 is being used.</td> </tr> <tr> <td>1</td> <td>Ext 2</td> <td>1 = Communication monitoring active when Ext 2 is being used.</td> </tr> <tr> <td>2</td> <td>Local</td> <td>1 = Communication monitoring active when local control is being used.</td> </tr> <tr> <td>3...15</td> <td>Reserved</td> <td></td> </tr> </tbody> </table>				Bit	Name	Value	0	Ext 1	1 = Communication monitoring active when Ext 1 is being used.	1	Ext 2	1 = Communication monitoring active when Ext 2 is being used.	2	Local	1 = Communication monitoring active when local control is being used.	3...15	Reserved	
Bit	Name	Value																
0	Ext 1	1 = Communication monitoring active when Ext 1 is being used.																
1	Ext 2	1 = Communication monitoring active when Ext 2 is being used.																
2	Local	1 = Communication monitoring active when local control is being used.																
3...15	Reserved																	
	0000b...0111b	FBA A communication monitoring selection.	1 = 1															
50.31	<i>FBA B enable</i>	Enables/disables communication between the drive and fieldbus adapter B, and specifies the slot the adapter is installed into.	<i>Disable</i>															
	Disable	Communication between drive and fieldbus adapter B disabled.	0															
	Option slot 1	Communication between drive and fieldbus adapter B enabled. The adapter is in slot 1.	1															
	Option slot 2	Communication between drive and fieldbus adapter B enabled. The adapter is in slot 2.	2															
	Option slot 3	Communication between drive and fieldbus adapter B enabled. The adapter is in slot 3.	3															
50.32	<i>FBA B comm loss func</i>	Selects how the drive reacts upon a fieldbus communication break. The time delay is defined by parameter <i>50.33 FBA B comm loss timeout</i> .	<i>No action</i>															
	No action	No action taken.	0															
	Fault	Communication break detection active. Upon a communication break, the drive trips on a <i>7520 FBA B communication</i> fault and coasts to a stop.	1															

No.	Name/Value	Description	Def/FbEq16
	Last speed	<p>Communication break detection active. Upon a communication break, the drive generates a warning (<i>A7C2 FBA B communication</i>) and freezes the speed to the level the drive was operating at. The speed is determined on the basis of actual speed using 850 ms low-pass filtering.</p> <p> WARNING! Make sure that it is safe to continue operation in case of a communication break.</p>	2
	Speed ref safe	<p>Communication break detection active. Upon a communication break, the drive generates a warning (<i>A7C2 FBA B communication</i>) and sets the speed to the value defined by parameter <i>22.41 Speed ref safe</i> (or <i>28.41 Frequency ref safe</i> when frequency reference is being used).</p> <p> WARNING! Make sure that it is safe to continue operation in case of a communication break.</p>	3
	Fault always	<p>Drive trips on <i>7520 FBA B communication</i>. This occurs even though no control is expected from the fieldbus.</p>	4
	Warning	<p>Drive generates an <i>A7C2 FBA B communication</i> warning. This occurs even though no control is expected from the fieldbus.</p> <p> WARNING! Make sure that it is safe to continue operation in case of a communication break.</p>	5
50.33	<i>FBA B comm loss timeout</i>	<p>Defines the time delay before the action defined by parameter <i>50.32 FBA B comm loss func</i> is taken. Time count starts when the communication link fails to update the message.</p> <p>As a rule of thumb, this parameter should be set to at least 3 times the transmit interval of the master.</p>	0.3 s
	0.3 ... 6553.5 s	Time delay.	1 = 1 s
50.34	<i>FBA B ref1 type</i>	<p>Selects the type and scaling of reference 1 received from fieldbus adapter B.</p> <p>For the selections, see parameter <i>50.04 FBA A ref1 type</i>.</p>	<i>Speed or frequency</i>
50.35	<i>FBA B ref2 type</i>	<p>Selects the type and scaling of reference 2 received from fieldbus adapter B.</p> <p>For the selections, see parameter <i>50.04 FBA A ref1 type</i>.</p>	<i>Speed or frequency</i>

No.	Name/Value	Description	Def/FbEq16
50.37	<i>FBA B actual 1 type</i>	Selects the type/source and scaling of actual value 1 transmitted to the fieldbus network through fieldbus adapter B. See parameter <i>50.07 FBA A actual 1 type</i> .	<i>Speed or frequency</i>
50.38	<i>FBA B actual 2 type</i>	Selects the type/source and scaling of actual value 2 transmitted to the fieldbus network through fieldbus adapter B. See parameter <i>50.08 FBA A actual 2 type</i> .	<i>Speed or frequency</i>
50.39	<i>FBA B SW transparent source</i>	Selects the source of the fieldbus status word when the fieldbus adapter is set to a transparent communication profile eg. by its configuration parameters (group <i>54 FBA B settings</i>).	<i>Not selected</i>
	Not selected	No source selected.	-
	<i>Other</i>	Source selection (see <i>Terms and abbreviations</i> on page 90).	-
50.40	<i>FBA B act1 transparent source</i>	When parameter <i>50.37 FBA B actual 1 type</i> is set to <i>Transparent</i> or <i>General</i> , this parameter selects the source of actual value 1 transmitted to the fieldbus network through fieldbus adapter B.	<i>Not selected</i>
	Not selected	No source selected.	-
	<i>Other</i>	Source selection (see <i>Terms and abbreviations</i> on page 90).	-
50.41	<i>FBA B act2 transparent source</i>	When parameter <i>50.38 FBA B actual 2 type</i> is set to <i>Transparent</i> or <i>General</i> , this parameter selects the source of actual value 2 transmitted to the fieldbus network through fieldbus adapter B.	<i>Not selected</i>
	Not selected	No source selected.	-
	<i>Other</i>	Source selection (see <i>Terms and abbreviations</i> on page 90).	-
50.42	<i>FBA B debug mode</i>	Enables the display of raw (unmodified) data received from and sent to fieldbus adapter B in parameters <i>50.43...50.48</i> . This functionality should only be used for debugging.	<i>Disable</i>
	Disable	Display of raw data from fieldbus adapter B disabled.	0
	Fast	Display of raw data from fieldbus adapter B enabled.	1
50.43	<i>FBA B control word</i>	Displays the raw (unmodified) control word sent by the master (PLC) to fieldbus adapter B if debugging is enabled by parameter <i>50.42 FBA B debug mode</i> . This parameter is read-only.	-
	00000000h ... FFFFFFFFh	Control word sent by master to fieldbus adapter B.	-

No.	Name/Value	Description	Def/FbEq16
50.44	<i>FBA B reference 1</i>	Displays raw (unmodified) reference REF1 sent by the master (PLC) to fieldbus adapter B if debugging is enabled by parameter <i>50.42 FBA B debug mode</i> . This parameter is read-only.	-
	-2147483648 ... 2147483647	Raw REF1 sent by master to fieldbus adapter B.	-
50.45	<i>FBA B reference 2</i>	Displays raw (unmodified) reference REF2 sent by the master (PLC) to fieldbus adapter B if debugging is enabled by parameter <i>50.42 FBA B debug mode</i> . This parameter is read-only.	-
	-2147483648 ... 2147483647	Raw REF2 sent by master to fieldbus adapter B.	-
50.46	<i>FBA B status word</i>	Displays the raw (unmodified) status word sent by fieldbus adapter B to the master (PLC) if debugging is enabled by parameter <i>50.42 FBA B debug mode</i> . This parameter is read-only.	-
	00000000h ... FFFFFFFFh	Status word sent by fieldbus adapter B to master.	-
50.47	<i>FBA B actual value 1</i>	Displays raw (unmodified) actual value ACT1 sent by fieldbus adapter B to the master (PLC) if debugging is enabled by parameter <i>50.42 FBA B debug mode</i> . This parameter is read-only.	-
	-2147483648 ... 2147483647	Raw ACT1 sent by fieldbus adapter B to master.	-
50.48	<i>FBA B actual value 2</i>	Displays raw (unmodified) actual value ACT2 sent by fieldbus adapter B to the master (PLC) if debugging is enabled by parameter <i>50.42 FBA B debug mode</i> . This parameter is read-only.	-
	-2147483648 ... 2147483647	Raw ACT2 sent by fieldbus adapter B to master.	-

No.	Name/Value	Description	Def/FbEq16															
50.51	<i>FBA B timelevel sel</i>	<p>Selects the communication time levels.</p> <p>In general, lower time levels of read/write services reduce CPU load. The table below shows the time levels of the read/write services for cyclic high and cyclic low data with each parameter setting.</p> <table border="1"> <thead> <tr> <th>Selection</th> <th>Cyclic high *</th> <th>Cyclic low **</th> </tr> </thead> <tbody> <tr> <td><i>Monitoring</i></td> <td>10 ms</td> <td>2 ms</td> </tr> <tr> <td><i>Normal</i></td> <td>2 ms</td> <td>10 ms</td> </tr> <tr> <td><i>Fast</i></td> <td>500 µs</td> <td>2 ms</td> </tr> <tr> <td><i>Very fast</i></td> <td>250 µs</td> <td>2 ms</td> </tr> </tbody> </table> <p>* Cyclic high data consists of fieldbus Status word, Act1 and Act2.</p> <p>** Cyclic low data consists of the parameter data mapped to parameter groups <i>55 FBA B data in</i> and <i>56 FBA B data out</i>, and acyclic data.</p> <p>Control word, Ref1 and Ref2 are handled as interrupts generated on receipt of cyclic high messages.</p>	Selection	Cyclic high *	Cyclic low **	<i>Monitoring</i>	10 ms	2 ms	<i>Normal</i>	2 ms	10 ms	<i>Fast</i>	500 µs	2 ms	<i>Very fast</i>	250 µs	2 ms	<i>Normal</i>
Selection	Cyclic high *	Cyclic low **																
<i>Monitoring</i>	10 ms	2 ms																
<i>Normal</i>	2 ms	10 ms																
<i>Fast</i>	500 µs	2 ms																
<i>Very fast</i>	250 µs	2 ms																
	Normal	Normal speed.	0															
	Fast	Fast speed.	1															
	Very fast	Very fast speed.	2															
	Monitoring	Low speed. Optimized for PC tool communication and monitoring usage.	3															
50.56	<i>FBA B comm supervision force</i>	<p>Activates fieldbus communication monitoring separately for each control location (see section <i>Local control vs. external control</i> on page 26).</p> <p>The parameter is primarily intended for monitoring the communication with FBA B when it is connected to the application program and not selected as a control source by drive parameters.</p>	0000b															
		<table border="1"> <thead> <tr> <th>Bit</th> <th>Name</th> <th>Value</th> </tr> </thead> <tbody> <tr> <td>0</td> <td>Ext 1</td> <td>1 = Communication monitoring active when Ext 1 is being used.</td> </tr> <tr> <td>1</td> <td>Ext 2</td> <td>1 = Communication monitoring active when Ext 2 is being used.</td> </tr> <tr> <td>2</td> <td>Local</td> <td>1 = Communication monitoring active when local control is being used.</td> </tr> <tr> <td>3...15</td> <td>Reserved</td> <td></td> </tr> </tbody> </table>	Bit	Name	Value	0	Ext 1	1 = Communication monitoring active when Ext 1 is being used.	1	Ext 2	1 = Communication monitoring active when Ext 2 is being used.	2	Local	1 = Communication monitoring active when local control is being used.	3...15	Reserved		
Bit	Name	Value																
0	Ext 1	1 = Communication monitoring active when Ext 1 is being used.																
1	Ext 2	1 = Communication monitoring active when Ext 2 is being used.																
2	Local	1 = Communication monitoring active when local control is being used.																
3...15	Reserved																	
	0000b...0111b	FBA B communication monitoring selection.	1 = 1															

No.	Name/Value	Description	Def/FbEq16
51 FBA A settings		Fieldbus adapter A configuration.	
51.01	<i>FBA A type</i>	Displays the type of the connected fieldbus adapter module. 0 = Module is not found or is not properly connected, or is disabled by parameter 50.01 FBA A enable ; 1 = FPBA; 32 = FCAN; 37 = FDNA; 101 = FCNA, 128 = FENA-11/21; 135 = FECA; 136 = FEPL; 485 = FSCA. This parameter is read-only.	-
51.02	<i>FBA A Par2</i>	Parameters 51.02...51.26 are adapter module-specific. For more information, see the documentation of the fieldbus adapter module. Note that not all of these parameters are necessarily in use.	-
	0...65535	Fieldbus adapter configuration parameter.	1 = 1

51.26	<i>FBA A Par26</i>	See parameter 51.02 FBA A Par2 .	-
	0...65535	Fieldbus adapter configuration parameter.	1 = 1
51.27	<i>FBA A par refresh</i>	Validates any changed fieldbus adapter module configuration settings. After refreshing, the value reverts automatically to <i>Done</i> . Note: This parameter cannot be changed while the drive is running.	<i>Done</i>
	Done	Refreshing done.	0
	Refresh	Refreshing.	1
51.28	<i>FBA A par table ver</i>	Displays the parameter table revision of the fieldbus adapter module mapping file (stored in the memory of the drive). In format axyz, where ax = major table revision number; yz = minor table revision number. This parameter is read-only.	-
		Parameter table revision of adapter module.	-
51.29	<i>FBA A drive type code</i>	Displays the drive type code in the fieldbus adapter module mapping file (stored in the memory of the drive). This parameter is read-only.	-
	0...65535	Drive type code stored in the mapping file.	1 = 1
51.30	<i>FBA A mapping file ver</i>	Displays the fieldbus adapter module mapping file revision stored in the memory of the drive in decimal format. This parameter is read-only.	-
	0...65535	Mapping file revision.	1 = 1

No.	Name/Value	Description	Def/FbEq16
51.31	<i>D2FBA A comm status</i>	Displays the status of the fieldbus adapter module communication.	-
	Not configured	Adapter is not configured.	0
	Initializing	Adapter is initializing.	1
	Time out	A timeout has occurred in the communication between the adapter and the drive.	2
	Configuration error	Adapter configuration error: mapping file not found in the file system of the drive, or mapping file upload has failed more than three times.	3
	Off-line	Fieldbus communication is off-line.	4
	On-line	Fieldbus communication is on-line, or fieldbus adapter has been configured not to detect a communication break. For more information, see the documentation of the fieldbus adapter.	5
	Reset	Adapter is performing a hardware reset.	6
51.32	<i>FBA A comm SW ver</i>	Displays the patch and build versions of the adapter module firmware in format xxyy, where xx = patch version number, yy = build version number. Example: C802 = 200.02 (patch version 200, build version 2).	
		Patch and build versions of adapter module firmware.	-
51.33	<i>FBA A appl SW ver</i>	Displays the major and minor versions of the adapter module firmware in format xyy, where x = major revision number, yy = minor revision number. Example: 300 = 3.00 (major version 3, minor version 00).	
		Major and minor versions of adapter module firmware.	-
52 FBA A data in		Selection of data to be transferred from drive to fieldbus controller through fieldbus adapter A. Note: 32-bit values require two consecutive parameters. Whenever a 32-bit value is selected in a data parameter, the next parameter is automatically reserved.	
52.01	<i>FBA A data in 1</i>	Parameters <i>52.01...52.12</i> select data to be transferred from the drive to the fieldbus controller through fieldbus adapter A.	<i>None</i>
	None	None.	0
	CW 16bit	Control Word (16 bits)	1
	Ref1 16bit	Reference REF1 (16 bits)	2
	Ref2 16bit	Reference REF2 (16 bits)	3
	SW 16bit	Status Word (16 bits)	4

No.	Name/Value	Description	Def/FbEq16
	Act1 16bit	Actual value ACT1 (16 bits)	5
	Act2 16bit	Actual value ACT2 (16 bits)	6
	CW 32bit	Control Word (32 bits)	11
	Ref1 32bit	Reference REF1 (32 bits)	12
	Ref2 32bit	Reference REF2 (32 bits)	13
	SW 32bit	Status Word (32 bits)	14
	Act1 32bit	Actual value ACT1 (32 bits)	15
	Act2 32bit	Actual value ACT2 (32 bits)	16
	SW2 16bit	Status Word 2 (16 bits)	24
	<i>Other</i>	Source selection (see <i>Terms and abbreviations</i> on page 90).	-
...
52.12	<i>FBA A data in12</i>	See parameter <i>52.01 FBA A data in1.</i>	<i>None</i>

<i>53 FBA A data out</i>	Selection of data to be transferred from fieldbus controller to drive through fieldbus adapter A. Note: 32-bit values require two consecutive parameters. Whenever a 32-bit value is selected in a data parameter, the next parameter is automatically reserved.		
<i>53.01 FBA A data out1</i>	Parameters <i>53.01...53.12</i> select data to be transferred from the fieldbus controller to the drive through fieldbus adapter A.	<i>None</i>	
	None	0	
	CW 16bit	1	
	Ref1 16bit	2	
	Ref2 16bit	3	
	CW 32bit	11	
	Ref1 32bit	12	
	Ref2 32bit	13	
	CW2 16bit	21	
	<i>Other</i>	Source selection (see <i>Terms and abbreviations</i> on page 90).	-
...	
<i>53.12 FBA A data out12</i>	See parameter <i>53.01 FBA A data out1.</i>	<i>None</i>	

No.	Name/Value	Description	Def/FbEq16
54 FBA B settings		Fieldbus adapter B configuration.	
54.01	FBA B type	Displays the type of the connected fieldbus adapter module. 0 = Module is not found or is not properly connected, or is disabled by parameter 50.31 FBA B enable ; 1 = FPBA; 32 = FCAN; 37 = FDNA; 101 = FCNA, 128 = FENA-11/21; 135 = FECA; 136 = FEPL; 485 = FSCA. This parameter is read-only.	-
54.02	FBA B Par2	Parameters 54.02...54.26 are adapter module-specific. For more information, see the documentation of the fieldbus adapter module. Note that not all of these parameters are necessarily in use.	-
	0...65535	Fieldbus adapter configuration parameter.	1 = 1
...
54.26	FBA B Par26	See parameter 54.02 FBA B Par2 .	-
	0...65535	Fieldbus adapter configuration parameter.	1 = 1
54.27	FBA B par refresh	Validates any changed fieldbus adapter module configuration settings. After refreshing, the value reverts automatically to Done . Note: This parameter cannot be changed while the drive is running.	Done
	Done	Refreshing done.	0
	Refresh	Refreshing.	1
54.28	FBA B par table ver	Displays the parameter table revision of the fieldbus adapter module mapping file (stored in the memory of the drive). In format axyz, where ax = major table revision number; yz = minor table revision number. This parameter is read-only.	-
		Parameter table revision of adapter module.	-
54.29	FBA B drive type code	Displays the drive type code in the fieldbus adapter module mapping file (stored in the memory of the drive). This parameter is read-only.	-
	0...65535	Drive type code stored in the mapping file.	1 = 1
54.30	FBA B mapping file ver	Displays the fieldbus adapter module mapping file revision stored in the memory of the drive in decimal format. This parameter is read-only.	-
	0...65535	Mapping file revision.	1 = 1

No.	Name/Value	Description	Def/FbEq16
54.31	<i>D2FBA B comm status</i>	Displays the status of the fieldbus adapter module communication.	-
	Not configured	Adapter is not configured.	0
	Initializing	Adapter is initializing.	1
	Time out	A timeout has occurred in the communication between the adapter and the drive.	2
	Configuration error	Adapter configuration error: mapping file not found in the file system of the drive, or mapping file upload has failed more than three times.	3
	Off-line	Fieldbus communication is off-line.	4
	On-line	Fieldbus communication is on-line, or fieldbus adapter has been configured not to detect a communication break. For more information, see the documentation of the fieldbus adapter.	5
	Reset	Adapter is performing a hardware reset.	6
54.32	<i>FBA B comm SW ver</i>	Displays the patch and build versions of the adapter module firmware in format xxyy, where xx = patch version number, yy = build version number. Example: C802 = 200.02 (patch version 200, build version 2).	
		Patch and build versions of adapter module firmware.	-
54.33	<i>FBA B appl SW ver</i>	Displays the major and minor versions of the adapter module firmware in format xyy, where x = major revision number, yy = minor revision number. Example: 300 = 3.00 (major version 3, minor version 00).	
		Major and minor versions of adapter module firmware.	-
55 FBA B data in		Selection of data to be transferred from drive to fieldbus controller through fieldbus adapter B.	
55.01	<i>FBA B data in1</i>	Parameters 55.01 ... 55.12 select data to be transferred from the drive to the fieldbus controller through fieldbus adapter B.	<i>None</i>
	None	None.	0
	CW 16bit	Control Word (16 bits)	1
	Ref1 16bit	Reference REF1 (16 bits)	2
	Ref2 16bit	Reference REF2 (16 bits)	3
	SW 16bit	Status Word (16 bits)	4
	Act1 16bit	Actual value ACT1 (16 bits)	5
	Act2 16bit	Actual value ACT2 (16 bits)	6
	CW 32bit	Control Word (32 bits)	11

No.	Name/Value	Description	Def/FbEq16
	Ref1 32bit	Reference REF1 (32 bits)	12
	Ref2 32bit	Reference REF2 (32 bits)	13
	SW 32bit	Status Word (32 bits)	14
	Act1 32bit	Actual value ACT1 (32 bits)	15
	Act2 32bit	Actual value ACT2 (32 bits)	16
	SW2 16bit	Status Word 2 (16 bits)	24
	<i>Other</i>	Source selection (see <i>Terms and abbreviations</i> on page 90).	-
...
55.12	<i>FBA B data in12</i>	See parameter 55.01 <i>FBA B data in1</i> .	<i>None</i>



56 FBA B data out		Selection of data to be transferred from fieldbus controller to drive through fieldbus adapter B.	
56.01	<i>FBA B data out1</i>	Parameters 56.01...56.12 select data to be transferred from the fieldbus controller to the drive through fieldbus adapter B.	<i>None</i>
	None	None.	0
	CW 16bit	Control Word (16 bits)	1
	Ref1 16bit	Reference REF1 (16 bits)	2
	Ref2 16bit	Reference REF2 (16 bits)	3
	CW 32bit	Control Word (32 bits)	11
	Ref1 32bit	Reference REF1 (32 bits)	12
	Ref2 32bit	Reference REF2 (32 bits)	13
	CW2 16bit	Control Word 2 (16 bits)	21
	<i>Other</i>	Source selection (see <i>Terms and abbreviations</i> on page 90).	-
...
56.12	<i>FBA B data out12</i>	See parameter 56.01 <i>FBA B data out1</i> .	<i>None</i>

58 Embedded fieldbus		Configuration of the embedded fieldbus (EFB) interface. See also chapter <i>Fieldbus control through the embedded fieldbus interface (EFB)</i> (page 527).	
58.01	<i>Protocol enable</i>	Enables/disables the embedded fieldbus interface and selects the protocol to use. Note: When the embedded fieldbus interface is enabled, the drive-to-drive link functionality is automatically disabled.	<i>None</i>
	None	None (communication disabled).	0
	Modbus RTU	Embedded fieldbus interface is enabled and uses the Modbus RTU protocol.	1

No.	Name/Value	Description	Def/FbEq16
58.02	Protocol ID	Displays the protocol ID and revision. This parameter is read-only.	-
		Protocol ID and revision.	1 = 1
58.03	Node address	Defines the node address of the drive on the fieldbus link. Values 1...247 are allowable. Two devices with the same address are not allowed on-line. Changes to this parameter take effect after the control unit is rebooted or the new settings validated by parameter 58.06 Communication control .	1
	0...255	Node address (values 1...247 are allowable).	1 = 1
58.04	Baud rate	Selects the transfer rate of the fieldbus link. Changes to this parameter take effect after the control unit is rebooted or the new settings validated by parameter 58.06 Communication control .	19.2 kbps
	9.6 kbps	9.6 kbit/s.	2
	19.2 kbps	19.2 kbit/s.	3
	38.4 kbps	38.4 kbit/s.	4
	57.6 kbps	57.6 kbit/s.	5
	76.8 kbps	76.8 kbit/s.	6
	115.2 kbps	115.2 kbit/s.	7
58.05	Parity	Selects the type of parity bit and the number of stop bits. Changes to this parameter take effect after the control unit is rebooted or the new settings validated by parameter 58.06 Communication control .	8 EVEN 1
	8 NONE 1	Eight data bits, no parity bit, one stop bit.	0
	8 NONE 2	Eight data bits, no parity bit, two stop bits.	1
	8 EVEN 1	Eight data bits, even parity bit, one stop bit.	2
	8 ODD 1	Eight data bits, odd parity bit, one stop bit.	3
58.06	Communication control	Validates any changes in the EFB settings, or activates silent mode.	Enabled
	Enabled	Normal operation.	0
	Refresh settings	Validates any changed EFB configuration settings. Reverts automatically to Enabled .	1
	Silent mode	Activates silent mode (no messages are transmitted). Silent mode can be terminated by activating the Refresh settings selection of this parameter.	2

No.	Name/Value	Description	Def/FbEq16																																																			
58.07	<i>Communication diagnostics</i>	Displays the status of the EFB communication. This parameter is read-only.	-																																																			
		<table border="1"> <thead> <tr> <th>Bit</th> <th>Name</th> <th>Description</th> </tr> </thead> <tbody> <tr> <td>0</td> <td>Init failed</td> <td>1 = EFB initialization failed</td> </tr> <tr> <td>1</td> <td>Addr config err</td> <td>1 = Node address not allowed by protocol</td> </tr> <tr> <td>2</td> <td>Silent mode</td> <td>1 = Drive not allowed to transmit 0 = Drive allowed to transmit</td> </tr> <tr> <td>3</td> <td>Autobauding</td> <td>Reserved</td> </tr> <tr> <td>4</td> <td>Wiring error</td> <td>1 = Errors detected (A/B wires possibly swapped)</td> </tr> <tr> <td>5</td> <td>Parity error</td> <td>1 = Error detected: check parameters 58.04 and 58.05</td> </tr> <tr> <td>6</td> <td>Baud rate error</td> <td>1 = Error detected: check parameters 58.05 and 58.04</td> </tr> <tr> <td>7</td> <td>No bus activity</td> <td>1 = 0 bytes received during last 5 seconds</td> </tr> <tr> <td>8</td> <td>No packets</td> <td>1 = 0 packets (addressed to any device) detected during last 5 seconds</td> </tr> <tr> <td>9</td> <td>Noise or addressing error</td> <td>1 = Errors detected (interference, or another device with the same address on line)</td> </tr> <tr> <td>10</td> <td>Comm loss</td> <td>1 = 0 packets addressed to the drive received within timeout (58.16)</td> </tr> <tr> <td>11</td> <td>CW/Ref loss</td> <td>1 = No control word or references received within timeout (58.16)</td> </tr> <tr> <td>12</td> <td>Not active</td> <td>Reserved</td> </tr> <tr> <td>13</td> <td>Protocol 1</td> <td>Reserved</td> </tr> <tr> <td>14</td> <td>Protocol 2</td> <td>Reserved</td> </tr> <tr> <td>15</td> <td>Internal error</td> <td>Reserved</td> </tr> </tbody> </table>	Bit	Name	Description	0	Init failed	1 = EFB initialization failed	1	Addr config err	1 = Node address not allowed by protocol	2	Silent mode	1 = Drive not allowed to transmit 0 = Drive allowed to transmit	3	Autobauding	Reserved	4	Wiring error	1 = Errors detected (A/B wires possibly swapped)	5	Parity error	1 = Error detected: check parameters 58.04 and 58.05	6	Baud rate error	1 = Error detected: check parameters 58.05 and 58.04	7	No bus activity	1 = 0 bytes received during last 5 seconds	8	No packets	1 = 0 packets (addressed to any device) detected during last 5 seconds	9	Noise or addressing error	1 = Errors detected (interference, or another device with the same address on line)	10	Comm loss	1 = 0 packets addressed to the drive received within timeout (58.16)	11	CW/Ref loss	1 = No control word or references received within timeout (58.16)	12	Not active	Reserved	13	Protocol 1	Reserved	14	Protocol 2	Reserved	15	Internal error	Reserved	
Bit	Name	Description																																																				
0	Init failed	1 = EFB initialization failed																																																				
1	Addr config err	1 = Node address not allowed by protocol																																																				
2	Silent mode	1 = Drive not allowed to transmit 0 = Drive allowed to transmit																																																				
3	Autobauding	Reserved																																																				
4	Wiring error	1 = Errors detected (A/B wires possibly swapped)																																																				
5	Parity error	1 = Error detected: check parameters 58.04 and 58.05																																																				
6	Baud rate error	1 = Error detected: check parameters 58.05 and 58.04																																																				
7	No bus activity	1 = 0 bytes received during last 5 seconds																																																				
8	No packets	1 = 0 packets (addressed to any device) detected during last 5 seconds																																																				
9	Noise or addressing error	1 = Errors detected (interference, or another device with the same address on line)																																																				
10	Comm loss	1 = 0 packets addressed to the drive received within timeout (58.16)																																																				
11	CW/Ref loss	1 = No control word or references received within timeout (58.16)																																																				
12	Not active	Reserved																																																				
13	Protocol 1	Reserved																																																				
14	Protocol 2	Reserved																																																				
15	Internal error	Reserved																																																				
	0000h...FFFFh	EFB communication status.	1 = 1																																																			
58.08	<i>Received packets</i>	Displays a count of valid packets addressed to the drive. During normal operation, this number increases constantly. Can be reset from the control panel by keeping Reset depressed for over 3 seconds.	-																																																			
	0...4294967295	Number of received packets addressed to the drive.	1 = 1																																																			
58.09	<i>Transmitted packets</i>	Displays a count of valid packets transmitted by the drive. During normal operation, this number increases constantly. Can be reset from the control panel by keeping Reset depressed for over 3 seconds.	-																																																			
	0...4294967295	Number of transmitted packets.	1 = 1																																																			

No.	Name/Value	Description	Def/FbEq16
58.10	All packets	Displays a count of valid packets addressed to any device on the bus. During normal operation, this number increases constantly. Can be reset from the control panel by keeping Reset depressed for over 3 seconds.	-
	0...4294967295	Number of all received packets.	1 = 1
58.11	UART errors	Displays a count of character errors received by the drive. An increasing count indicates a configuration problem on the bus. Can be reset from the control panel by keeping Reset depressed for over 3 seconds.	-
	0...4294967295	Number of UART errors.	1 = 1
58.12	CRC errors	Displays a count of packets with a CRC error received by the drive. An increasing count indicates interference on the bus. Can be reset from the control panel by keeping Reset depressed for over 3 seconds.	-
	0...4294967295	Number of CRC errors.	1 = 1
58.14	Communication loss action	Selects how the drive reacts to an EFB communication break. Changes to this parameter take effect after the control unit is rebooted or the new settings validated by parameter 58.06 Communication control . See also parameters 58.15 Communication loss mode and 58.16 Communication loss time .	Fault
	No	No action taken (monitoring disabled).	0
	Fault	Drive trips on 6681 EFB comm loss . This only occurs if control is expected from the EFB (EFB selected as source of start/stop in the currently active location).	1
	Last speed	Drive generates an A7CE EFB comm loss warning and freezes the speed to the level the drive was operating at. This only occurs if control is expected from the EFB. The speed is determined on the basis of actual speed using 850 ms low-pass filtering.  WARNING! Make sure that it is safe to continue operation in case of a communication break.	2

No.	Name/Value	Description	Def/FbEq16
	Speed ref safe	Drive generates an <i>A7CE EFB comm loss</i> warning and sets the speed to the speed defined by parameter <i>22.41 Speed ref safe</i> (or <i>28.41 Frequency ref safe</i> when frequency reference is being used). This only occurs if control is expected from the EFB.  WARNING! Make sure that it is safe to continue operation in case of a communication break.	3
	Fault always	Drive trips on <i>6681 EFB comm loss</i> . This occurs even though no control is expected from the EFB.	4
	Warning	Drive generates an <i>A7CE EFB comm loss</i> warning. This occurs even though no control is expected from the EFB.  WARNING! Make sure that it is safe to continue operation in case of a communication break.	5
58.15	<i>Communication loss mode</i>	Defines which message types reset the timeout counter for detecting an EFB communication loss. Changes to this parameter take effect after the control unit is rebooted or the new settings validated by parameter <i>58.06 Communication control</i> . See also parameters <i>58.14 Communication loss action</i> and <i>58.16 Communication loss time</i> .	<i>Cw / Ref1 / Ref2</i>
	Any message	Any message addressed to the drive resets the timeout.	1
	Cw / Ref1 / Ref2	A write of the control word or a reference from the fieldbus resets the timeout.	2
58.16	<i>Communication loss time</i>	Sets a timeout for EFB communication. If a communication break lasts longer than the timeout, the action specified by parameter <i>58.14 Communication loss action</i> is taken. Changes to this parameter take effect after the control unit is rebooted or the new settings validated by parameter <i>58.06 Communication control</i> . See also parameter <i>58.15 Communication loss mode</i> .	3.0 s
	0.0 ... 6000.0 s	EFB communication timeout.	1 = 1

No.	Name/Value	Description	Def/FbEq16										
58.17	<i>Transmit delay</i>	Defines a minimum response delay in addition to any fixed delay imposed by the protocol. Changes to this parameter take effect after the control unit is rebooted or the new settings validated by parameter 58.06 Communication control .	0 ms										
	0...65535 ms	Minimum response delay.	1 = 1										
58.18	<i>EFB control word</i>	Displays the raw (unmodified) control word sent by the Modbus controller to the drive. For debugging purposes. This parameter is read-only.	-										
	0000h...FFFFh	Control word sent by Modbus controller to the drive.	1 = 1										
58.19	<i>EFB status word</i>	Displays the raw (unmodified) status word sent by the drive to the Modbus controller. For debugging purposes. This parameter is read-only.	-										
	0000h...FFFFh	Status word sent by the drive to the Modbus controller.	1 = 1										
58.25	<i>Control profile</i>	Defines the control profile used by the protocol.	<i>ABB Drives</i>										
	ABB Drives	ABB Drives profile (with a 16-bit control word) with registers in the classic format for backward compatibility.	0										
	Transparent	Transparent profile (16-bit or 32-bit control word) with registers in the classic format.	2										
58.26	<i>EFB ref1 type</i>	Selects the type and scaling of reference 1 received through the embedded fieldbus interface. The scaled reference is displayed by 03.09 EFB reference 1 .	<i>Speed or frequency</i>										
	Speed or frequency	Type and scaling are chosen automatically according to the currently active operation mode as follows:	0										
<table border="1"> <thead> <tr> <th>Operation mode (see par. 19.01)</th> <th>Reference type</th> <th>Scaling</th> </tr> </thead> <tbody> <tr> <td>Speed control</td> <td rowspan="2"><i>Speed</i></td> <td rowspan="2"><i>46.01 Speed scaling</i></td> </tr> <tr> <td>Torque control</td> </tr> <tr> <td>Frequency control</td> <td><i>Frequency</i></td> <td><i>46.02 Frequency scaling</i></td> </tr> </tbody> </table>				Operation mode (see par. 19.01)	Reference type	Scaling	Speed control	<i>Speed</i>	<i>46.01 Speed scaling</i>	Torque control	Frequency control	<i>Frequency</i>	<i>46.02 Frequency scaling</i>
Operation mode (see par. 19.01)	Reference type	Scaling											
Speed control	<i>Speed</i>	<i>46.01 Speed scaling</i>											
Torque control													
Frequency control	<i>Frequency</i>	<i>46.02 Frequency scaling</i>											
	Transparent	No scaling is applied.	1										
	General	Generic reference with a scaling of 100 = 1 (ie. integer and two decimals).	2										
	Torque	The scaling is defined by parameter 46.03 Torque scaling .	3										

No.	Name/Value	Description	Def/FbEq16										
	Speed	The scaling is defined by parameter 46.01 Speed scaling .	4										
	Frequency	The scaling is defined by parameter 46.02 Frequency scaling .	5										
58.27	EFB ref2 type	Selects the type and scaling of reference 2 received through the embedded fieldbus interface. The scaled reference is displayed by 03.10 EFB reference 2 . For the selections, see parameter 58.26 EFB ref1 type .	Torque										
58.28	EFB act1 type	Selects the type/source and scaling of actual value 1 transmitted to the fieldbus network through the embedded fieldbus interface.	Speed or frequency										
	Speed or frequency	Type/source and scaling are chosen automatically according to the currently active operation mode as follows:	0										
<table border="1"> <thead> <tr> <th>Operation mode (see par. 19.01)</th> <th>Actual 1 type (source)</th> <th>Scaling</th> </tr> </thead> <tbody> <tr> <td>Speed control</td> <td rowspan="2" style="text-align: center;">Speed (01.01 Motor speed used)</td> <td rowspan="2" style="text-align: center;">46.01 Speed scaling</td> </tr> <tr> <td>Torque control</td> </tr> <tr> <td>Frequency control</td> <td style="text-align: center;">Frequency (01.06 Output frequency)</td> <td style="text-align: center;">46.02 Frequency scaling</td> </tr> </tbody> </table>				Operation mode (see par. 19.01)	Actual 1 type (source)	Scaling	Speed control	Speed (01.01 Motor speed used)	46.01 Speed scaling	Torque control	Frequency control	Frequency (01.06 Output frequency)	46.02 Frequency scaling
Operation mode (see par. 19.01)	Actual 1 type (source)	Scaling											
Speed control	Speed (01.01 Motor speed used)	46.01 Speed scaling											
Torque control													
Frequency control	Frequency (01.06 Output frequency)	46.02 Frequency scaling											
	Transparent	The value selected by parameter 58.31 EFB act1 transparent source is sent as actual value 1. No scaling is applied (the 16-bit scaling is 1 = 1 unit).	1										
	General	The value selected by parameter 58.31 EFB act1 transparent source is sent as actual value 1 with a 16-bit scaling of 100 = 1 unit (ie. integer and two decimals).	2										
	Torque	01.10 Motor torque is sent as actual value 1. The scaling is defined by parameter 46.03 Torque scaling .	3										
	Speed	01.01 Motor speed used is sent as actual value 1. The scaling is defined by parameter 46.01 Speed scaling .	4										
	Frequency	01.06 Output frequency is sent as actual value 1. The scaling is defined by parameter 46.02 Frequency scaling .	5										
	Position	Motor position is sent as actual value 1. See parameter 90.06 Motor position scaled .	6										

No.	Name/Value	Description	Def/FbEq16												
58.29	<i>EFB act2 type</i>	Selects the type/source and scaling of actual value 2 transmitted to the fieldbus network through the embedded fieldbus interface.	<i>Torque</i>												
	Speed or frequency	Type/source and scaling are chosen automatically according to the currently active operation mode as follows:	0												
		<table border="1"> <thead> <tr> <th>Operation mode (see par. 19.01)</th> <th>Actual 2 type (source)</th> <th>Scaling</th> </tr> </thead> <tbody> <tr> <td>Speed control</td> <td><i>Speed</i> (01.01 Motor speed used)</td> <td>46.01 Speed scaling</td> </tr> <tr> <td>Torque control</td> <td></td> <td></td> </tr> <tr> <td>Frequency control</td> <td><i>Frequency</i> (01.06 Output frequency)</td> <td>46.02 Frequency scaling</td> </tr> </tbody> </table>	Operation mode (see par. 19.01)	Actual 2 type (source)	Scaling	Speed control	<i>Speed</i> (01.01 Motor speed used)	46.01 Speed scaling	Torque control			Frequency control	<i>Frequency</i> (01.06 Output frequency)	46.02 Frequency scaling	
Operation mode (see par. 19.01)	Actual 2 type (source)	Scaling													
Speed control	<i>Speed</i> (01.01 Motor speed used)	46.01 Speed scaling													
Torque control															
Frequency control	<i>Frequency</i> (01.06 Output frequency)	46.02 Frequency scaling													
	Transparent	The value selected by parameter 58.32 <i>EFB act2 transparent source</i> is sent as actual value 2. No scaling is applied (the 16-bit scaling is 1 = 1 unit).	1												
	General	The value selected by parameter 58.32 <i>EFB act2 transparent source</i> is sent as actual value 2 with a 16-bit scaling of 100 = 1 unit (ie. integer and two decimals).	2												
	Torque	01.10 <i>Motor torque</i> is sent as actual value 2. The scaling is defined by parameter 46.03 <i>Torque scaling</i> .	3												
	Speed	01.01 <i>Motor speed used</i> is sent as actual value 2. The scaling is defined by parameter 46.01 <i>Speed scaling</i> .	4												
	Frequency	01.06 <i>Output frequency</i> is sent as actual value 2. The scaling is defined by parameter 46.02 <i>Frequency scaling</i> .	5												
	Position	Motor position is sent as actual value 2. See parameter 90.06 <i>Motor position scaled</i> .	6												
58.30	<i>EFB status word transparent source</i>	Selects the source of the status word when 58.25 <i>Control profile</i> is set to <i>Transparent</i> .	<i>Not selected</i>												
	Not selected	None.	0												
	<i>Other</i>	Source selection (see <i>Terms and abbreviations</i> on page 90).	-												
58.31	<i>EFB act1 transparent source</i>	Selects the source of actual value 1 when 58.28 <i>EFB act1 type</i> is set to <i>Transparent</i> or <i>General</i> .	<i>Not selected</i>												
	Not selected	None.	0												
	<i>Other</i>	Source selection (see <i>Terms and abbreviations</i> on page 90).	-												

No.	Name/Value	Description	Def/FbEq16
58.32	<i>EFB act2 transparent source</i>	Selects the source of actual value 1 when <i>58.29 EFB act2 type</i> is set to <i>Transparent</i> or <i>General</i> .	<i>Not selected</i>
	Not selected	None.	0
	<i>Other</i>	Source selection (see <i>Terms and abbreviations</i> on page 90).	-
58.33	<i>Addressing mode</i>	Defines the mapping between parameters and holding registers in the 400101...465535 Modbus register range. Changes to this parameter take effect after the control unit is rebooted or the new settings validated by parameter <i>58.06 Communication control</i> .	<i>Mode 0</i>
	Mode 0	<u>16-bit values (groups 1...99, indexes 1...99):</u> Register address = 400000 + 100 × parameter group + parameter index. For example, parameter 22.80 would be mapped to register 400000 + 2200 + 80 = 402280. <u>32-bit values (groups 1...99, indexes 1...99):</u> Register address = 420000 + 200 × parameter group + 2 × parameter index. For example, parameter 22.80 would be mapped to register 420000 + 4400 + 160 = 424560.	0
	Mode 1	<u>16-bit values (groups 1...255, indexes 1...255):</u> Register address = 400000 + 256 × parameter group + parameter index. For example, parameter 22.80 would be mapped to register 400000 + 5632 + 80 = 405712.	1
	Mode 2	<u>32-bit values (groups 1...127, indexes 1...255):</u> Register address = 400000 + 512 × parameter group + 2 × parameter index. For example, parameter 22.80 would be mapped to register 400000 + 11264 + 160 = 411424.	2
58.34	<i>Word order</i>	Selects in which order 16-bit registers of 32-bit parameters are transferred. For each register, the first byte contains the high order byte and the second byte contains the low order byte. Changes to this parameter take effect after the control unit is rebooted or the new settings validated by parameter <i>58.06 Communication control</i> .	<i>LO-HI</i>
	HI-LO	The first register contains the high order word, the second contains the low order word.	0

No.	Name/Value	Description	Def/FbEq16															
	LO-HI	The first register contains the low order word, the second contains the high order word.	1															
58.36	<i>EFB comm supervision force</i>	<p>Activates fieldbus communication monitoring separately for each control location (see section Local control vs. external control on page 26).</p> <p>The parameter is primarily intended for monitoring the communication with EFB when it is connected to the application program and not selected as a control source by drive parameters.</p>	0000b															
<table border="1"> <thead> <tr> <th>Bit</th> <th>Name</th> <th>Value</th> </tr> </thead> <tbody> <tr> <td>0</td> <td>Ext 1</td> <td>1 = Communication monitoring active when Ext 1 is being used.</td> </tr> <tr> <td>1</td> <td>Ext 2</td> <td>1 = Communication monitoring active when Ext 2 is being used.</td> </tr> <tr> <td>2</td> <td>Local</td> <td>1 = Communication monitoring active when local control is being used.</td> </tr> <tr> <td>3...15</td> <td colspan="2">Reserved</td> </tr> </tbody> </table>				Bit	Name	Value	0	Ext 1	1 = Communication monitoring active when Ext 1 is being used.	1	Ext 2	1 = Communication monitoring active when Ext 2 is being used.	2	Local	1 = Communication monitoring active when local control is being used.	3...15	Reserved	
Bit	Name	Value																
0	Ext 1	1 = Communication monitoring active when Ext 1 is being used.																
1	Ext 2	1 = Communication monitoring active when Ext 2 is being used.																
2	Local	1 = Communication monitoring active when local control is being used.																
3...15	Reserved																	
	0000b...0111b	EFB communication monitoring selection.	1 = 1															
58.101	<i>Data I/O 1</i>	<p>Defines the address in the drive which the Modbus master accesses when it reads from or writes to register address 400001.</p> <p>The master defines the type of the data (input or output). The value is transmitted in a Modbus frame consisting of two 16-bit words. If the value is 16-bit, it is transmitted in the LSW (least significant word). If the value is 32-bit, the subsequent parameter is also reserved for it and must be set to <i>None</i>.</p>	<i>CW 16bit</i>															
	None	None.	0															
	CW 16bit	Control Word (16 bits).	1															
	Ref1 16bit	Reference REF1 (16 bits).	2															
	Ref2 16bit	Reference REF2 (16 bits).	3															
	SW 16bit	Status Word (16 bits).	4															
	Act1 16bit	Actual value ACT1 (16 bits).	5															
	Act2 16bit	Actual value ACT2 (16 bits).	6															
	CW 32bit	Control Word (32 bits).	11															
	Ref1 32bit	Reference REF1 (32 bits).	12															
	Ref2 32bit	Reference REF2 (32 bits).	13															
	SW 32bit	Status Word (32 bits).	14															
	Act1 32bit	Actual value ACT1 (32 bits).	15															
	Act2 32bit	Actual value ACT2 (32 bits).	16															

No.	Name/Value	Description	Def/FbEq16
	CW2 16bit	Control Word 2 (16 bits). When a 32-bit control word is used, this setting means the most-significant 16 bits.	21
	SW2 16bit	Status Word 2 (16 bits). When a 32-bit control word is used, this setting means the most-significant 16 bits.	24
	RO/DIO control word	Parameter 10.99 RO/DIO control word .	31
	AO1 data storage	Parameter 13.91 AO1 data storage .	32
	AO2 data storage	Parameter 13.92 AO2 data storage .	33
	<i>Other</i>	Source selection (see Terms and abbreviations on page 90).	-
58.102	Data I/O 2	Defines the address in the drive which the Modbus master accesses when it reads from or writes to register address 400002. For the selections, see parameter 58.101 Data I/O 1 .	Ref1 16bit
58.103	Data I/O 3	Defines the address in the drive which the Modbus master accesses when it reads from or writes to register address 400003. For the selections, see parameter 58.101 Data I/O 1 .	Ref2 16bit
58.104	Data I/O 4	Defines the address in the drive which the Modbus master accesses when it reads from or writes to register address 400004. For the selections, see parameter 58.101 Data I/O 1 .	SW 16bit
58.105	Data I/O 5	Defines the address in the drive which the Modbus master accesses when it reads from or writes to register address 400005. For the selections, see parameter 58.101 Data I/O 1 .	Act1 16bit
58.106	Data I/O 6	Defines the address in the drive which the Modbus master accesses when it reads from or writes to register address 400006. For the selections, see parameter 58.101 Data I/O 1 .	Act2 16bit
58.107	Data I/O 7	Parameter selector for Modbus register address 400007. For the selections, see parameter 58.101 Data I/O 1 .	None
...

No.	Name/Value	Description	Def/FbEq16
58.124	Data I/O 24	Parameter selector for Modbus register address 400024. For the selections, see parameter 58.101 Data I/O 1 .	None
60 DDCS communication			
		DDCS communication configuration. The DDCS protocol is used in the communication between <ul style="list-style-type: none"> • drives in a master/follower configuration (see page 39) or • the drive (or more precisely, an inverter unit) and the supply unit of the drive system. All of the above utilize a fiber optic link which also requires an FDCO module (typically with ZCU control units). Master/follower and external controller communication can also be implemented through shielded twisted-pair cable connected to the XD2D connector of the drive.	
60.01	M/F communication port	Selects the connection used by the master/follower functionality.	Not in use
	Not in use	None (communication disabled).	0
	XD2D	Connector XD2D.	7
60.02	M/F node address	Selects the node address of the drive for master/follower communication. No two nodes on-line may have the same address. Note: The allowable addresses for the master are 0 and 1. The allowable addresses for followers are 2...60.	1
	1...254	Node address.	
60.03	M/F mode	Defines the role of the drive on the master/follower link.	Not in use
	Not in use	Master/follower functionality not active.	0
	D2D master	The drive is the master on the drive-to-drive (D2D) link.	3
	D2D follower	The drive is a follower on the drive-to-drive (D2D) link.	4
	D2D forcing	The role of the drive on the drive-to-drive (D2D) link is defined by parameters 60.15 Force master and 60.16 Force follower .	6
60.05	M/F HW connection	Selects the topology of the master/follower link.	Ring
	Ring	The devices are connected in a ring topology. Forwarding of messages is enabled.	0

No.	Name/Value	Description	Def/FbEq16										
60.08	<i>M/F comm loss timeout</i>	Sets a timeout for master/follower communication. If a communication break lasts longer than the timeout, the action specified by parameter 60.09 M/F comm loss function is taken. As a rule of thumb, this parameter should be set to at least 3 times the transmit interval of the master. See also parameter 60.19 M/F comm supervision sel 1 .	100 ms										
	0...65535 ms	Master/follower communication timeout.											
60.09	<i>M/F comm loss function</i>	Selects how the drive reacts to a master/follower communication break.	<i>Fault</i>										
	No action	No action taken.	0										
	Warning	The drive generates a warning (A7CB MF comm loss).	1										
	Fault	Drive trips on 7582 MF comm loss .	2										
	Fault always	Drive trips on 7582 MF comm loss . This occurs even though no control is expected from the master/follower link.	3										
60.10	<i>M/F ref1 type</i>	Selects the type and scaling of reference 1 received from the master/follower link. The scaling of the reference is defined by parameters 46.01...46.04 , depending on which reference type is selected by this parameter. The resulting value is shown by 03.13 M/F or D2D ref1 .	<i>Speed or frequency</i>										
	Speed or frequency	Type and scaling are chosen automatically according to the currently active operation mode as follows:	0										
	<table border="1"> <thead> <tr> <th>Operation mode (see par. 19.01)</th> <th>Reference type</th> <th>Scaling</th> </tr> </thead> <tbody> <tr> <td>Speed control</td> <td rowspan="2"><i>Speed</i></td> <td rowspan="2">46.01 Speed scaling</td> </tr> <tr> <td>Torque control</td> </tr> <tr> <td>Frequency control</td> <td><i>Frequency</i></td> <td>46.02 Frequency scaling</td> </tr> </tbody> </table>			Operation mode (see par. 19.01)	Reference type	Scaling	Speed control	<i>Speed</i>	46.01 Speed scaling	Torque control	Frequency control	<i>Frequency</i>	46.02 Frequency scaling
Operation mode (see par. 19.01)	Reference type	Scaling											
Speed control	<i>Speed</i>	46.01 Speed scaling											
Torque control													
Frequency control	<i>Frequency</i>	46.02 Frequency scaling											
	Transparent	No scaling is applied.	1										
	General	Generic reference with a scaling of 100 = 1 (ie. integer and two decimals).	2										
	Torque	The scaling is defined by parameter 46.03 Torque scaling .	3										
	Speed	The scaling is defined by parameter 46.01 Speed scaling .	4										
	Frequency	The scaling is defined by parameter 46.02 Frequency scaling .	5										

No.	Name/Value	Description	Def/FbEq16												
60.11	<i>M/F ref2 type</i>	Selects the type and scaling of reference 2 received from the master/follower link. The scaling of the reference is defined by parameters <i>46.01...46.04</i> , depending on which reference type is selected by this parameter. The resulting value is shown by <i>03.14 M/F or D2D ref2</i> . For the selections, see parameter <i>60.10 M/F ref1 type</i> .	<i>Torque</i>												
60.12	<i>M/F act1 type</i>	Selects the type/source and scaling of actual value ACT1 transmitted to the master/follower link.	<i>Speed or frequency</i>												
	Speed or frequency	Type/source and scaling are chosen automatically according to the currently active operation mode as follows:	0												
<table border="1"> <thead> <tr> <th>Operation mode (see par. <i>19.01</i>)</th> <th>Actual 1 type (source)</th> <th>Scaling</th> </tr> </thead> <tbody> <tr> <td>Speed control</td> <td><i>Speed</i> (<i>01.01 Motor speed used</i>)</td> <td><i>46.01 Speed scaling</i></td> </tr> <tr> <td>Torque control</td> <td></td> <td></td> </tr> <tr> <td>Frequency control</td> <td><i>Frequency</i> (<i>01.06 Output frequency</i>)</td> <td><i>46.02 Frequency scaling</i></td> </tr> </tbody> </table>				Operation mode (see par. <i>19.01</i>)	Actual 1 type (source)	Scaling	Speed control	<i>Speed</i> (<i>01.01 Motor speed used</i>)	<i>46.01 Speed scaling</i>	Torque control			Frequency control	<i>Frequency</i> (<i>01.06 Output frequency</i>)	<i>46.02 Frequency scaling</i>
Operation mode (see par. <i>19.01</i>)	Actual 1 type (source)	Scaling													
Speed control	<i>Speed</i> (<i>01.01 Motor speed used</i>)	<i>46.01 Speed scaling</i>													
Torque control															
Frequency control	<i>Frequency</i> (<i>01.06 Output frequency</i>)	<i>46.02 Frequency scaling</i>													
	Transparent	Reserved.	1												
	General	Reserved.	2												
	Torque	<i>01.10 Motor torque</i> is sent as actual value 1. The scaling is defined by parameter <i>46.03 Torque scaling</i> .	3												
	Speed	<i>01.01 Motor speed used</i> is sent as actual value 1. The scaling is defined by parameter <i>46.01 Speed scaling</i> .	4												
	Frequency	<i>01.06 Output frequency</i> is sent as actual value 1. The scaling is defined by parameter <i>46.02 Frequency scaling</i> .	5												

No.	Name/Value	Description	Def/FbEq16												
60.13	<i>M/F act2 type</i>	Selects the type/source and scaling of actual value ACT2 transmitted to the master/follower link.	<i>Speed or frequency</i>												
	Speed or frequency	Type/source and scaling are chosen automatically according to the currently active operation mode as follows:	0												
		<table border="1"> <thead> <tr> <th>Operation mode (see par. 19.01)</th> <th>Actual 2 type (source)</th> <th>Scaling</th> </tr> </thead> <tbody> <tr> <td>Speed control</td> <td><i>Speed</i> (01.01 Motor speed used)</td> <td><i>46.01 Speed scaling</i></td> </tr> <tr> <td>Torque control</td> <td></td> <td></td> </tr> <tr> <td>Frequency control</td> <td><i>Frequency</i> (01.06 Output frequency)</td> <td><i>46.02 Frequency scaling</i></td> </tr> </tbody> </table>	Operation mode (see par. 19.01)	Actual 2 type (source)	Scaling	Speed control	<i>Speed</i> (01.01 Motor speed used)	<i>46.01 Speed scaling</i>	Torque control			Frequency control	<i>Frequency</i> (01.06 Output frequency)	<i>46.02 Frequency scaling</i>	
Operation mode (see par. 19.01)	Actual 2 type (source)	Scaling													
Speed control	<i>Speed</i> (01.01 Motor speed used)	<i>46.01 Speed scaling</i>													
Torque control															
Frequency control	<i>Frequency</i> (01.06 Output frequency)	<i>46.02 Frequency scaling</i>													
	Transparent	Reserved.	1												
	General	Reserved.	2												
	Torque	<i>01.10 Motor torque</i> is sent as actual value 2. The scaling is defined by parameter <i>46.03 Torque scaling</i> .	3												
	Speed	<i>01.01 Motor speed used</i> is sent as actual value 2. The scaling is defined by parameter <i>46.01 Speed scaling</i> .	4												
	Frequency	<i>01.06 Output frequency</i> is sent as actual value 2. The scaling is defined by parameter <i>46.02 Frequency scaling</i> .	5												
60.14	<i>M/F follower selection</i>	(Effective in the master only.) Defines the followers from which data is read. See also parameters <i>62.28...62.33</i> .	<i>None</i>												
	Follower node 2	Data is read from the follower with node address 2.	2												
	Follower node 3	Data is read from the follower with node address 3.	4												
	Follower node 4	Data is read from the follower with node address 4.	8												
	Follower nodes 2+3	Data is read from the followers with node addresses 2 and 3.	6												
	Follower nodes 2+4	Data is read from the followers with node addresses 2 and 4.	10												
	Follower nodes 3+4	Data is read from the followers with node addresses 3 and 4.	12												
	Follower nodes 2+3+4	Data is read from the followers with node addresses 2, 3 and 4.	14												
	None	None.	0												

No.	Name/Value	Description	Def/FbEq16
60.15	<i>Force master</i>	When parameter <i>60.03 M/F mode</i> is set to <i>D2D forcing</i> , this parameter selects a source that forces the drive to be the master on the master/follower link. 1 = Drive is master on the master/follower link	<i>FALSE</i>
	FALSE	0.	0
	TRUE	1.	1
	<i>Other [bit]</i>	Source selection (see <i>Terms and abbreviations</i> on page 90).	-
60.16	<i>Force follower</i>	When parameter <i>60.03 M/F mode</i> is set to <i>D2D forcing</i> , this parameter selects a source that forces the drive to be a follower on the master/follower link. 1 = Drive is follower on the master/follower link	<i>FALSE</i>
	FALSE	0.	0
	TRUE	1.	1
	<i>Other [bit]</i>	Source selection (see <i>Terms and abbreviations</i> on page 90).	-
60.17	<i>Follower fault action</i>	(Effective in the master only.) Selects how the drive reacts to a fault in a follower. See also parameter <i>60.23 M/F status supervision sel 1</i> . Note: Each follower must be configured to transmit its status word as one of the three data words in parameters <i>61.01...61.03</i> . In the master, the corresponding target parameter (<i>62.04...62.12</i>) must be set to <i>Follower SW</i> .	<i>Fault</i>
	No action	No action taken. Unaffected drives on the master/follower link will continue running.	0
	Warning	The drive generates a warning (<i>AFE7 Follower</i>).	1
	Fault	Drive trips on <i>FF7E Follower</i> . All followers will be stopped.	2
60.18	<i>Follower enable</i>	Interlocks the starting of the master to the status of the followers. See also parameter <i>60.23 M/F status supervision sel 1</i> . Note: Each follower must be configured to transmit its status word as one of the three data words in parameters <i>61.01...61.03</i> . In the master, the corresponding target parameter (<i>62.04...62.12</i>) must be set to <i>Follower SW</i> .	<i>Always</i>
	MSW bit 0	The master can only be started if all followers are ready to switch on (bit 0 of <i>06.11 Main status word</i> in each follower is on).	0

No.	Name/Value	Description	Def/FbEq16															
	MSW bit 1	The master can only be started if all followers are ready to operate (bit 1 of <i>06.11 Main status word</i> in each follower is on).	1															
	MSW bits 0 + 1	The master can only be started if all followers are ready to switch on and ready to operate (bits 0 and 1 of <i>06.11 Main status word</i> in each follower are on).	2															
	Always	The starting of the master is not interlocked to the status of the followers.	3															
	MSW bit 12	The master can only be started if user-definable bit 12 of <i>06.11 Main status word</i> in each follower is on. See parameter <i>06.31 MSW bit 12 sel</i> .	4															
	MSW bits 0 + 12	The master can only be started if both bit 0 and bit 12 of <i>06.11 Main status word</i> in each follower is on.	5															
	MSW bits 1 + 12	The master can only be started if both bit 1 and bit 12 of <i>06.11 Main status word</i> in each follower is on.	5															
60.19	<i>M/F comm supervision sel 1</i>	<p>(This parameter is only effective when the drive is the master on a drive-to-drive master/follower link. See parameters <i>60.01 M/F communication port</i> and <i>60.03 M/F mode</i>.)</p> <p>In the master, parameters <i>60.19 M/F comm supervision sel 1</i> and <i>60.20 M/F comm supervision sel 2</i> specify the followers that are monitored for loss of communication.</p> <p>This parameter selects which followers (out of followers 1...16) are monitored. Each of the selected followers is polled by the master. If no reply is received, the action specified in <i>60.09 M/F comm loss function</i> is taken.</p> <p>The status of communication is shown by <i>62.37 M/F communication status 1</i> and <i>62.38 M/F communication status 2</i>.</p>	-															
		<table border="1"> <thead> <tr> <th>Bit</th> <th>Name</th> <th>Description</th> </tr> </thead> <tbody> <tr> <td>0</td> <td>Follower 1</td> <td>1 = Follower 1 is polled by the master.</td> </tr> <tr> <td>1</td> <td>Follower 2</td> <td>1 = Follower 2 is polled by the master.</td> </tr> <tr> <td>...</td> <td>...</td> <td>...</td> </tr> <tr> <td>15</td> <td>Follower 16</td> <td>1 = Follower 16 is polled by the master.</td> </tr> </tbody> </table>	Bit	Name	Description	0	Follower 1	1 = Follower 1 is polled by the master.	1	Follower 2	1 = Follower 2 is polled by the master.	15	Follower 16	1 = Follower 16 is polled by the master.	
Bit	Name	Description																
0	Follower 1	1 = Follower 1 is polled by the master.																
1	Follower 2	1 = Follower 2 is polled by the master.																
...																
15	Follower 16	1 = Follower 16 is polled by the master.																
	0000h...FFFFh	Selection of followers for communication supervision (1).	1 = 1															

No.	Name/Value	Description	Def/FbEq16															
60.20	<i>M/F comm supervision sel 2</i>	Selects which followers (out of followers 17...32) are monitored for loss of communication. See parameter <i>60.19 M/F comm supervision sel 1</i> .	-															
<table border="1"> <thead> <tr> <th>Bit</th> <th>Name</th> <th>Description</th> </tr> </thead> <tbody> <tr> <td>0</td> <td>Follower 17</td> <td>1 = Follower 17 is polled by the master.</td> </tr> <tr> <td>1</td> <td>Follower 18</td> <td>1 = Follower 18 is polled by the master.</td> </tr> <tr> <td>...</td> <td>...</td> <td>...</td> </tr> <tr> <td>15</td> <td>Follower 32</td> <td>1 = Follower 32 is polled by the master.</td> </tr> </tbody> </table>				Bit	Name	Description	0	Follower 17	1 = Follower 17 is polled by the master.	1	Follower 18	1 = Follower 18 is polled by the master.	15	Follower 32	1 = Follower 32 is polled by the master.
Bit	Name	Description																
0	Follower 17	1 = Follower 17 is polled by the master.																
1	Follower 18	1 = Follower 18 is polled by the master.																
...																
15	Follower 32	1 = Follower 32 is polled by the master.																
0000h...FFFFh		Selection of followers for communication supervision (2).	1 = 1															
60.23	<i>M/F status supervision sel 1</i>	<p>(This parameter is only effective when the drive is the master on a drive-to-drive master/follower link. See parameters <i>60.01 M/F communication port</i> and <i>60.03 M/F mode</i>.)</p> <p>In the master, parameters <i>60.23 M/F status supervision sel 1</i> and <i>60.24 M/F status supervision sel 2</i> specify the followers whose status word is monitored by the master.</p> <p>This parameter selects the followers (out of followers 1...16) whose status words are monitored by the master.</p> <p>If a follower reports a fault (bit 3 of the status word is on), the action specified in <i>60.17 Follower fault action</i> is taken. Bits 0 and 1 of the status word (ready states) are handled as defined by <i>60.18 Follower enable</i>.</p> <p>Using <i>60.27 M/F status supv mode sel 1</i> and <i>60.28 M/F status supv mode sel 2</i>, it is possible to define whether any given follower is only monitored when it is stopped.</p> <p>The status of communication is shown by <i>62.37 M/F communication status 1</i> and <i>62.38 M/F communication status 2</i>.</p>	-															
<table border="1"> <thead> <tr> <th>Bit</th> <th>Name</th> <th>Description</th> </tr> </thead> <tbody> <tr> <td>0</td> <td>Follower 1</td> <td>1 = Status of follower 1 is monitored.</td> </tr> <tr> <td>1</td> <td>Follower 2</td> <td>1 = Status of follower 2 is monitored.</td> </tr> <tr> <td>...</td> <td>...</td> <td>...</td> </tr> <tr> <td>15</td> <td>Follower 16</td> <td>1 = Status of follower 16 is monitored.</td> </tr> </tbody> </table>				Bit	Name	Description	0	Follower 1	1 = Status of follower 1 is monitored.	1	Follower 2	1 = Status of follower 2 is monitored.	15	Follower 16	1 = Status of follower 16 is monitored.
Bit	Name	Description																
0	Follower 1	1 = Status of follower 1 is monitored.																
1	Follower 2	1 = Status of follower 2 is monitored.																
...																
15	Follower 16	1 = Status of follower 16 is monitored.																
0000h...FFFFh		M/F follower status supervision selection (followers 1...16).	1 = 1															

No.	Name/Value	Description	Def/FbEq16															
60.24	<i>M/F status supervision sel 2</i>	Selects the followers (out of followers 17...32) whose status words are monitored by the master. See parameter <i>60.23 M/F status supervision sel 1</i> .	-															
<table border="1"> <thead> <tr> <th>Bit</th> <th>Name</th> <th>Description</th> </tr> </thead> <tbody> <tr> <td>0</td> <td>Follower 17</td> <td>1 = Status of follower 17 is monitored.</td> </tr> <tr> <td>1</td> <td>Follower 18</td> <td>1 = Status of follower 18 is monitored.</td> </tr> <tr> <td>...</td> <td>...</td> <td>...</td> </tr> <tr> <td>15</td> <td>Follower 32</td> <td>1 = Status of follower 32 is monitored.</td> </tr> </tbody> </table>				Bit	Name	Description	0	Follower 17	1 = Status of follower 17 is monitored.	1	Follower 18	1 = Status of follower 18 is monitored.	15	Follower 32	1 = Status of follower 32 is monitored.
Bit	Name	Description																
0	Follower 17	1 = Status of follower 17 is monitored.																
1	Follower 18	1 = Status of follower 18 is monitored.																
...																
15	Follower 32	1 = Status of follower 32 is monitored.																
	0000h...FFFFh	M/F follower status supervision selection (followers 17...32).	1 = 1															
60.27	<i>M/F status supv mode sel 1</i>	In the master, parameters <i>60.27 M/F status supv mode sel 1</i> and <i>60.28 M/F status supv mode sel 2</i> specify the mode of follower status word monitoring. Each follower can individually be set to be monitored continuously, or only when it is in stopped state. This parameter selects the mode of status word monitoring of followers 1...16.	-															
<table border="1"> <thead> <tr> <th>Bit</th> <th>Name</th> <th>Description</th> </tr> </thead> <tbody> <tr> <td>0</td> <td>Follower 1</td> <td>0 = Status of follower 1 is monitored continuously. 1 = Status of follower 1 is monitored only when it is in stopped state.</td> </tr> <tr> <td>1</td> <td>Follower 2</td> <td>0 = Status of follower 2 is monitored continuously. 1 = Status of follower 2 is monitored only when it is in stopped state.</td> </tr> <tr> <td>...</td> <td>...</td> <td>...</td> </tr> <tr> <td>15</td> <td>Follower 16</td> <td>0 = Status of follower 16 is monitored continuously. 1 = Status of follower 16 is monitored only when it is in stopped state.</td> </tr> </tbody> </table>				Bit	Name	Description	0	Follower 1	0 = Status of follower 1 is monitored continuously. 1 = Status of follower 1 is monitored only when it is in stopped state.	1	Follower 2	0 = Status of follower 2 is monitored continuously. 1 = Status of follower 2 is monitored only when it is in stopped state.	15	Follower 16	0 = Status of follower 16 is monitored continuously. 1 = Status of follower 16 is monitored only when it is in stopped state.
Bit	Name	Description																
0	Follower 1	0 = Status of follower 1 is monitored continuously. 1 = Status of follower 1 is monitored only when it is in stopped state.																
1	Follower 2	0 = Status of follower 2 is monitored continuously. 1 = Status of follower 2 is monitored only when it is in stopped state.																
...																
15	Follower 16	0 = Status of follower 16 is monitored continuously. 1 = Status of follower 16 is monitored only when it is in stopped state.																
	0000h...FFFFh	M/F status supervision mode selection 1.	1 = 1															

No.	Name/Value	Description	Def/FbEq16															
60.28	<i>M/F status supv mode sel 2</i>	Selects the mode of status word monitoring of followers 17...32.	-															
		<table border="1"> <thead> <tr> <th>Bit</th> <th>Name</th> <th>Description</th> </tr> </thead> <tbody> <tr> <td>0</td> <td>Follower 17</td> <td>0 = Status of follower 17 is monitored continuously. 1 = Status of follower 17 is monitored only when it is in stopped state.</td> </tr> <tr> <td>1</td> <td>Follower 18</td> <td>0 = Status of follower 18 is monitored continuously. 1 = Status of follower 18 is monitored only when it is in stopped state.</td> </tr> <tr> <td>...</td> <td>...</td> <td>...</td> </tr> <tr> <td>15</td> <td>Follower 32</td> <td>0 = Status of follower 32 is monitored continuously. 1 = Status of follower 32 is monitored only when it is in stopped state.</td> </tr> </tbody> </table>	Bit	Name	Description	0	Follower 17	0 = Status of follower 17 is monitored continuously. 1 = Status of follower 17 is monitored only when it is in stopped state.	1	Follower 18	0 = Status of follower 18 is monitored continuously. 1 = Status of follower 18 is monitored only when it is in stopped state.	15	Follower 32	0 = Status of follower 32 is monitored continuously. 1 = Status of follower 32 is monitored only when it is in stopped state.	
Bit	Name	Description																
0	Follower 17	0 = Status of follower 17 is monitored continuously. 1 = Status of follower 17 is monitored only when it is in stopped state.																
1	Follower 18	0 = Status of follower 18 is monitored continuously. 1 = Status of follower 18 is monitored only when it is in stopped state.																
...																
15	Follower 32	0 = Status of follower 32 is monitored continuously. 1 = Status of follower 32 is monitored only when it is in stopped state.																
	0000h...FFFFh	M/F status supervision mode selection 2.	1 = 1															
60.31	<i>M/F wake up delay</i>	Defines a wake-up delay during which no master/follower communication faults or warnings are generated. This is to allow all drives on the master/follower link to power up. The master cannot be started until the delay elapses or all monitored followers are found to be ready.	60.0 s															
	0.0 ... 180.0 s	Master/follower wake-up delay.	10 = 1 s															
60.32	<i>M/F comm supervision force</i>	Activates master/follower communication monitoring separately for each control location (see section <i>Local control vs. external control</i> on page 26). The parameter is primarily intended for monitoring the communication with master or follower when it is connected to the application program and not selected as a control source by drive parameters.	0000b															
		<table border="1"> <thead> <tr> <th>Bit</th> <th>Name</th> <th>Value</th> </tr> </thead> <tbody> <tr> <td>0</td> <td>Ext 1</td> <td>1 = Communication monitoring active when Ext 1 is being used.</td> </tr> <tr> <td>1</td> <td>Ext 2</td> <td>1 = Communication monitoring active when Ext 2 is being used.</td> </tr> <tr> <td>2</td> <td>Local</td> <td>1 = Communication monitoring active when local control is being used.</td> </tr> <tr> <td>3...15</td> <td>Reserved</td> <td></td> </tr> </tbody> </table>	Bit	Name	Value	0	Ext 1	1 = Communication monitoring active when Ext 1 is being used.	1	Ext 2	1 = Communication monitoring active when Ext 2 is being used.	2	Local	1 = Communication monitoring active when local control is being used.	3...15	Reserved		
Bit	Name	Value																
0	Ext 1	1 = Communication monitoring active when Ext 1 is being used.																
1	Ext 2	1 = Communication monitoring active when Ext 2 is being used.																
2	Local	1 = Communication monitoring active when local control is being used.																
3...15	Reserved																	
	0000b...0111b	Master/follower communication monitoring selection.	1 = 1															

No.	Name/Value	Description	Def/FbEq16
61 D2D and DDCS transmit data		Defines the data sent to the DDCS link. See also parameter group 60 DDCS communication .	
61.01	M/F data 1 selection	Preselects the data to be sent as word 1 onto the master/follower link. See also parameter 61.25 M/F data 1 value , and section Master/follower functionality (page 39).	Follower CW
	None	None.	0
	CW 16bit	Control Word (16 bits)	1
	SW 16bit	Status Word (16 bits)	4
	Act1 16bit	Actual value ACT1 (16 bits) Note: Using this setting to send a reference to the follower is not recommended as the source signal is filtered. Use the “reference” selections instead.	5
	Act2 16bit	Actual value ACT2 (16 bits) Note: Using this setting to send a reference to the follower is not recommended as the source signal is filtered. Use the “reference” selections instead.	6
	Follower CW	A word consisting of bits 0...11 of 06.01 Main control word and the bits selected by parameters 06.45...06.48 . Note: Bit 3 of the follower control word is kept on as long as the master is modulating, and when it switches to 0, the follower coasts to a stop.	27
	Used speed reference	24.01 Used speed reference (page 217).	6145
	Torque reference act 5	26.75 Torque reference act 5 (page 242).	6731
	Torque reference used	26.02 Torque reference used (page 234).	6658
	Other	Source selection (see Terms and abbreviations on page 90).	-
61.02	M/F data 2 selection	Preselects the data to be sent as word 2 onto the master/follower link. See also parameter 61.26 M/F data 2 value . For the selections, see parameter 61.01 M/F data 1 selection .	Used speed reference
61.03	M/F data 3 selection	Preselects the data to be sent as word 3 onto the master/follower link. See also parameter 61.27 M/F data 3 value . For the selections, see parameter 61.01 M/F data 1 selection .	Torque reference act 5

No.	Name/Value	Description	Def/FbEq16
61.25	<i>M/F data 1 value</i>	Displays the data to be sent onto the master/follower link as word 1 as an integer. If no data has been preselected by <i>61.01 M/F data 1 selection</i> , the value to be sent can be written directly into this parameter.	0
	0...65535	Data to be sent as word 1 in master/follower communication.	
61.26	<i>M/F data 2 value</i>	Displays the data to be sent onto the master/follower link as word 2 as an integer. If no data has been preselected by <i>61.02 M/F data 2 selection</i> , the value to be sent can be written directly into this parameter.	0
	0...65535	Data to be sent as word 2 in master/follower communication.	
61.27	<i>M/F data 3 value</i>	Displays the data to be sent onto the master/follower link as word 3 as an integer. If no data has been preselected by <i>61.03 M/F data 3 selection</i> , the value to be sent can be written directly into this parameter.	0
	0...65535	Data to be sent as word 3 in master/follower communication.	
61.45	<i>Data set 2 data 1 selection</i>	Parameters <i>61.45...61.50</i> preselect data to be sent in data sets 2 and 4 to the external controller. Parameters <i>61.95...61.100</i> display the data to be sent to the external controller. If no data has been preselected, the value to be sent can be written directly into these parameters. For example, this parameter preselects the data for word 1 of data set 2. Parameter <i>61.95 Data set 2 data 1 value</i> displays the selected data in integer format. If no data is preselected, the value to be sent can be written directly into parameter <i>61.95</i> .	<i>None</i>
	None	None.	0
	CW 16bit	Control Word (16 bits)	1
	SW 16bit	Status Word (16 bits)	4
	Act1 16bit	Actual value ACT1 (16 bits)	5
	Act2 16bit	Actual value ACT2 (16 bits)	6
	<i>Other</i>	Source selection (see <i>Terms and abbreviations</i> on page 90).	-
61.46	<i>Data set 2 data 2 selection</i>	Preselects the data to be sent as word 2 of data set 2 to the external controller. See also parameter <i>61.96 Data set 2 data 2 value</i> . For the selections, see parameter <i>61.45 Data set 2 data 1 selection</i> .	<i>None</i>

No.	Name/Value	Description	Def/FbEq16
61.47	Data set 2 data 3 selection	See parameter 61.45 Data set 2 data 1 selection .	None
...
61.50	Data set 4 data 3 selection	See parameter 61.45 Data set 2 data 1 selection .	None
61.51	Data set 11 data 1 selection	<p>Parameters 61.51...61.74 preselect data to be sent in data sets 11, 13, 15, 17, 19, 21, 23 and 25 to the external controller.</p> <p>Parameters 61.101...61.124 display the data to be sent to the external controller. If no data has been preselected, the value to be sent can be written directly into these parameters.</p> <p>For example, this parameter preselects the data for word 1 of data set 11. Parameter 61.101 Data set 11 data 1 value displays the selected data in integer format. If no data is preselected, the value to be sent can be written directly into parameter 61.101.</p>	None
	None	None.	0
	CW 16bit	Control Word (16 bits)	1
	SW 16bit	Status Word (16 bits)	4
	Act1 16bit	Actual value ACT1 (16 bits)	5
	Act2 16bit	Actual value ACT2 (16 bits)	6
	<i>Other</i>	Source selection (see Terms and abbreviations on page 90).	-
61.52	Data set 11 data 2 selection	<p>Preselects the data to be sent as word 2 of data set 11 to the external controller.</p> <p>See also parameter 61.102 Data set 11 data 2 value.</p> <p>For the selections, see parameter 61.51 Data set 11 data 1 selection.</p>	None
61.53	Data set 11 data 3 selection	<p>Preselects the data to be sent as word 3 of data set 11 to the external controller.</p> <p>See also parameter 61.103 Data set 11 data 3 value.</p> <p>For the selections, see parameter 61.51 Data set 11 data 1 selection.</p>	None
61.54	Data set 13 data 1 selection	See parameter 61.51 Data set 11 data 1 selection .	None
...
61.74	Data set 25 data 3 selection	See parameter 61.51 Data set 11 data 1 selection .	None

No.	Name/Value	Description	Def/FbEq16
61.95	<i>Data set 2 data 1 value</i>	Displays (in integer format) the data to be sent to the external controller as word 1 of data set 2. If no data has been preselected by 61.45 Data set 2 data 1 selection , the value to be sent can be written directly into this parameter.	0
	0...65535	Data to be sent as word 1 of data set 2.	
61.96	<i>Data set 2 data 2 value</i>	Displays (in integer format) the data to be sent to the external controller as word 2 of data set 2. If no data has been preselected by 61.46 Data set 2 data 2 selection , the value to be sent can be written directly into this parameter.	0
	0...65535	Data to be sent as word 2 of data set 2.	
61.97	<i>Data set 2 data 3 value</i>	Displays (in integer format) the data to be sent to the external controller as word 3 of data set 2. If no data has been preselected by 61.47 Data set 2 data 3 selection , the value to be sent can be written directly into this parameter.	0
	0...65535	Data to be sent as word 3 of data set 2.	
...
61.100	<i>Data set 4 data 3 value</i>	Displays (in integer format) the data to be sent to the external controller as word 3 of data set 4. If no data has been selected by 61.50 Data set 4 data 3 selection , the value to be sent can be written directly into this parameter.	0
	0...65535	Data to be sent as word 3 of data set 4.	
61.101	<i>Data set 11 data 1 value</i>	Displays (in integer format) the data to be sent to the external controller as word 1 of data set 11. If no data has been preselected by 61.51 Data set 11 data 1 selection , the value to be sent can be written directly into this parameter.	0
	0...65535	Data to be sent as word 1 of data set 11.	
61.102	<i>Data set 11 data 2 value</i>	Displays (in integer format) the data to be sent to the external controller as word 2 of data set 11. If no data has been preselected by 61.52 Data set 11 data 2 selection , the value to be sent can be written directly into this parameter.	0
	0...65535	Data to be sent as word 2 of data set 11.	
61.103	<i>Data set 11 data 3 value</i>	Displays (in integer format) the data to be sent to the external controller as word 3 of data set 11. If no data has been selected by 61.53 Data set 11 data 3 selection , the value to be sent can be written directly into this parameter.	0
	0...65535	Data to be sent as word 3 of data set 11.	

370 Parameters

No.	Name/Value	Description	Def/FbEq16
61.104	Data set 13 data 1 value	Displays (in integer format) the data to be sent to the external controller as word 1 of data set 13. If no data has been selected by 61.54 Data set 13 data 1 selection , the value to be sent can be written directly into this parameter.	0
	0...65535	Data to be sent as word 1 of data set 13.	
...
61.124	Data set 25 data 3 value	Displays (in integer format) the data to be sent to the external controller as word 3 of data set 25. If no data has been selected by 61.74 Data set 25 data 3 selection , the value to be sent can be written directly into this parameter.	0
	0...65535	Data to be sent as word 3 of data set 25.	
62 D2D and DDCS receive data		Mapping of data received through the DDCS link. See also parameter group 60 DDCS communication .	
62.01	M/F data 1 selection	(Follower only) Defines a target for the data received as word 1 from the master through the master/follower link. See also parameter 62.25 MF data 1 value .	<i>None</i>
	None	None.	0
	CW 16bit	Control Word (16 bits)	1
	Ref1 16bit	Reference REF1 (16 bits)	2
	Ref2 16bit	Reference REF2 (16 bits)	3
	<i>Other</i>	Source selection (see Terms and abbreviations on page 90).	-
62.02	M/F data 2 selection	(Follower only) Defines a target for the data received as word 2 from the master through the master/follower link. See also parameter 62.26 MF data 2 value . For the selections, see parameter 62.01 M/F data 1 selection .	<i>None</i>
62.03	M/F data 3 selection	(Follower only) Defines a target for the data received as word 3 from the master through the master/follower link. See also parameter 62.27 MF data 3 value . For the selections, see parameter 62.01 M/F data 1 selection .	<i>None</i>

No.	Name/Value	Description	Def/FbEq16
62.04	<i>Follower node 2 data 1 sel</i>	Defines a target for the data received as word 1 from the first follower (ie. the follower with node address 2) through the master/follower link. See also parameter 62.28 Follower node 2 data 1 value .	<i>Follower SW</i>
	None	None.	0
	Follower SW	Status word of the follower. See also parameter 60.18 Follower enable .	26
	<i>Other</i>	Source selection (see Terms and abbreviations on page 90).	-
62.05	<i>Follower node 2 data 2 sel</i>	Defines a target for the data received as word 2 from the first follower (ie. the follower with node address 2) through the master/follower link. See also parameter 62.29 Follower node 2 data 2 value . For the selections, see parameter 62.04 Follower node 2 data 1 sel .	<i>None</i>
62.06	<i>Follower node 2 data 3 sel</i>	Defines a target for the data received as word 3 from the first follower (ie. the follower with node address 2) through the master/follower link. See also parameter 62.30 Follower node 2 data 3 value . For the selections, see parameter 62.04 Follower node 2 data 1 sel .	<i>None</i>
62.07	<i>Follower node 3 data 1 sel</i>	Defines a target for the data received as word 1 from the second follower (ie. the follower with node address 3) through the master/follower link. See also parameter 62.31 Follower node 3 data 1 value . For the selections, see parameter 62.04 Follower node 2 data 1 sel .	<i>Follower SW</i>
62.08	<i>Follower node 3 data 2 sel</i>	Defines a target for the data received as word 2 from the second follower (ie. the follower with node address 3) through the master/follower link. See also parameter 62.32 Follower node 3 data 2 value . For the selections, see parameter 62.04 Follower node 2 data 1 sel .	<i>None</i>

No.	Name/Value	Description	Def/FbEq16
62.09	<i>Follower node 3 data 3 sel</i>	<p>Defines a target for the data received as word 3 from the second follower (ie. the follower with node address 3) through the master/follower link.</p> <p>See also parameter 62.33 Follower node 3 data 3 value.</p> <p>For the selections, see parameter 62.04 Follower node 2 data 1 sel.</p>	None
62.10	<i>Follower node 4 data 1 sel</i>	<p>Defines a target for the data received as word 1 from the third follower (ie. the follower with node address 4) through the master/follower link.</p> <p>See also parameter 62.34 Follower node 4 data 1 value.</p> <p>For the selections, see parameter 62.04 Follower node 2 data 1 sel.</p>	Follower SW
62.11	<i>Follower node 4 data 2 sel</i>	<p>Defines a target for the data received as word 2 from the third follower (ie. the follower with node address 4) through the master/follower link.</p> <p>See also parameter 62.35 Follower node 4 data 2 value.</p> <p>For the selections, see parameter 62.04 Follower node 2 data 1 sel.</p>	None
62.12	<i>Follower node 4 data 3 sel</i>	<p>Defines a target for the data received as word 3 from the third follower (ie. the follower with node address 4) through the master/follower link.</p> <p>See also parameter 62.36 Follower node 4 data 3 value.</p> <p>For the selections, see parameter 62.04 Follower node 2 data 1 sel.</p>	None
62.25	<i>MF data 1 value</i>	<p>(Follower only) Displays, in integer format, the data received from the master as word 1.</p> <p>Parameter 62.01 M/F data 1 selection can be used to select a target for the received data. This parameter can also be used as a signal source by other parameters.</p>	0
	0...65535	Data received as word 1 in master/follower communication.	
62.26	<i>MF data 2 value</i>	<p>(Follower only) Displays, in integer format, the data received from the master as word 2.</p> <p>Parameter 62.02 M/F data 2 selection can be used to select a target for the received data. This parameter can also be used as a signal source by other parameters.</p>	0
	0...65535	Data received as word 2 in master/follower communication.	

No.	Name/Value	Description	Def/FbEq16
62.27	<i>MF data 3 value</i>	(Follower only) Displays, in integer format, the data received from the master as word 3. Parameter 62.03 M/F data 3 selection can be used to select a target for the received data. This parameter can also be used as a signal source by other parameters.	0
0..65535		Data received as word 3 in master/follower communication.	
62.28	<i>Follower node 2 data 1 value</i>	Displays, in integer format, the data received from the first follower (ie. follower with node address 2) as word 1. Parameter 62.04 Follower node 2 data 1 sel can be used to select a target for the received data. This parameter can also be used as a signal source by other parameters.	0
0..65535		Data received as word 1 from follower with node address 2.	
62.29	<i>Follower node 2 data 2 value</i>	Displays, in integer format, the data received from the first follower (ie. follower with node address 2) as word 2. Parameter 62.05 Follower node 2 data 2 sel can be used to select a target for the received data. This parameter can also be used as a signal source by other parameters.	0
0..65535		Data received as word 2 from follower with node address 2.	
62.30	<i>Follower node 2 data 3 value</i>	Displays, in integer format, the data received from the first follower (ie. follower with node address 2) as word 3. Parameter 62.06 Follower node 2 data 3 sel can be used to select a target for the received data. This parameter can also be used as a signal source by other parameters.	0
0..65535		Data received as word 3 from follower with node address 2.	
62.31	<i>Follower node 3 data 1 value</i>	Displays, in integer format, the data received from the second follower (ie. follower with node address 3) as word 1. Parameter 62.07 Follower node 3 data 1 sel can be used to select a target for the received data. This parameter can also be used as a signal source by other parameters.	0
0..65535		Data received as word 1 from follower with node address 3.	

No.	Name/Value	Description	Def/FbEq16
62.32	<i>Follower node 3 data 2 value</i>	Displays, in integer format, the data received from the second follower (ie. follower with node address 3) as word 2. Parameter <i>62.08 Follower node 3 data 2 sel</i> can be used to select a target for the received data. This parameter can also be used as a signal source by other parameters.	0
0...65535		Data received as word 2 from follower with node address 3.	
62.33	<i>Follower node 3 data 3 value</i>	Displays, in integer format, the data received from the second follower (ie. follower with node address 3) as word 3. Parameter <i>62.09 Follower node 3 data 3 sel</i> can be used to select a target for the received data. This parameter can also be used as a signal source by other parameters.	0
0...65535		Data received as word 3 from follower with node address 3.	
62.34	<i>Follower node 4 data 1 value</i>	Displays, in integer format, the data received from the third follower (ie. follower with node address 4) as word 1. Parameter <i>62.10 Follower node 4 data 1 sel</i> can be used to select a target for the received data. This parameter can also be used as a signal source by other parameters.	0
0...65535		Data received as word 1 from follower with node address 4.	
62.35	<i>Follower node 4 data 2 value</i>	Displays, in integer format, the data received from the third follower (ie. follower with node address 4) as word 2. Parameter <i>62.11 Follower node 4 data 2 sel</i> can be used to select a target for the received data. This parameter can also be used as a signal source by other parameters.	0
0...65535		Data received as word 2 from follower with node address 4.	
62.36	<i>Follower node 4 data 3 value</i>	Displays, in integer format, the data received from the third follower (ie. follower with node address 4) as word 3. Parameter <i>62.12 Follower node 4 data 3 sel</i> can be used to select a target for the received data. This parameter can also be used as a signal source by other parameters.	0
0...65535		Data received as word 3 from follower with node address 4.	

No.	Name/Value	Description	Def/FbEq16															
62.37	<i>M/F communication status 1</i>	In the master, displays the status of the communication with followers specified by parameter <i>60.19 M/F comm supervision sel 1</i> . In a follower, bit 0 indicates the status of the communication with the master.	-															
<table border="1"> <thead> <tr> <th>Bit</th> <th>Name</th> <th>Description</th> </tr> </thead> <tbody> <tr> <td>0</td> <td>Follower 1</td> <td>1 (in the master) = Communication with follower 1 OK. 1 (in a follower) = Communication with master OK.</td> </tr> <tr> <td>1</td> <td>Follower 2</td> <td>1 = Communication with follower 2 OK.</td> </tr> <tr> <td>...</td> <td>...</td> <td>...</td> </tr> <tr> <td>15</td> <td>Follower 16</td> <td>1 = Communication with follower 16 OK.</td> </tr> </tbody> </table>				Bit	Name	Description	0	Follower 1	1 (in the master) = Communication with follower 1 OK. 1 (in a follower) = Communication with master OK.	1	Follower 2	1 = Communication with follower 2 OK.	15	Follower 16	1 = Communication with follower 16 OK.
Bit	Name	Description																
0	Follower 1	1 (in the master) = Communication with follower 1 OK. 1 (in a follower) = Communication with master OK.																
1	Follower 2	1 = Communication with follower 2 OK.																
...																
15	Follower 16	1 = Communication with follower 16 OK.																
0000h...FFFFh		M/F communication status (followers 1...16).	1 = 1															
62.38	<i>M/F communication status 2</i>	In the master, displays the status of the communication with followers specified by parameter <i>60.20 M/F comm supervision sel 2</i> .	-															
<table border="1"> <thead> <tr> <th>Bit</th> <th>Name</th> <th>Description</th> </tr> </thead> <tbody> <tr> <td>0</td> <td>Follower 17</td> <td>1 = Communication with follower 17 OK.</td> </tr> <tr> <td>1</td> <td>Follower 18</td> <td>1 = Communication with follower 18 OK.</td> </tr> <tr> <td>...</td> <td>...</td> <td>...</td> </tr> <tr> <td>15</td> <td>Follower 32</td> <td>1 = Communication with follower 32 OK.</td> </tr> </tbody> </table>				Bit	Name	Description	0	Follower 17	1 = Communication with follower 17 OK.	1	Follower 18	1 = Communication with follower 18 OK.	15	Follower 32	1 = Communication with follower 32 OK.
Bit	Name	Description																
0	Follower 17	1 = Communication with follower 17 OK.																
1	Follower 18	1 = Communication with follower 18 OK.																
...																
15	Follower 32	1 = Communication with follower 32 OK.																
0000h...FFFFh		M/F communication status (followers 17...32).	1 = 1															
62.41	<i>M/F follower ready status 1</i>	In the master, displays the ready status of the communication with followers specified by parameter <i>60.23 M/F status supervision sel 1</i> .	-															
<table border="1"> <thead> <tr> <th>Bit</th> <th>Name</th> <th>Description</th> </tr> </thead> <tbody> <tr> <td>0</td> <td>Follower 1</td> <td>1 = Follower 1 ready.</td> </tr> <tr> <td>1</td> <td>Follower 2</td> <td>1 = Follower 2 ready.</td> </tr> <tr> <td>...</td> <td>...</td> <td>...</td> </tr> <tr> <td>15</td> <td>Follower 16</td> <td>1 = Follower 16 ready.</td> </tr> </tbody> </table>				Bit	Name	Description	0	Follower 1	1 = Follower 1 ready.	1	Follower 2	1 = Follower 2 ready.	15	Follower 16	1 = Follower 16 ready.
Bit	Name	Description																
0	Follower 1	1 = Follower 1 ready.																
1	Follower 2	1 = Follower 2 ready.																
...																
15	Follower 16	1 = Follower 16 ready.																
0000h...FFFFh		Follower 1...16 ready status.	1 = 1															

No.	Name/Value	Description	Def/FbEq16															
62.42	<i>M/F follower ready status 2</i>	In the master, displays the ready status of the communication with followers specified by parameter <i>60.24 M/F status supervision sel 2</i> .	-															
<table border="1"> <thead> <tr> <th>Bit</th> <th>Name</th> <th>Description</th> </tr> </thead> <tbody> <tr> <td>0</td> <td>Follower 17</td> <td>1 = Follower 17 ready.</td> </tr> <tr> <td>1</td> <td>Follower 18</td> <td>1 = Follower 18 ready.</td> </tr> <tr> <td>...</td> <td>...</td> <td>...</td> </tr> <tr> <td>15</td> <td>Follower 32</td> <td>1 = Follower 32 ready.</td> </tr> </tbody> </table>				Bit	Name	Description	0	Follower 17	1 = Follower 17 ready.	1	Follower 18	1 = Follower 18 ready.	15	Follower 32	1 = Follower 32 ready.
Bit	Name	Description																
0	Follower 17	1 = Follower 17 ready.																
1	Follower 18	1 = Follower 18 ready.																
...																
15	Follower 32	1 = Follower 32 ready.																
	0000h...FFFFh	Follower 17...32 ready status.	1 = 1															
62.45	<i>Data set 1 data 1 selection</i>	Parameters <i>62.45...62.50</i> define a target for the data received in data sets 1 and 3 from the external controller. Parameters <i>62.95...62.100</i> display the data received from the external controller in integer format, and can be used as sources by other parameters. For example, this parameter selects a target for word 1 of data set 1. Parameter <i>62.95 Data set 1 data 1 value</i> displays the received data in integer format, and can also be used as a source by other parameters.	<i>None</i>															
	None	None.	0															
	CW 16bit	Control Word (16 bits)	1															
	Ref1 16bit	Reference REF1 (16 bits)	2															
	Ref2 16bit	Reference REF2 (16 bits)	3															
	<i>Other</i>	Source selection (see <i>Terms and abbreviations</i> on page 90).	-															
62.46	<i>Data set 1 data 2 selection</i>	Defines a target for the data received as word 2 of data set 1. See also parameter <i>62.96 Data set 1 data 2 value</i> . For the selections, see parameter <i>62.45 Data set 1 data 1 selection</i> .	<i>None</i>															
62.47	<i>Data set 1 data 3 selection</i>	See parameter <i>62.45 Data set 1 data 1 selection</i> .	<i>None</i>															
...															
62.50	<i>Data set 3 data 3 selection</i>	See parameter <i>62.45 Data set 1 data 1 selection</i> .	<i>None</i>															

No.	Name/Value	Description	Def/FbEq16
62.51	<i>Data set 10 data 1 selection</i>	Parameters 62.51 ... 62.74 define a target for the data received in data sets 10, 12, 14, 16, 18, 20, 22 and 24 from the external controller. Parameters 62.101 ... 62.124 display the data received from the external controller in integer format, and can be used as sources by other parameters. For example, this parameter selects a target for word 1 of data set 10. Parameter 62.101 Data set 10 data 1 value displays the received data in integer format, and can also be used as a source by other parameters.	None
	None	None.	0
	CW 16bit	Control Word (16 bits)	1
	Ref1 16bit	Reference REF1 (16 bits)	2
	Ref2 16bit	Reference REF2 (16 bits)	3
	<i>Other</i>	Source selection (see Terms and abbreviations on page 90).	-
62.52	<i>Data set 10 data 2 selection</i>	Defines a target for the data received as word 2 of data set 10. See also parameter 62.102 Data set 10 data 2 value . For the selections, see parameter 62.51 Data set 10 data 1 selection .	None
62.53	<i>Data set 10 data 3 selection</i>	Defines a target for the data received as word 3 of data set 10. See also parameter 62.103 Data set 10 data 3 value . For the selections, see parameter 62.51 Data set 10 data 1 selection .	None
62.54	<i>Data set 12 data 1 selection</i>	See parameter 62.51 Data set 10 data 1 selection .	None
...
62.74	<i>Data set 24 data 3 selection</i>	See parameter 62.51 Data set 10 data 1 selection .	None
62.95	<i>Data set 1 data 1 value</i>	Displays (in integer format) the data received from the external controller as word 1 of data set 1. A target for this data can be selected by parameter 62.45 Data set 1 data 1 selection . The value can also be used as a source by another parameter.	0
	0...65535	Data received as word 1 of data set 1.	

No.	Name/Value	Description	Def/FbEq16
62.96	<i>Data set 1 data 2 value</i>	Displays (in integer format) the data received from the external controller as word 2 of data set 1. A target for this data can be selected by parameter 62.46 Data set 1 data 2 selection . The value can also be used as a source by another parameter.	0
	0...65535	Data received as word 2 of data set 1.	
62.97	<i>Data set 1 data 3 value</i>	Displays (in integer format) the data received from the external controller as word 3 of data set 1. A target for this data can be selected by parameter 62.47 Data set 1 data 3 selection . The value can also be used as a source by another parameter.	0
	0...65535	Data received as word 3 of data set 1.	
...
62.100	<i>Data set 3 data 3 value</i>	Displays (in integer format) the data received from the external controller as word 3 of data set 3. A target for this data can be selected by parameter 62.50 Data set 3 data 3 selection . The value can also be used as a source by another parameter.	0
	0...65535	Data received as word 3 of data set 3.	
62.101	<i>Data set 10 data 1 value</i>	Displays (in integer format) the data received from the external controller as word 1 of data set 10. A target for this data can be selected by parameter 62.51 Data set 10 data 1 selection . The value can also be used as a source by another parameter.	0
	0...65535	Data received as word 1 of data set 10.	
62.102	<i>Data set 10 data 2 value</i>	Displays (in integer format) the data received from the external controller as word 2 of data set 10. A target for this data can be selected by parameter 62.52 Data set 10 data 2 selection . The value can also be used as a source by another parameter.	0
	0...65535	Data received as word 2 of data set 10.	
62.103	<i>Data set 10 data 3 value</i>	Displays (in integer format) the data received from the external controller as word 3 of data set 10. A target for this data can be selected by parameter 62.53 Data set 10 data 3 selection . The value can also be used as a source by another parameter.	0
	0...65535	Data received as word 3 of data set 10.	

No.	Name/Value	Description	Def/FbEq16
62.104	<i>Data set 12 data 1 value</i>	Displays (in integer format) the data received from the external controller as word 1 of data set 12. A target for this data can be selected by parameter 62.54 Data set 12 data 1 selection . The value can also be used as a source by another parameter.	0
	0...65535	Data received as word 1 of data set 12.	
...
62.124	<i>Data set 24 data 3 value</i>	Displays (in integer format) the data received from the external controller as word 3 of data set 24. A target for this data can be selected by parameter 62.74 Data set 24 data 3 selection . The value can also be used as a source by another parameter.	0
	0...65535	Data received as word 3 of data set 24.	
90 Feedback selection		Motor and load feedback configuration. See also sections Encoder support (page 52) and Position counter (page 54), and the diagram on page 569.	
90.01	<i>Motor speed for control</i>	Displays the estimated or measured motor speed that is used for motor control, ie. final motor speed feedback selected by parameter 90.41 Motor feedback selection and filtered by 90.42 Motor speed filter time . In case measured feedback is selected, it is also scaled by the motor gear function (90.43 Motor gear numerator and 90.44 Motor gear denominator). This parameter is read-only.	-
	-32768.00 ... 32767.00 rpm	Motor speed used for control.	See par. 46.01
90.02	<i>Motor position</i>	Displays the motor position (within one revolution) received from the source selected by parameter 90.41 Motor feedback selection . In case measured feedback is selected, it is also scaled by the motor gear function (90.43 Motor gear numerator and 90.44 Motor gear denominator). This parameter is read-only.	-
	0.00000000 ... 1.00000000 rev	Motor position.	32767 = 1 rev

No.	Name/Value	Description	Def/FbEq16
90.03	<i>Load speed</i>	<p>Displays the estimated or measured load speed that is used for motor control, ie. final load speed feedback selected by parameter 90.51 Load feedback selection and filtered by parameter 90.52 Load speed filter time.</p> <p>In case measured feedback is selected, it is also scaled by the load gear function (90.53 Load gear numerator and 90.54 Load gear denominator).</p> <p>In case motor feedback or estimated feedback is used, it is inversely scaled by 90.61 Gear numerator and 90.62 Gear denominator (ie. 90.62 divided by 90.61).</p> <p>This parameter is read-only.</p>	-
	-32768.00 ... 32767.00 rpm	Load speed.	See par. 46.01
90.04	<i>Load position</i>	<p>Displays the load position received from the source selected by parameter 90.51 Load feedback selection. The value is multiplied as specified by parameter 90.57 Load position resolution.</p> <p>In case measured feedback is selected, it is also scaled by the load gear function (90.53 Load gear numerator and 90.54 Load gear denominator).</p> <p>In case motor feedback or estimated feedback is used, it is inversely scaled by 90.61 Gear numerator and 90.62 Gear denominator (ie. 90.62 divided by 90.61).</p> <p>An offset can be defined by 90.56 Load position offset.</p> <p>This parameter is read-only.</p>	-
	-2147483648 ... 2147483647	Load position.	-
90.05	<i>Load position scaled</i>	<p>Displays the scaled load position in decimal format. The position is relative to the initial position set by parameters 90.65 and 90.66.</p> <p>The number of decimal places is defined by parameter 90.38 Pos counter decimals.</p> <p>Note: This is a floating point parameter, and the accuracy is compromised near the ends of the range. Consider using parameter 90.07 Load position scaled int instead of this parameter.</p> <p>This parameter is read-only.</p>	-
	-2147483.648 ... 2147483.647	Scaled load position in decimal format.	-

No.	Name/Value	Description	Def/FbEq16
90.06	<i>Motor position scaled</i>	<p>Displays the calculated motor position.</p> <p>The axis mode (linear or rollover) and resolution are defined by parameters 90.48 Motor position axis mode and 90.49 Motor position resolution respectively.</p> <p>Note: The position value can be sent on a fast time level to the fieldbus controller by selecting <i>Position</i> in either 50.07 FBA A actual 1 type, 50.08 FBA A actual 2 type, 50.37 FBA B actual 1 type or 50.38 FBA B actual 2 type.</p> <p>This parameter is read-only.</p>	-
	-2147483.648 ... 2147483.647	Motor position.	-
90.07	<i>Load position scaled int</i>	<p>Displays the output of the position counter function as an integer, enabling backwards compatibility with ACS 600 and ACS800 drives. The position is relative to the initial position set by parameters 90.58 and 90.59. See section Position counter (page 54), and the block diagram on page 570.</p> <p>This parameter is read-only.</p>	-
	-2147483648 ... 2147483647	Scaled load position in integer format.	-
90.10	<i>Encoder 1 speed</i>	<p>Displays encoder 1 speed in rpm.</p> <p>This parameter is read-only.</p>	-
	-32768.00 ... 32767.00 rpm	Encoder 1 speed.	See par. 46.01
90.11	<i>Encoder 1 position</i>	<p>Displays the actual position of encoder 1 within one revolution.</p> <p>This parameter is read-only.</p>	-
	0.00000000 ... 1.00000000 rev	Encoder 1 position within one revolution.	32767 = 1 rev
90.12	<i>Encoder 1 multiturn revolutions</i>	<p>Displays the revolutions of (multiturn) encoder 1 within its value range (see parameter 92.14 Revolution data width).</p> <p>This parameter is read-only.</p>	-
	0...16777215	Encoder 1 revolutions.	-

No.	Name/Value	Description	Def/FbEq16
90.13	<i>Encoder 1 revolution extension</i>	Displays the revolution count extension for encoder 1. With a single-turn encoder, the counter is incremented when encoder position (parameter 90.11) wraps around in the positive direction, and decremented in the negative direction. With a multiturn encoder, the counter is incremented when the revolutions count (parameter 90.12) exceeds the value range in the positive direction, and decremented in the negative direction. This parameter is read-only.	-
	-2147483648 ... 2147483647	Encoder 1 revolution count extension.	-
90.14	<i>Encoder 1 position raw</i>	Displays the raw measurement data of encoder 1 position (within one revolution) as a 24-bit unsigned integer received from the encoder interface. This parameter is read-only.	-
	0...16777215	Raw encoder 1 position within one revolution.	-
90.15	<i>Encoder 1 revolutions raw</i>	Displays the revolutions of (multiturn) encoder 1 within its value range (see parameter 92.14 Revolution data width) as a raw measurement. This parameter is read-only.	-
	0...16777215	Raw encoder 1 revolution count.	-
90.20	<i>Encoder 2 speed</i>	Displays encoder 2 speed in rpm. This parameter is read-only.	-
	-32768.00 ... 32767.00 rpm	Encoder 2 speed.	See par. 46.01
90.21	<i>Encoder 2 position</i>	Displays the actual position of encoder 2 within one revolution. This parameter is read-only.	-
	0.00000000 ... 1.00000000 rev	Encoder 2 position within one revolution.	-
90.22	<i>Encoder 2 multiturn revolutions</i>	Displays the revolutions of (multiturn) encoder 2 within its value range (see parameter 93.14 Revolution data width). This parameter is read-only.	-
	0...16777215	Encoder 2 revolutions.	-

No.	Name/Value	Description	Def/FbEq16
90.23	<i>Encoder 2 revolution extension</i>	<p>Displays the revolution count extension for encoder 2.</p> <p>With a single-turn encoder, the counter is incremented when encoder position (parameter 90.21) wraps around in the positive direction, and decremented in the negative direction.</p> <p>With a multiturn encoder, the counter is incremented when the revolutions count (parameter 90.22) exceeds the value range in the positive direction, and decremented in the negative direction.</p> <p>This parameter is read-only.</p>	-
	-2147483648 ... 2147483647	Encoder 2 revolution count extension.	-
90.24	<i>Encoder 2 position raw</i>	<p>Displays the raw measurement data of of encoder 2 position (within one revolution) as a 24-bit unsigned integer received from the encoder interface.</p> <p>This parameter is read-only.</p>	-
	0...16777215	Raw encoder 2 position within one revolution.	-
90.25	<i>Encoder 2 revolutions raw</i>	<p>Displays the revolutions of (multiturn) encoder 2 within its value range (see parameter 93.14 Revolution data width) as a raw measurement.</p> <p>This parameter is read-only.</p>	-
	0...16777215	Raw encoder 2 revolution count.	-
90.26	<i>Motor revolution extension</i>	<p>Displays the motor revolution count extension.</p> <p>The counter is incremented when the position selected by 90.41 Motor feedback selection wraps around in the positive direction, and decremented in the negative direction.</p> <p>This parameter is read-only.</p>	-
	-2147483648 ... 2147483647	Motor revolution count extension.	-
90.27	<i>Load revolution extension</i>	<p>Displays the load revolution count extension.</p> <p>The counter is incremented when the position selected by 90.51 Load feedback selection wraps around in the positive direction, and decremented in the negative direction.</p> <p>This parameter is read-only.</p>	-
	-2147483648 ... 2147483647	Load revolution count extension.	-

No.	Name/Value	Description	Def/FbEq16																										
90.35	<i>Pos counter status</i>	Status information related to the position counter function. See section <i>Position counter</i> (page 54). This parameter is read-only.	-																										
	<table border="1"> <thead> <tr> <th>Bit</th> <th>Name</th> <th>Value</th> </tr> </thead> <tbody> <tr> <td>0</td> <td>Encoder 1 feedback</td> <td>1 = Encoder 1 selected as load feedback source</td> </tr> <tr> <td>1</td> <td>Encoder 2 feedback</td> <td>1 = Encoder 2 selected as load feedback source</td> </tr> <tr> <td>2</td> <td>Internal position feedback</td> <td>1 = Internal load position estimate selected as load feedback source</td> </tr> <tr> <td>3</td> <td>Motor feedback</td> <td>1 = Motor feedback selected as load feedback source</td> </tr> <tr> <td>4</td> <td>Pos counter init ready</td> <td>0 = Position counter not initialized, or encoder feedback was lost. Fresh counter initialization recommended. 1 = Position counter successfully initialized</td> </tr> <tr> <td>5</td> <td>Position counter re-init disabled</td> <td>1 = Position counter initialization is being prevented by par. 90.68</td> </tr> <tr> <td>6</td> <td>Position data inaccurate</td> <td>1 = Encoder feedback intermittent or lost. (If the drive is running, estimated position is used whenever encoder feedback is unavailable. If the drive is in stopped state, position counting will continue based on encoder data after the connection is restored.)</td> </tr> <tr> <td>7...15</td> <td>Reserved</td> <td></td> </tr> </tbody> </table>	Bit	Name	Value	0	Encoder 1 feedback	1 = Encoder 1 selected as load feedback source	1	Encoder 2 feedback	1 = Encoder 2 selected as load feedback source	2	Internal position feedback	1 = Internal load position estimate selected as load feedback source	3	Motor feedback	1 = Motor feedback selected as load feedback source	4	Pos counter init ready	0 = Position counter not initialized, or encoder feedback was lost. Fresh counter initialization recommended. 1 = Position counter successfully initialized	5	Position counter re-init disabled	1 = Position counter initialization is being prevented by par. 90.68	6	Position data inaccurate	1 = Encoder feedback intermittent or lost. (If the drive is running, estimated position is used whenever encoder feedback is unavailable. If the drive is in stopped state, position counting will continue based on encoder data after the connection is restored.)	7...15	Reserved		
Bit	Name	Value																											
0	Encoder 1 feedback	1 = Encoder 1 selected as load feedback source																											
1	Encoder 2 feedback	1 = Encoder 2 selected as load feedback source																											
2	Internal position feedback	1 = Internal load position estimate selected as load feedback source																											
3	Motor feedback	1 = Motor feedback selected as load feedback source																											
4	Pos counter init ready	0 = Position counter not initialized, or encoder feedback was lost. Fresh counter initialization recommended. 1 = Position counter successfully initialized																											
5	Position counter re-init disabled	1 = Position counter initialization is being prevented by par. 90.68																											
6	Position data inaccurate	1 = Encoder feedback intermittent or lost. (If the drive is running, estimated position is used whenever encoder feedback is unavailable. If the drive is in stopped state, position counting will continue based on encoder data after the connection is restored.)																											
7...15	Reserved																												
	0000 0000b ... 0111 1111b	Position counter status word.	1 = 1																										
90.38	<i>Pos counter decimals</i>	Scales the values of parameters 90.05 Load position scaled and 90.65 Pos counter init value when written from or read to from an external source (eg. fieldbus). The setting corresponds to the number of decimal places. For example, with the setting of 3, an integer value of 66770 written into 90.65 Pos counter init value is divided by 1000, so the final value applied will be 66.770. Likewise, the value of 90.05 Load position scaled is multiplied by 1000 when read.	3																										
	0...9	Number of position counter decimal places.	1 = 1																										
90.41	<i>Motor feedback selection</i>	Selects the motor speed feedback value used during motor control.	<i>Estimate</i>																										
	Estimate	A calculated speed estimate generated from the DTC core is used.	0																										
	Encoder 1	Actual speed measured by encoder 1. The encoder is set up by the parameters in group 92 Encoder 1 configuration .	1																										

No.	Name/Value	Description	Def/FbEq16
	Encoder 2	Actual speed measured by encoder 2. The encoder is set up by the parameters in group 93 Encoder 2 configuration .	2
90.42	Motor speed filter time	Defines a filter time for motor speed feedback used for control (90.01 Motor speed for control).	3 ms
	0 ... 10000 ms	Motor speed filter time.	1 = 1 ms
90.43	Motor gear numerator	Parameters 90.43 and 90.44 define a gear function between the motor speed feedback and motor control. The gear is used to correct a difference between the motor and encoder speeds for example if the encoder is not mounted directly on the motor shaft. $\frac{\text{90.43 Motor gear numerator}}{\text{90.44 Motor gear denominator}} = \frac{\text{Motor speed}}{\text{Encoder speed}}$	1
	-2147483648 ... 2147483647	Motor gear numerator.	-
90.44	Motor gear denominator	See parameter 90.43 Motor gear numerator .	1
	-2147483648 ... 2147483647	Motor gear denominator.	-
90.45	Motor feedback fault	Selects how the drive reacts to loss of measured motor feedback.	Fault
	Fault	Drive trips on a 7301 Motor speed feedback or 7381 Encoder fault.	0
	Warning	Drive generates a A7B0 Motor speed feedback or A7E1 Encoder warning and continues operation using estimated feedbacks. Note: Before using this setting, test the stability of the speed control loop with estimated feedback by running the drive on estimated feedback (see 90.41 Motor feedback selection).	1
90.46	Force open loop	Defines the speed feedback used by the DTC motor model.	No
	No	The motor model uses the feedback selected by 90.41 Motor feedback selection .	0
	Yes	The motor model uses the calculated speed estimate (regardless of the setting of 90.41 Motor feedback selection , which in this case only selects the source of feedback for the speed controller).	1
90.48	Motor position axis mode	Selects the axis type for motor position measurement.	Rollover
	Linear	Linear.	0

No.	Name/Value	Description	Def/FbEq16
	Rollover	The value is between 0 and 1 revolutions, and rolls over at 360 degrees.	1
90.49	Motor position resolution	Defines how many bits are used for motor position count within one revolution. For example, with the setting of 24, the position value is multiplied by 16777216 for display in parameter 90.06 Motor position scaled (or for fieldbus).	24
	0...31	Motor position resolution.	-
90.51	Load feedback selection	Selects the source of load speed and position feedbacks used in control.	<i>None</i>
	None	No load feedback selected.	0
	Encoder 1	Load feedbacks are updated based on the speed and position values read from encoder 1. The values are scaled by the load gear function (90.53 Load gear numerator and 90.54 Load gear denominator). The encoder is set up by the parameters in group 92 Encoder 1 configuration .	1
	Encoder 2	Load feedbacks are updated based on the speed and position values read from encoder 2. The values are scaled by the load gear function (90.53 Load gear numerator and 90.54 Load gear denominator). The encoder is set up by the parameters in group 93 Encoder 2 configuration .	2
	Estimate	Calculated speed and position estimates are used. The values are scaled from the motor side to the load side using the inverted ratio between 90.61 Gear numerator and 90.62 Gear denominator (ie. 90.62 divided by 90.61).	3
	Motor feedback	The source selected by parameter 90.41 Motor feedback selection for motor feedback is also used for load feedback. Any difference between the motor and load speeds (and positions) can be compensated by using the inverted ratio between 90.61 Gear numerator and 90.62 Gear denominator (ie. 90.62 divided by 90.61).	4
90.52	Load speed filter time	Defines a filter time for load speed feedback (90.03 Load speed).	4 ms
	0 ... 10000 ms	Load speed filter time.	-

No.	Name/Value	Description	Def/FbEq16
90.53	<i>Load gear numerator</i>	Parameters <i>90.53</i> and <i>90.54</i> define a gear function between the load (ie. driven equipment) speed and the encoder feedback selected by parameter <i>90.51 Load feedback selection</i> . The gear can be used to correct a difference between the load and encoder speeds for example if the encoder is not mounted directly on the rotated machinery. $\frac{90.53 \text{ Load gear numerator}}{90.54 \text{ Load gear denominator}} = \frac{\text{Load speed}}{\text{Encoder speed}}$	1
	-2147483648 ... 2147483647	Load gear numerator.	-
90.54	<i>Load gear denominator</i>	See parameter <i>90.53 Load gear numerator</i> .	1
	-2147483648 ... 2147483647	Load gear denominator.	-
90.55	<i>Load feedback fault</i>	Selects how the drive reacts to loss of load feedback.	<i>Fault</i>
	Fault	Drive trips on a <i>73A1 Load feedback</i> fault.	0
	Warning	Drive generates a <i>A7B1 Load speed feedback</i> warning and continues operation using estimated feedbacks.	1
90.56	<i>Load position offset</i>	Defines a load-side position offset. The resolution is determined by parameter <i>90.57 Load position resolution</i> .	0 rev
	-2147483648 ... 2147483647 rev	Load-side position offset.	-
90.57	<i>Load position resolution</i>	Defines how many bits are used for load position count within one revolution. For example, with the setting of 16, the position value is multiplied by 65536 for display in parameter <i>90.04 Load position</i> .	16
	0...31	Load position resolution.	-
90.58	<i>Pos counter init value int</i>	Defines an initial position (or distance) for the position counter (as an integer value) when parameter <i>90.59 Pos counter init value int source</i> is set to <i>Pos counter init value int</i> . See also section <i>Position counter</i> (page 54).	0
	-2147483648 ... 2147483647	Initial integer value for position counter.	-

No.	Name/Value	Description	Def/FbEq16
90.59	<i>Pos counter init value int source</i>	Selects the source of the initial position integer value. When the source selected by <i>90.67 Pos counter init cmd source</i> activates, the value selected in this parameter is assumed to be the position of the load.	<i>Pos counter init value int</i>
	Zero	0.	0
	Pos counter init value int	Parameter <i>90.58 Pos counter init value int</i> .	1
	<i>Other</i>	Source selection (see <i>Terms and abbreviations</i> on page 90).	-
90.61	<i>Gear numerator</i>	Parameters <i>90.61</i> and <i>90.62</i> define a gear function between the motor and load speeds. $\frac{90.61 \text{ Gear numerator}}{90.62 \text{ Gear denominator}} = \frac{\text{Motor speed}}{\text{Load speed}}$	1
	-2147483648 ... 2147483647	Gear numerator (motor-side).	-
90.62	<i>Gear denominator</i>	See parameter <i>90.61 Gear numerator</i> .	1
	-2147483648 ... 2147483647	Gear denominator (load-side).	-
90.63	<i>Feed constant numerator</i>	Parameters <i>90.63</i> and <i>90.64</i> define the feed constant for the position calculation: $\frac{90.63 \text{ Feed constant numerator}}{90.64 \text{ Feed constant denominator}}$ The feed constant converts rotational motion into translatory motion. The feed constant is the distance the load moves during one turn of the motor shaft. The translatory load position is shown by parameter <i>90.05 Load position scaled</i> .	1
	-2147483648 ... 2147483647	Feed constant numerator.	-
90.64	<i>Feed constant denominator</i>	See parameter <i>90.63 Feed constant numerator</i> .	1
	-2147483648 ... 2147483647	Feed constant denominator.	-

No.	Name/Value	Description	Def/FbEq16
90.65	<i>Pos counter init value</i>	Defines an initial position (or distance) for the position counter (as a decimal number) when parameter <i>90.66 Pos counter init value source</i> is set to <i>Pos counter init value</i> . The number of decimal places is defined by parameter <i>90.38 Pos counter decimals</i> .	0.000
	-2147483.648 ... 2147483.647	Initial value for position counter.	-
90.66	<i>Pos counter init value source</i>	Selects the source of the initial position value. When the source selected by <i>90.67 Pos counter init cmd source</i> activates, the value selected in this parameter is assumed to be the position of the load (in decimal format).	<i>Pos counter init value</i>
	Zero	0.	0
	Pos counter init value	Parameter <i>90.65 Pos counter init value</i> .	1
	<i>Other</i>	Source selection (see <i>Terms and abbreviations</i> on page 90).	-
90.67	<i>Pos counter init cmd source</i>	Selects a digital source (for example, a limit switch connected to a digital input) that initializes the position counter. When the digital source activates, the value selected by <i>90.66 Pos counter init value source</i> is assumed to be the position of the load. Note: Position counter initialization can be prevented by parameter <i>90.68 Disable pos counter initialization</i> .	<i>Not selected</i>
	Not selected	0.	0
	Selected	1.	1
	DI1	Digital input DI1 (<i>10.02 DI delayed status</i> , bit 0).	2
	DI2	Digital input DI2 (<i>10.02 DI delayed status</i> , bit 1).	3
	DI3	Digital input DI3 (<i>10.02 DI delayed status</i> , bit 2).	4
	DI4	Digital input DI4 (<i>10.02 DI delayed status</i> , bit 3).	5
	DI5	Digital input DI5 (<i>10.02 DI delayed status</i> , bit 4).	6
	DI6	Digital input DI6 (<i>10.02 DI delayed status</i> , bit 5).	7
	DIO1	Digital input/output DIO1 (<i>11.02 DIO delayed status</i> , bit 0).	10
	DIO2	Digital input/output DIO2 (<i>11.02 DIO delayed status</i> , bit 1).	11
	<i>Other [bit]</i>	Source selection (see <i>Terms and abbreviations</i> on page 90).	-

No.	Name/Value	Description	Def/FbEq16
90.68	<i>Disable pos counter initialization</i>	Selects a source that prevents the initialization of the position counter.	<i>Not selected</i>
	Not selected	0.	0
	Selected	1.	1
	DI1	Digital input DI1 (<i>10.02 DI delayed status</i> , bit 0).	2
	DI2	Digital input DI2 (<i>10.02 DI delayed status</i> , bit 1).	3
	DI3	Digital input DI3 (<i>10.02 DI delayed status</i> , bit 2).	4
	DI4	Digital input DI4 (<i>10.02 DI delayed status</i> , bit 3).	5
	DI5	Digital input DI5 (<i>10.02 DI delayed status</i> , bit 4).	6
	DI6	Digital input DI6 (<i>10.02 DI delayed status</i> , bit 5).	7
	DIO1	Digital input/output DIO1 (<i>11.02 DIO delayed status</i> , bit 0).	10
	DIO2	Digital input/output DIO2 (<i>11.02 DIO delayed status</i> , bit 1).	11
	<i>Other [bit]</i>	Source selection (see <i>Terms and abbreviations</i> on page 90).	-
90.69	<i>Reset pos counter init ready</i>	Selects a source that enables a new initialization of the position counter, ie. resets bit 4 of <i>90.35 Pos counter status</i> .	<i>Not selected</i>
	Not selected	0.	0
	Selected	1.	1
	DI1	Digital input DI1 (<i>10.02 DI delayed status</i> , bit 0).	2
	DI2	Digital input DI2 (<i>10.02 DI delayed status</i> , bit 1).	3
	DI3	Digital input DI3 (<i>10.02 DI delayed status</i> , bit 2).	4
	DI4	Digital input DI4 (<i>10.02 DI delayed status</i> , bit 3).	5
	DI5	Digital input DI5 (<i>10.02 DI delayed status</i> , bit 4).	6
	DI6	Digital input DI6 (<i>10.02 DI delayed status</i> , bit 5).	7
	DIO1	Digital input/output DIO1 (<i>11.02 DIO delayed status</i> , bit 0).	10
	DIO2	Digital input/output DIO2 (<i>11.02 DIO delayed status</i> , bit 1).	11
	<i>Other [bit]</i>	Source selection (see <i>Terms and abbreviations</i> on page 90).	-

No.	Name/Value	Description	Def/FbEq16																					
91 Encoder module settings		Configuration of encoder interface modules.																						
91.01	<i>FEN DI status</i>	Displays the status of the digital inputs of FEN-xx encoder interface modules. This parameter is read-only.	-																					
<table border="1"> <thead> <tr> <th>Bit</th> <th>Name</th> <th>Information</th> </tr> </thead> <tbody> <tr> <td>0</td> <td>DI1 /module 1</td> <td>DI1 of interface module 1 (see parameters 91.11 and 91.12)</td> </tr> <tr> <td>1</td> <td>DI2 /module 1</td> <td>DI2 of interface module 1 (see parameters 91.11 and 91.12)</td> </tr> <tr> <td>2...3</td> <td colspan="2">Reserved</td> </tr> <tr> <td>4</td> <td>DI1 /module 2</td> <td>DI1 of interface module 2 (see parameters 91.13 and 91.14)</td> </tr> <tr> <td>5</td> <td>DI2 /module 2</td> <td>DI2 of interface module 2 (see parameters 91.13 and 91.14)</td> </tr> <tr> <td>6...15</td> <td colspan="2">Reserved</td> </tr> </tbody> </table>				Bit	Name	Information	0	DI1 /module 1	DI1 of interface module 1 (see parameters 91.11 and 91.12)	1	DI2 /module 1	DI2 of interface module 1 (see parameters 91.11 and 91.12)	2...3	Reserved		4	DI1 /module 2	DI1 of interface module 2 (see parameters 91.13 and 91.14)	5	DI2 /module 2	DI2 of interface module 2 (see parameters 91.13 and 91.14)	6...15	Reserved	
Bit	Name	Information																						
0	DI1 /module 1	DI1 of interface module 1 (see parameters 91.11 and 91.12)																						
1	DI2 /module 1	DI2 of interface module 1 (see parameters 91.11 and 91.12)																						
2...3	Reserved																							
4	DI1 /module 2	DI1 of interface module 2 (see parameters 91.13 and 91.14)																						
5	DI2 /module 2	DI2 of interface module 2 (see parameters 91.13 and 91.14)																						
6...15	Reserved																							
	0000 0000b ... 0011 0011b	Status word of digital inputs on FEN-xx modules.	1 = 1																					
91.02	<i>Module 1 status</i>	Displays the type of the interface module found in the location specified by parameter 91.12 Module 1 location . This parameter is read-only.	-																					
	No option	No module detected in the specified slot.	0																					
	No communication	A module has been detected but cannot be communicated with.	1																					
	Unknown	The module type is unknown.	2																					
	FEN-01	An FEN-01 module has been detected and is active.	16																					
	FEN-11	An FEN-11 module has been detected and is active.	17																					
	FEN-21	An FEN-21 module has been detected and is active.	18																					
	FEN-31	An FEN-31 module has been detected and is active.	21																					
	FSE-31	An FSE-31 module has been detected and is active.	25																					

No.	Name/Value	Description	Def/FbEq16
91.03	<i>Module 2 status</i>	Displays the type of the interface module found in the location specified by parameter <i>91.14 Module 2 location</i> . For the indications, see parameter <i>91.02 Module 1 status</i> . This parameter is read-only.	-
91.04	<i>Module 1 temperature</i>	Displays the temperature measured through the sensor input of interface module 1. The unit is selected by parameter <i>96.16 Unit selection</i> . Note: With a PTC sensor, the unit is ohms. This parameter is read-only.	-
	0...1000 °C, °F or ohm	Temperature measured through interface module 1.	-
91.06	<i>Module 2 temperature</i>	Displays the temperature measured through the sensor input of interface module 2. The unit is selected by parameter <i>96.16 Unit selection</i> . Note: With a PTC sensor, the unit is ohms. This parameter is read-only.	-
	0...1000 °C, °F or ohm	Temperature measured through interface module 2.	-
91.10	<i>Encoder parameter refresh</i>	Validates any changed encoder interface module parameters. This is needed for any parameter changes in groups 90...93 to take effect. After refreshing, the value reverts automatically to <i>Done</i> . Note: The parameter cannot be changed while the drive is running.	<i>Done</i>
	Done	Refreshing done.	0
	Refresh	Refreshing.	1
91.11	<i>Module 1 type</i>	Defines the type of the module used as interface module 1.	<i>None</i>
	None	None (communication disabled).	0
	FEN-01	FEN-01.	1
	FEN-11	FEN-11.	2
	FEN-21	FEN-21.	3
	FEN-31	FEN-31.	4
	FSE-31	FSE-31.	5
91.12	<i>Module 1 location</i>	Specifies the slot (1...3) on the control unit of the drive into which the interface module is installed.	<i>Slot 2</i>
	Slot 1	Slot 1.	1
	Slot 2	Slot 2.	2
	Slot 3	Slot 3.	3

No.	Name/Value	Description	Def/FbEq16
91.13	<i>Module 2 type</i>	Defines the type of the module used as interface module 2.	<i>None</i>
	None	None (communication disabled).	0
	FEN-01	FEN-01.	1
	FEN-11	FEN-11.	2
	FEN-21	FEN-21.	3
	FEN-31	FEN-31.	4
	FSE-31	FSE-31.	5
91.14	<i>Module 2 location</i>	Specifies the slot (1...3) on the control unit of the drive into which the interface module is installed.	<i>Slot 3</i>
	Slot 1	Slot 1.	1
	Slot 2	Slot 2.	2
	Slot 3	Slot 3.	3
91.21	<i>Module 1 temp sensor type</i>	Specifies the type of temperature sensor connected to interface module 1.	<i>None</i>
	None	None.	0
	PTC	PTC. (The unit is ohms.)	1
	KTY-84	KTY84. (The unit is selected by parameter 96.16 Unit selection .)	2
91.22	<i>Module 1 temp filter time</i>	Defines a filtering time for the temperature measurement through interface module 1.	1500 ms
	0...10000 ms	Filtering time for temperature measurement.	-
91.24	<i>Module 2 temp sensor type</i>	Specifies the type of temperature sensor connected to interface module 2.	<i>None</i>
	None	None.	0
	PTC	PTC. (The unit is ohms.)	1
	KTY-84	KTY84. (The unit is selected by parameter 96.16 Unit selection .)	2
91.25	<i>Module 2 temp filter time</i>	Defines a filtering time for the temperature measurement through interface 2.	1500 ms
	0...10000 ms	Filtering time for temperature measurement.	-
91.31	<i>Module 1 TTL output source</i>	Selects the encoder input on interface module 1 whose signal is echoed by or emulated to the TTL output. See also section Encoder support (page 52).	<i>Not selected</i>
	Not selected	TTL output not in use.	0
	Module input 1	Input 1 is echoed by or emulated to the TTL output.	1
	Module input 2	Input 2 is echoed by or emulated to the TTL output.	2

No.	Name/Value	Description	Def/FbEq16
91.32	<i>Module 1 emulation pulses/rev</i>	Defines the number of TTL pulses per revolution for encoder emulation output of interface module 1.	0
	0...65535	Number of TTL pulses for emulation.	1 = 1
91.33	<i>Module 1 emulated Z-pulse offset</i>	With interface module 1, defines when zero pulses are emulated in relation to zero position received from the encoder. For example, with a value of 0.50000, a zero pulse is emulated whenever the encoder position passes 0.5 revolutions. With a value of 0.00000, a zero pulse is emulated whenever the encoder position passes zero position.	0.00000
	0.00000 ... 1.00000 rev	Position of emulated zero pulses.	32767 = 1 rev
91.41	<i>Module 2 TTL output source</i>	Selects the encoder input on interface module 2 whose signal is echoed by or emulated to the TTL output. See also section <i>Encoder support</i> (page 52).	<i>Not selected</i>
	Not selected	TTL output not in use.	0
	Module input 1	Input 1 is echoed by or emulated to the TTL output.	1
	Module input 2	Input 2 is echoed by or emulated to the TTL output.	2
91.42	<i>Module 2 emulation pulses/rev</i>	Defines the number of TTL pulses per revolution for encoder emulation output of interface module 2.	0
	0...65535	Number of TTL pulses for emulation.	1 = 1
91.43	<i>Module 2 emulated Z-pulse offset</i>	With interface module 2, defines when zero pulses are emulated in relation to zero position received from the encoder. For example, with a value of 0.50000, a zero pulse is emulated whenever the encoder position passes 0.5 revolutions. With a value of 0.00000, a zero pulse is emulated whenever the encoder position passes zero position.	0
	0.00000 ... 1.00000 rev	Position of emulated zero pulses.	32767 = 1 rev

No.	Name/Value	Description	Def/FbEq16
92 Encoder 1 configuration		Settings for encoder 1. Notes: <ul style="list-style-type: none"> The contents of the parameter group vary according to the selected encoder type. It is recommended that encoder connection 1 (this group) is used whenever possible since the data received through that interface is fresher than the data received through connection 2 (group 93 Encoder 2 configuration). 	
92.01	Encoder 1 type	Selects the type of encoder/resolver 1.	<i>None configured</i>
	None configured	None.	0
	TTL	TTL. Module type (input): FEN-01 (X31), FEN-11 (X41) or FEN-21 (X51).	1
	TTL+	TTL+ (with commutation signals). Module type (input): FEN-01 (X32).	2
	Absolute encoder	Absolute encoder. Module type (input): FEN-11 (X42).	3
	Resolver	Resolver. Module type (input): FEN-21 (X52).	4
	HTL	HTL. Module type (input): FEN-31 (X82).	5
	HTL 1	HTL. Module type (input): FSE-31 (X31).	6
	HTL 2	HTL. Module type (input): FSE-31 (X32).	7
	TTL 1	TTL. Module type (input): FSE-31 (X31).	8
	TTL 2	TTL. Module type (input): FSE-31 (X32).	9
92.02	Encoder 1 source	Selects the interface module that the encoder is connected to. (The physical locations and types of encoder interface modules are defined in parameter group 91 Encoder module settings .)	<i>Module 1</i>
	Module 1	Interface module 1.	0
	Module 2	Interface module 2.	1
92.10	Pulses/revolution	<i>(Visible when a TTL, TTL+ or HTL encoder is selected)</i> Defines the pulse number per revolution.	2048
	0..65535	Number of pulses.	-
92.10	Sine/cosine number	<i>(Visible when an absolute encoder is selected)</i> Defines the number of sine/cosine wave cycles within one revolution. Note: This parameter need not be set when an EnDat or SSI encoder is used in continuous mode. See parameter 92.30 Serial link mode .	0
	0..65535	Number of sine/cosine wave cycles within one revolution.	-

No.	Name/Value	Description	Def/FbEq16
92.10	<i>Excitation signal frequency</i>	(Visible when a resolver is selected) Defines the frequency of the excitation signal.	1 kHz
	1...20 kHz	Excitation signal frequency.	1 = 1 kHz
92.11	<i>Pulse encoder type</i>	(Visible when a TTL, TTL+ or HTL encoder is selected) Selects the type of encoder.	<i>Quadrature</i>
	Quadrature	Quadrature encoder (with two channels, A and B)	0
	Single track	Single-track encoder (with one channel, A). Note: With this setting, the measured speed value is always positive regardless of direction of rotation.	1
92.11	<i>Absolute position source</i>	(Visible when an absolute encoder is selected) Selects the source of the absolute position information.	<i>None</i>
	None	Not selected.	0
	Commut signals	Commutation signals.	1
	EnDat	Serial interface: EnDat encoder.	2
	Hiperface	Serial interface: HIPERFACE encoder.	3
	SSI	Serial interface: SSI encoder.	4
	Tamagawa	Serial interface: Tamagawa 17/33-bit encoder.	5
92.11	<i>Excitation signal amplitude</i>	(Visible when a resolver is selected) Defines the amplitude of the excitation signal.	4.0 V
	4.0 ... 12.0 V	Excitation signal amplitude.	10 = 1 V
92.12	<i>Speed calculation mode</i>	(Visible when a TTL, TTL+ or HTL encoder is selected) Selects the speed calculation mode. *With a single-track encoder (parameter 92.11 <i>Pulse encoder type</i> is set to <i>Single track</i>), the speed is always positive.	<i>Auto rising</i>
	A&B all	Channels A and B: Rising and falling edges are used for speed calculation. *Channel B: Defines the direction of rotation. Note: With a single-track encoder (parameter 92.11 <i>Pulse encoder type</i>), this setting acts like setting <i>A all</i> .	0
	A all	Channel A: Rising and falling edges are used for speed calculation. *Channel B: Defines the direction of rotation.	1
	A rising	Channel A: Rising edges are used for speed calculation. *Channel B: Defines the direction of rotation.	2

No.	Name/Value	Description	Def/FbEq16								
	A falling	Channel A: Falling edges are used for speed calculation. *Channel B: Defines the direction of rotation.	3								
	Auto rising	One of the above modes is selected automatically depending on the pulse frequency as follows: <table border="1" data-bbox="570 465 1232 672"> <thead> <tr> <th>Pulse frequency of the channel(s)</th> <th>Used mode</th> </tr> </thead> <tbody> <tr> <td>< 2442 Hz</td> <td><i>A&B all</i></td> </tr> <tr> <td>2442...4884 Hz</td> <td><i>A all</i></td> </tr> <tr> <td>> 4884 Hz</td> <td><i>A rising</i></td> </tr> </tbody> </table>	Pulse frequency of the channel(s)	Used mode	< 2442 Hz	<i>A&B all</i>	2442...4884 Hz	<i>A all</i>	> 4884 Hz	<i>A rising</i>	4
Pulse frequency of the channel(s)	Used mode										
< 2442 Hz	<i>A&B all</i>										
2442...4884 Hz	<i>A all</i>										
> 4884 Hz	<i>A rising</i>										
	Auto falling	One of the above modes is selected automatically depending on the pulse frequency as follows: <table border="1" data-bbox="570 810 1232 1016"> <thead> <tr> <th>Pulse frequency of the channel(s)</th> <th>Used mode</th> </tr> </thead> <tbody> <tr> <td>< 2442 Hz</td> <td><i>A&B all</i></td> </tr> <tr> <td>2442...4884 Hz</td> <td><i>A all</i></td> </tr> <tr> <td>> 4884 Hz</td> <td><i>A falling</i></td> </tr> </tbody> </table>	Pulse frequency of the channel(s)	Used mode	< 2442 Hz	<i>A&B all</i>	2442...4884 Hz	<i>A all</i>	> 4884 Hz	<i>A falling</i>	5
Pulse frequency of the channel(s)	Used mode										
< 2442 Hz	<i>A&B all</i>										
2442...4884 Hz	<i>A all</i>										
> 4884 Hz	<i>A falling</i>										
92.12	<i>Zero pulse enable</i>	<i>(Visible when an absolute encoder is selected)</i> Enables the encoder zero pulse for the absolute encoder input (X42) of the FEN-11 interface module. Note: No zero pulse exists with serial interfaces, ie. when parameter <i>92.11 Absolute position source</i> is set to <i>EnDat</i> , <i>Hiperface</i> , <i>SSI</i> or <i>Tamagawa</i> .	<i>Disable</i>								
	Disable	Zero pulse disabled.	0								
	Enable	Zero pulse enabled.	1								
92.12	<i>Resolver polepairs</i>	<i>(Visible when a resolver is selected)</i> Defines the number of pole pairs of the resolver.	1								
	1...32	Number of resolver pole pairs.	1 = 1								
92.13	<i>Position estimation enable</i>	<i>(Visible when a TTL, TTL+ or HTL encoder is selected)</i> Selects whether position estimation is used with encoder 1 to increase position data resolution or not.	<i>Enable</i>								
	Disable	Measured position used. (The resolution is 4 × pulses per revolution for quadrature encoders, 2 × pulses per revolution for single-track encoders.)	0								
	Enable	Estimated position used. (Uses position interpolation; extrapolated at the time of data request.)	1								

No.	Name/Value	Description	Def/FbEq16
92.13	<i>Position data width</i>	(Visible when an absolute encoder is selected) Defines the number of bits used to indicate position within one revolution. For example, a setting of 15 bits corresponds to 32768 positions per revolution. The value is used when parameter <i>92.11 Absolute position source</i> is set to <i>EnDat</i> , <i>Hiperface</i> or <i>SSI</i> . When parameter <i>92.11 Absolute position source</i> is set to <i>Tamagawa</i> , this parameter is internally set to 17.	0
	0...32	Number of bits used in position indication within one revolution.	1 = 1
92.14	<i>Speed estimation enable</i>	(Visible when a TTL, TTL+ or HTL encoder is selected) Selects whether calculated or estimated speed is used. Estimation increases the speed ripple in steady state operation, but improves the dynamics. Note: This parameter is not effective with FEN-xx modules with FPGA version VIEx 2000 or later.	<i>Disable</i>
	Disable	Last calculated speed used. (The calculation interval is 62.5 microseconds to 4 milliseconds.)	0
	Enable	Estimated speed (estimated at the time of data request) is used.	1
92.14	<i>Revolution data width</i>	(Visible when an absolute encoder is selected) Defines the number of bits used in revolution counting with a multturn encoder. For example, a setting of 12 bits would support counting up to 4096 revolutions. The value is used when parameter <i>92.11 Absolute position source</i> is set to <i>EnDat</i> , <i>Hiperface</i> or <i>SSI</i> . When parameter <i>92.11 Absolute position source</i> is set to <i>Tamagawa</i> , setting this parameter to a non-zero value activates multturn data requesting.	0
	0...32	Number of bits used in revolution count.	1 = 1
92.15	<i>Transient filter</i>	(Visible when a TTL, TTL+ or HTL encoder is selected) Activates transient filtering for the encoder (changes in direction of rotation are ignored above the selected pulse frequency).	<i>4780 Hz</i>
	4780 Hz	Change in direction of rotation allowed below 4780 Hz.	0
	2440 Hz	Change in direction of rotation allowed below 2440 Hz.	1

No.	Name/Value	Description	Def/FbEq16
	1220 Hz	Change in direction of rotation allowed below 1220 Hz.	2
	Disabled	Change in direction of rotation allowed at any pulse frequency.	3
92.16	<i>Encoder 1 supply voltage</i>	(Visible when parameter 92.01 Encoder 1 type = HTL 1, HTL 2, TTL 1 or TTL 2) Selects the power supply voltage for encoder 1.	0V
	0V	Disabled.	0
	5V	5 V.	1
	24V	24 V.	2
92.17	<i>Accepted pulse freq of encoder 1</i>	(Visible when parameter 92.01 Encoder 1 type = HTL 1, HTL 2, TTL 1 or TTL 2) Defines the maximum pulse frequency of encoder 1.	0 kHz
	0...300 kHz	Pulse frequency.	1 = 1 kHz
92.21	<i>Encoder cable fault mode</i>	(Visible when a TTL, TTL+ or HTL encoder is selected) Selects which encoder cable channels and wires are monitored for wiring faults.	A, B
	A, B	A and B.	0
	A, B, Z	A, B and Z.	1
	A+, A-, B+, B-	A+, A-, B+ and B-.	2
	A+, A-, B+, B-, Z+, Z-	A+, A-, B+, B-, Z+ and Z-.	3
92.23	<i>Maximum pulse waiting time</i>	(Visible when parameter 92.01 Encoder 1 type = TTL or HTL) Determines a pulse waiting time used in speed calculation for the encoder interface. If no pulse edges are detected within this time, the measured speed is zeroed by the interface. Increasing the setting can improve measuring performance especially at low, near zero speeds. Notes: <ul style="list-style-type: none"> The parameter is only supported by FEN-xx modules with FPGA version VIEx 2000 or later. On older modules, the pulse waiting time is fixed to 4 ms. The parameter only affects speed measurement. Position is updated whenever a new pulse edge is detected. When the measured speed from the interface is zero, the drive updates its speed data based on position changes. 	4 ms
	1...200 ms	Maximum pulse waiting time.	1 = 1 ms

No.	Name/Value	Description	Def/FbEq16
92.24	<i>Pulse edge filtering</i>	<p>(Visible when parameter 92.01 Encoder 1 type = HTL)</p> <p>Enables pulse edge filtering. Pulse edge filtering can improve the reliability of measurements especially from encoders with a single-ended connection.</p> <p>Notes:</p> <ul style="list-style-type: none"> Pulse edge filtering is only supported by FEN-31 modules with FPGA version VIE3 2200 or later. Pulse edge filtering decreases the maximum pulse frequency. With 2 µs filtering time, the maximum pulse frequency is 200 kHz. 	<i>No filtering</i>
	No filtering	Filtering disabled.	0
	1 µs	Filtering time: 1 microsecond.	1
	2 µs	Filtering time: 2 microseconds.	2
92.25	<i>Pulse overfrequency function</i>	<p>(Visible when parameter 92.01 Encoder 1 type = HTL)</p> <p>Selects how the drive reacts when the encoder interface detects a pulse overfrequency condition.</p> <p>Note: This parameter is effective only with FEN-xx module FPGA version VIEx 2200 or later.</p>	<i>Fault</i>
	Warning	The drive generates a warning, <i>7381 Encoder</i> . The FEN-xx module will continue to update speed and position data.	0
	Fault	The drive trips on fault <i>A7E1 Encoder</i> .	1
92.30	<i>Serial link mode</i>	<p>(Visible when an absolute encoder is selected)</p> <p>Selects the serial link mode with an EnDat or SSI encoder.</p>	<i>Initial position</i>
	Initial position	Single position transfer mode (initial position).	0
	Continuous	Continuous position data transfer mode.	1
	Continuous speed and position	<p>Continuous speed and position data transfer mode. This setting is intended for EnDat 2.2 encoders without sin/cos signals.</p> <p>Note: This setting requires an FEN-11 interface revision H or later.</p>	2

No.	Name/Value	Description	Def/FbEq16
92.31	<i>EnDat max calculation time</i>	<i>(Visible when an absolute encoder is selected)</i> Selects the maximum encoder calculation time for an EnDat encoder. Note: This parameter needs to be set only when an EnDat encoder is used in continuous mode, ie. without incremental sin/cos signals (supported only as encoder 1). See also parameter 92.30 Serial link mode .	<i>50 ms</i>
	10 us	10 microseconds.	0
	100 us	100 microseconds.	1
	1 ms	1 millisecond.	2
	50 ms	50 milliseconds.	3
92.32	<i>SSI cycle time</i>	<i>(Visible when an absolute encoder is selected)</i> Selects the transmission cycle for an SSI encoder. Note: This parameter needs to be set only when an SSI encoder is used in continuous mode, ie. without incremental sin/cos signals (supported only as encoder 1). See also parameter 92.30 Serial link mode .	<i>100 us</i>
	50 us	50 microseconds.	0
	100 us	100 microseconds.	1
	200 us	200 microseconds.	2
	500 us	500 microseconds.	3
	1 ms	1 millisecond.	4
	2 ms	2 milliseconds.	5
92.33	<i>SSI clock cycles</i>	<i>(Visible when an absolute encoder is selected)</i> Defines the length of an SSI message. The length is defined as the number of clock cycles. The number of cycles can be calculated by adding 1 to the number of bits in an SSI message frame.	2
	2...127	SSI message length.	-
92.34	<i>SSI position msb</i>	<i>(Visible when an absolute encoder is selected)</i> With an SSI encoder, defines the location of the MSB (most significant bit) of the position data within an SSI message.	1
	1...126	Position data MSB location (bit number).	-
92.35	<i>SSI revolution msb</i>	<i>(Visible when an absolute encoder is selected)</i> With an SSI encoder, defines the location of the MSB (most significant bit) of the revolution count within an SSI message.	1
	1...126	Revolution count MSB location (bit number).	-

402 Parameters

No.	Name/Value	Description	Def/FbEq16
92.36	<i>SSI data format</i>	(Visible when an absolute encoder is selected) Selects the data format for an SSI encoder.	<i>Binary</i>
	Binary	Binary code.	0
	Gray	Gray code.	1
92.37	<i>SSI baud rate</i>	(Visible when an absolute encoder is selected) Selects the baud rate for an SSI encoder.	<i>100 kBit/s</i>
	10 kBit/s	10 kbit/s.	0
	50 kBit/s	50 kbit/s.	1
	100 kBit/s	100 kbit/s.	2
	200 kBit/s	200 kbit/s.	3
	500 kBit/s	500 kbit/s.	4
	1000 kBit/s	1000 kbit/s.	5
92.40	<i>SSI zero phase</i>	(Visible when an absolute encoder is selected) Defines the phase angle within one sine/cosine signal period that corresponds to the value of zero on the SSI serial link data. The parameter is used to adjust the synchronization of the SSI position data and the position based on sine/cosine incremental signals. Incorrect synchronization may cause an error of ± 1 incremental period. Note: This parameter needs to be set only when an SSI encoder is used in initial position mode (see parameter 92.30 Serial link mode).	<i>315-45 deg</i>
	315-45 deg	315-45 degrees.	0
	45-135 deg	45-135 degrees.	1
	135-225 deg	135-225 degrees.	2
	225-315 deg	225-315 degrees.	3
92.45	<i>Hiperface parity</i>	(Visible when an absolute encoder is selected) Defines the use of parity and stop bits with a HIPERFACE encoder. Typically this parameter need not be set.	<i>Odd</i>
	Odd	Odd parity indication bit, one stop bit.	0
	Even	Even parity indication bit, one stop bit.	1
92.46	<i>Hiperface baud rate</i>	(Visible when an absolute encoder is selected) Defines the transfer rate of the link with a HIPERFACE encoder. Typically this parameter need not be set.	<i>4800 bits/s</i>
	4800 bits/s	4800 bit/s.	0
	9600 bits/s	9600 bit/s.	1
	19200 bits/s	19200 bit/s.	2
	38400 bits/s	38400 bit/s.	3

No.	Name/Value	Description	Def/FbEq16
92.47	<i>Hiperface node address</i>	(Visible when an absolute encoder is selected) Defines the node address for a HIPERFACE encoder. Typically this parameter need not be set.	64
	0...255	HIPERFACE encoder node address.	-
93 Encoder 2 configuration		Settings for encoder 2. Notes: <ul style="list-style-type: none"> The contents of the parameter group vary according to the selected encoder type. It is recommended that encoder connection 1 (group 92 Encoder 1 configuration) is used whenever possible since the data received through that interface is fresher than the data received through connection 2 (this group). 	
93.01	<i>Encoder 2 type</i>	Selects the type of encoder/resolver 2.	<i>None configured</i>
	None configured	None.	0
	TTL	TTL. Module type (input): FEN-01 (X31), FEN-11 (X41) or FEN-21 (X51).	1
	TTL+	TTL+ (with commutation signals). Module type (input): FEN-01 (X32).	2
	Absolute encoder	Absolute encoder. Module type (input): FEN-11 (X42).	3
	Resolver	Resolver. Module type (input): FEN-21 (X52).	4
	HTL	HTL. Module type (input): FEN-31 (X82).	5
	HTL 1	HTL. Module type (input): FSE-31 (X31).	6
	HTL 2	HTL. Module type (input): FSE-31 (X32).	7
	TTL 1	TTL. Module type (input): FSE-31 (X31).	8
	TTL 2	TTL. Module type (input): FSE-31 (X32).	9
93.02	<i>Encoder 2 source</i>	Selects the interface module that the encoder is connected to. (The physical locations and types of encoder interface modules are defined in parameter group 91 Encoder module settings .)	<i>Module 1</i>
	Module 1	Interface module 1.	1
	Module 2	Interface module 2.	2
93.10	<i>Pulses/rev</i>	(Visible when a TTL, TTL+ or HTL encoder is selected) See parameter 92.10 Pulses/revolution .	2048
93.10	<i>Sine/cosine number</i>	(Visible when an absolute encoder is selected) See parameter 92.10 Sine/cosine number .	0

404 Parameters

No.	Name/Value	Description	Def/FbEq16
93.10	<i>Excitation signal frequency</i>	(Visible when a resolver is selected) See parameter 92.10 Excitation signal frequency .	1 kHz
93.11	<i>Pulse encoder type</i>	(Visible when a TTL, TTL+ or HTL encoder is selected) See parameter 92.11 Pulse encoder type .	<i>Quadrature</i>
93.11	<i>Absolute position source</i>	(Visible when an absolute encoder is selected) See parameter 92.11 Absolute position source .	<i>None</i>
93.11	<i>Excitation signal amplitude</i>	(Visible when a resolver is selected) See parameter 92.11 Excitation signal amplitude .	4.0 V
93.12	<i>Speed calculation mode</i>	(Visible when a TTL, TTL+ or HTL encoder is selected) See parameter 92.12 Speed calculation mode .	<i>Auto rising</i>
93.12	<i>Zero pulse enable</i>	(Visible when an absolute encoder is selected) See parameter 92.12 Zero pulse enable .	<i>Disable</i>
93.12	<i>Resolver polepairs</i>	(Visible when a resolver is selected) See parameter 92.12 Resolver polepairs .	1
93.13	<i>Position estimation enable</i>	(Visible when a TTL, TTL+ or HTL encoder is selected) See parameter 92.13 Position estimation enable .	<i>Enable</i>
93.13	<i>Position data width</i>	(Visible when an absolute encoder is selected) See parameter 92.13 Position data width .	0
93.14	<i>Speed estimation enable</i>	(Visible when a TTL, TTL+ or HTL encoder is selected) See parameter 92.14 Speed estimation enable .	<i>Disable</i>
93.14	<i>Revolution data width</i>	(Visible when an absolute encoder is selected) See parameter 92.14 Revolution data width .	0
93.15	<i>Transient filter</i>	(Visible when a TTL, TTL+ or HTL encoder is selected) See parameter 92.15 Transient filter .	<i>4780 Hz</i>
93.16	<i>Encoder 2 supply voltage</i>	(Visible when parameter 93.01 Encoder 2 type = <i>HTL 1, HTL 2, TTL 1 or TTL 2</i>) See parameter 92.16 Encoder 1 supply voltage .	<i>0V</i>
93.17	<i>Accepted pulse freq of encoder 2</i>	(Visible when parameter 93.01 Encoder 2 type = <i>HTL 1, HTL 2, TTL 1 or TTL 2</i>) See parameter 92.17 Accepted pulse freq of encoder 1 .	0 kHz
93.21	<i>Encoder cable fault mode</i>	(Visible when a TTL, TTL+ or HTL encoder is selected) See parameter 92.21 Encoder cable fault mode .	<i>A, B</i>

No.	Name/Value	Description	Def/FbEq16
93.23	Maximum pulse waiting time	(Visible when parameter 93.01 Encoder 2 type = TTL or HTL) See parameter 92.23 Maximum pulse waiting time.	4 ms
93.24	Pulse edge filtering	(Visible when parameter 93.01 Encoder 2 type = HTL) See parameter 92.24 Pulse edge filtering.	No filtering
93.25	Pulse overfrequency function	(Visible when parameter 93.01 Encoder 2 type = HTL) See parameter 92.25 Pulse overfrequency function.	Fault
93.30	Serial link mode	(Visible when an absolute encoder is selected) See parameter 92.30 Serial link mode.	Initial position
93.31	EnDat calc time	(Visible when an absolute encoder is selected) See parameter 92.31 EnDat max calculation time.	50 ms
93.32	SSI cycle time	(Visible when an absolute encoder is selected) See parameter 92.32 SSI cycle time.	100 us
93.33	SSI clock cycles	(Visible when an absolute encoder is selected) See parameter 92.33 SSI clock cycles.	2
93.34	SSI position msb	(Visible when an absolute encoder is selected) See parameter 92.34 SSI position msb.	1
93.35	SSI revolution msb	(Visible when an absolute encoder is selected) See parameter 92.35 SSI revolution msb.	1
93.36	SSI data format	(Visible when an absolute encoder is selected) See parameter 92.36 SSI data format.	Binary
93.37	SSI baud rate	(Visible when an absolute encoder is selected) See parameter 92.37 SSI baud rate.	100 kBit/s
93.40	SSI zero phase	(Visible when an absolute encoder is selected) See parameter 92.40 SSI zero phase.	315-45 deg
93.45	Hiperface parity	(Visible when an absolute encoder is selected) See parameter 92.45 Hiperface parity.	Odd
93.46	Hiperface baud rate	(Visible when an absolute encoder is selected) See parameter 92.46 Hiperface baud rate.	4800 bits/s
93.47	Hiperface node address	(Visible when an absolute encoder is selected) See parameter 92.47 Hiperface node address.	64

No.	Name/Value	Description	Def/FbEq16
95 HW configuration		Various hardware-related settings.	
95.01	<i>Supply voltage</i>	<p>Selects the supply voltage range. This parameter is used by the drive to determine the nominal voltage of the supply network. The parameter also affects the current ratings and the DC voltage control functions (trip and brake chopper activation limits) of the drive.</p> <p> WARNING! An incorrect setting may cause the motor to rush uncontrollably, or the brake chopper or resistor to overload.</p> <p>Note: The selections shown depend on the hardware of the drive. If only one voltage range is valid for the drive in question, it is selected by default.</p>	-
	Not given	No voltage range selected. The drive will not start modulating before a range is selected.	0
	208...240 V	208...240 V	1
	380...415 V	380...415 V	2
	440...480 V	440...480 V	3
	500 V	500 V	4
	525...600 V	525...600 V	5
	660...690 V	660...690 V	6
95.02	<i>Adaptive voltage limits</i>	<p>Enables adaptive voltage limits.</p> <p>Adaptive voltage limits can be used if, for example, an IGBT supply unit is used to raise the DC voltage level. If the communication between the inverter and IGBT supply unit is active, the voltage limits are related to the DC voltage reference from the IGBT supply unit. Otherwise the limits are calculated based on the measured DC voltage at the end of the pre-charging sequence.</p> <p>This function is also useful if the AC supply voltage to the drive is high, as the warning levels are raised accordingly.</p>	<i>Disable</i>
	Disable	Adaptive voltage limits disabled.	0
	Enable	Adaptive voltage limits enabled.	1
95.04	<i>Control board supply</i>	Specifies how the control unit of the drive is powered.	<i>Internal 24V;</i> <i>External 24V</i> <i>(95.20 b4)</i>
	Internal 24V	The drive control unit is powered from the drive power unit it is connected to.	0
	External 24V	The drive control unit is powered from an external power supply.	1

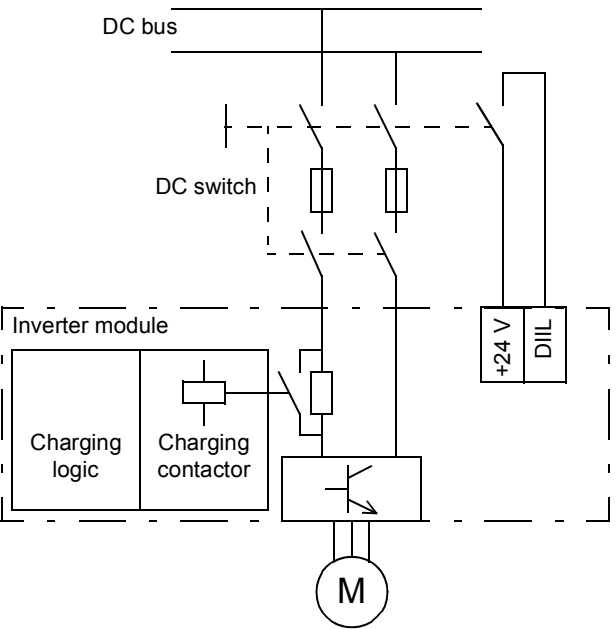
No.	Name/Value	Description	Def/Fb/Eq16
95.08	<i>DC switch monitoring</i>	<p>Enables/disables DC switch monitoring via the DIIL input. This setting is intended for use with inverter modules with an internal charging circuit that are connected to the DC bus through a DC switch.</p> <p>An auxiliary contact of the DC switch must be wired to the DIIL input so that the input switches off when the DC switch is opened.</p>  <p>If the DC switch is opened with the inverter running, the inverter is given a coast-to-stop command, and its charging circuit activated.</p> <p>Starting the inverter is prevented until the DC switch is closed and the DC circuit in the inverter unit recharged.</p> <p>Notes:</p> <ul style="list-style-type: none"> • By default, DIIL is the input for the Run enable signal. Adjust 20.12 Run enable 1 source if necessary. • An internal charging circuit is standard on some inverter module types but optional on others; check with your local ABB representative. 	<i>Disable; Enable</i> (95.20 b5)
	Disable	DC switch monitoring through the DIIL input disabled.	0
	Enable	DC switch monitoring through the DIIL input enabled.	1

No.	Name/Value	Description	Def/FbEq16															
95.15	<i>Special HW settings</i>	<p>Contains hardware-related settings that can be enabled and disabled by toggling the specific bits.</p> <p>Note: The installation of the hardware specified by this parameter may require derating of drive output, or impose other limitations. Refer to the hardware manual of the drive.</p>	-															
<table border="1"> <thead> <tr> <th>Bit</th> <th>Name</th> <th>Information</th> </tr> </thead> <tbody> <tr> <td>0</td> <td>EX motor</td> <td>1 = The drive is part of a drive/motor package provided by ABB for potentially explosive atmospheres.</td> </tr> <tr> <td>1</td> <td>Reserved</td> <td></td> </tr> <tr> <td>2</td> <td>High speed mode</td> <td>1 = Minimum switching frequency limit adaptation to output frequency active. This setting improves control performance at high output frequencies (typically above 120 Hz).</td> </tr> <tr> <td>3...15</td> <td>Reserved</td> <td></td> </tr> </tbody> </table>				Bit	Name	Information	0	EX motor	1 = The drive is part of a drive/motor package provided by ABB for potentially explosive atmospheres.	1	Reserved		2	High speed mode	1 = Minimum switching frequency limit adaptation to output frequency active. This setting improves control performance at high output frequencies (typically above 120 Hz).	3...15	Reserved	
Bit	Name	Information																
0	EX motor	1 = The drive is part of a drive/motor package provided by ABB for potentially explosive atmospheres.																
1	Reserved																	
2	High speed mode	1 = Minimum switching frequency limit adaptation to output frequency active. This setting improves control performance at high output frequencies (typically above 120 Hz).																
3...15	Reserved																	
0000b...0111b		Hardware options configuration word.	1 = 1															

No.	Name/Value	Description	Def/FbEq16																																										
95.20	<i>HW options word 1</i>	<p>Specifies hardware-related options that require differentiated parameter defaults. Activating a bit in this parameter makes the necessary changes in other parameters – for example, activating an emergency stop option reserves a digital input. In many cases, the differentiated parameters will also be write-protected.</p> <p>This parameter, as well as the changes in other parameters implemented by it, are not affected by a parameter restore.</p>	-																																										
<table border="1"> <thead> <tr> <th>Bit</th> <th>Name</th> <th>Information</th> </tr> </thead> <tbody> <tr> <td>0</td> <td>Supply frequency 60 Hz</td> <td>0 = 50 Hz; 1 = 60 Hz. Affects parameters 11.45, 11.59, 12.20, 13.18, 30.11, 30.12, 30.13, 30.14, 31.26, 31.27, 46.01, 46.02.</td> </tr> <tr> <td>1</td> <td>Emergency stop Cat 0</td> <td>1 = Emergency stop, Category 0, without FSO module. Affects parameters 21.04, 21.05, 23.11.</td> </tr> <tr> <td>2</td> <td>Emergency stop Cat 1</td> <td>1 = Emergency stop, Category 1, without FSO module. Affects parameters 10.24, 21.04, 21.05, 23.11.</td> </tr> <tr> <td>3</td> <td>RO2 for -07 cabinet cooling fan</td> <td>1 = Control of cabinet cooling fan (used only with specific ACS880-M04-07 hardware). Affects parameters 10.27, 10.28, 10.29.</td> </tr> <tr> <td>4</td> <td>Externally powered control unit</td> <td>1 = Control unit powered externally. Affects parameter 95.04.</td> </tr> <tr> <td>5</td> <td>DC supply switch</td> <td>1 = DC switch monitoring active. Affects parameters 20.12, 31.03, 95.08. Note: Setting this bit activates the Run enable signal. Recheck 20.12 and adjust if necessary.</td> </tr> <tr> <td>6</td> <td>DOL motor switch</td> <td>1 = Motor fan control active. Affects parameters 10.24, 35.100, 35.103, 35.104.</td> </tr> <tr> <td>7</td> <td colspan="2">Reserved</td> </tr> <tr> <td>8</td> <td>Service switch</td> <td>1 = Service switch connected. Affects parameters 31.01, 31.02.</td> </tr> <tr> <td>9</td> <td>Output contactor</td> <td>1 = Output contactor present. Affects parameters 10.24, 20.12.</td> </tr> <tr> <td>10...12</td> <td colspan="2">Reserved</td> </tr> <tr> <td>13</td> <td>du/dt filter activation</td> <td>1 = Active: A du/dt filter is connected to the drive/inverter output. Note: This bit is to be left at 0 if the drive/inverter module is equipped with internal du/dt filtering (for example, frame R8i inverter modules with option +E205).</td> </tr> <tr> <td>14</td> <td>DOL fan activation</td> <td>1 = The inverter unit consists of frame R8i modules with direct-on-line cooling fans (option +C188). Disables fan feedback monitoring and changes fan control to ON/OFF type.</td> </tr> </tbody> </table>				Bit	Name	Information	0	Supply frequency 60 Hz	0 = 50 Hz; 1 = 60 Hz. Affects parameters 11.45 , 11.59 , 12.20 , 13.18 , 30.11 , 30.12 , 30.13 , 30.14 , 31.26 , 31.27 , 46.01 , 46.02 .	1	Emergency stop Cat 0	1 = Emergency stop, Category 0, without FSO module. Affects parameters 21.04 , 21.05 , 23.11 .	2	Emergency stop Cat 1	1 = Emergency stop, Category 1, without FSO module. Affects parameters 10.24 , 21.04 , 21.05 , 23.11 .	3	RO2 for -07 cabinet cooling fan	1 = Control of cabinet cooling fan (used only with specific ACS880-M04-07 hardware). Affects parameters 10.27 , 10.28 , 10.29 .	4	Externally powered control unit	1 = Control unit powered externally. Affects parameter 95.04 .	5	DC supply switch	1 = DC switch monitoring active. Affects parameters 20.12 , 31.03 , 95.08 . Note: Setting this bit activates the Run enable signal. Recheck 20.12 and adjust if necessary.	6	DOL motor switch	1 = Motor fan control active. Affects parameters 10.24 , 35.100 , 35.103 , 35.104 .	7	Reserved		8	Service switch	1 = Service switch connected. Affects parameters 31.01 , 31.02 .	9	Output contactor	1 = Output contactor present. Affects parameters 10.24 , 20.12 .	10...12	Reserved		13	du/dt filter activation	1 = Active: A du/dt filter is connected to the drive/inverter output. Note: This bit is to be left at 0 if the drive/inverter module is equipped with internal du/dt filtering (for example, frame R8i inverter modules with option +E205).	14	DOL fan activation	1 = The inverter unit consists of frame R8i modules with direct-on-line cooling fans (option +C188). Disables fan feedback monitoring and changes fan control to ON/OFF type.
Bit	Name	Information																																											
0	Supply frequency 60 Hz	0 = 50 Hz; 1 = 60 Hz. Affects parameters 11.45 , 11.59 , 12.20 , 13.18 , 30.11 , 30.12 , 30.13 , 30.14 , 31.26 , 31.27 , 46.01 , 46.02 .																																											
1	Emergency stop Cat 0	1 = Emergency stop, Category 0, without FSO module. Affects parameters 21.04 , 21.05 , 23.11 .																																											
2	Emergency stop Cat 1	1 = Emergency stop, Category 1, without FSO module. Affects parameters 10.24 , 21.04 , 21.05 , 23.11 .																																											
3	RO2 for -07 cabinet cooling fan	1 = Control of cabinet cooling fan (used only with specific ACS880-M04-07 hardware). Affects parameters 10.27 , 10.28 , 10.29 .																																											
4	Externally powered control unit	1 = Control unit powered externally. Affects parameter 95.04 .																																											
5	DC supply switch	1 = DC switch monitoring active. Affects parameters 20.12 , 31.03 , 95.08 . Note: Setting this bit activates the Run enable signal. Recheck 20.12 and adjust if necessary.																																											
6	DOL motor switch	1 = Motor fan control active. Affects parameters 10.24 , 35.100 , 35.103 , 35.104 .																																											
7	Reserved																																												
8	Service switch	1 = Service switch connected. Affects parameters 31.01 , 31.02 .																																											
9	Output contactor	1 = Output contactor present. Affects parameters 10.24 , 20.12 .																																											
10...12	Reserved																																												
13	du/dt filter activation	1 = Active: A du/dt filter is connected to the drive/inverter output. Note: This bit is to be left at 0 if the drive/inverter module is equipped with internal du/dt filtering (for example, frame R8i inverter modules with option +E205).																																											
14	DOL fan activation	1 = The inverter unit consists of frame R8i modules with direct-on-line cooling fans (option +C188). Disables fan feedback monitoring and changes fan control to ON/OFF type.																																											
0000h...FFFFh		Hardware options configuration word 1.	1 = 1																																										

No.	Name/Value	Description	Def/FbEq16									
95.21	<i>HW options word 2</i>	Specifies more hardware-related options that require differentiated parameter defaults. See parameter <i>95.20 HW options word 1</i> .	-									
	<table border="1"> <thead> <tr> <th>Bit</th> <th>Name</th> <th>Information</th> </tr> </thead> <tbody> <tr> <td>0</td> <td>Dual use</td> <td>1 = Dual use active. For drives with option +N8200. (Allows higher output frequencies and frequency reference limits.)</td> </tr> <tr> <td>1...15</td> <td>Reserved</td> <td></td> </tr> </tbody> </table>	Bit	Name	Information	0	Dual use	1 = Dual use active. For drives with option +N8200. (Allows higher output frequencies and frequency reference limits.)	1...15	Reserved			
Bit	Name	Information										
0	Dual use	1 = Dual use active. For drives with option +N8200. (Allows higher output frequencies and frequency reference limits.)										
1...15	Reserved											
	0000h...FFFFh	Hardware options configuration word 2.	1 = 1									
96 System		Language selection; access levels; macro selection; parameter save and restore; control unit reboot; user parameter sets; unit selection.										
96.01	<i>Language</i>	Selects the language of the parameter interface and other displayed information when viewed on the control panel. Notes: <ul style="list-style-type: none"> • Not all languages listed below are necessarily supported. • This parameter does not affect the languages visible in the Drive composer PC tool. (Those are specified under View – Settings.) 	-									
	Not selected	None.	0									
	English	English.	1033									
	Deutsch	German.	1031									
	Italiano	Italian.	1040									
	Español	Spanish.	3082									
	Portugues	Portuguese.	2070									
	Nederlands	Dutch.	1043									
	Français	French.	1036									
	Dansk	Danish.	1030									
	Suomi	Finnish.	1035									
	Svenska	Swedish.	1053									
	Russki	Russian.	1049									
	Polski	Polish.	1045									
	Czech	Czech.	1029									
	Chinese (Simplified, PRC)	Simplified Chinese.	2052									
	Türkçe	Turkish.	1055									

No.	Name/Value	Description	Def/FbEq16																				
96.02	Pass code	Pass codes can be entered into this parameter to activate further access levels, for example additional parameters, parameter lock, etc. See parameter 96.03 Access levels active . Entering "358" toggles the parameter lock, which prevents the changing of all other parameters through the control panel or the Drive composer PC tool.	0																				
	0...99999999	Pass code.	-																				
96.03	Access levels active	Shows which access levels have been activated by pass codes entered into parameter 96.02 Pass code . This parameter is read-only.	0001h																				
<table border="1"> <thead> <tr> <th>Bit</th> <th>Name</th> </tr> </thead> <tbody> <tr> <td>0</td> <td>End user</td> </tr> <tr> <td>1</td> <td>Service</td> </tr> <tr> <td>2</td> <td>Advanced programmer</td> </tr> <tr> <td>3...10</td> <td>Reserved</td> </tr> <tr> <td>11</td> <td>OEM access level 1</td> </tr> <tr> <td>12</td> <td>OEM access level 2</td> </tr> <tr> <td>13</td> <td>OEM access level 3</td> </tr> <tr> <td>14</td> <td>Parameter lock</td> </tr> <tr> <td>15</td> <td>Reserved</td> </tr> </tbody> </table>				Bit	Name	0	End user	1	Service	2	Advanced programmer	3...10	Reserved	11	OEM access level 1	12	OEM access level 2	13	OEM access level 3	14	Parameter lock	15	Reserved
Bit	Name																						
0	End user																						
1	Service																						
2	Advanced programmer																						
3...10	Reserved																						
11	OEM access level 1																						
12	OEM access level 2																						
13	OEM access level 3																						
14	Parameter lock																						
15	Reserved																						
	0000h...FFFFh	Active access levels.	-																				
96.04	Macro select	Selects the application macro. See chapter Application macros (page 85) for more information. After a selection is made, the parameter reverts automatically to Done .	Done																				
	Done	Macro selection complete; normal operation.	0																				
	Factory	Factory macro (see page 86).	1																				
	Sequence control	Sequential control macro (see page 88).	5																				
	FIELDDBUS	Reserved.	6																				
96.05	Macro active	Shows which application macro is currently selected. See chapter Application macros (page 85) for more information. To change the macro, use parameter 96.04 Macro select .	Factory																				
	Factory	Factory macro (see page 86).	1																				
	FIELDDBUS	Fieldbus control macro (see page 88).	6																				

412 Parameters

No.	Name/Value	Description	Def/FbEq16
96.06	<i>Parameter restore</i>	Restores the original settings of the control program, ie. parameter default values. Note: This parameter cannot be changed while the drive is running.	<i>Done</i>
	Done	Restoring is completed.	0
	Restore defaults	All editable parameter values are restored to default values, except <ul style="list-style-type: none"> • motor data and ID run results • parameter <i>31.42 Overcurrent fault limit</i> • control panel/PC communication settings • I/O extension module settings • fieldbus adapter settings • encoder configuration data • application macro selection and the parameter defaults implemented by it • parameter <i>95.01 Supply voltage</i> • parameter <i>95.20 HW options word 1</i> and the differentiated defaults implemented by it. 	8
	Clear all	All editable parameter values are restored to default values, except <ul style="list-style-type: none"> • control panel/PC communication settings • fieldbus adapter settings • application macro selection and the parameter defaults implemented by it • parameter <i>95.01 Supply voltage</i> • parameter <i>95.20 HW options word 1</i> and the differentiated defaults implemented by it. PC tool communication is interrupted during the restoring.	62
96.07	<i>Parameter save manually</i>	Saves the valid parameter values to permanent memory. This parameter should be used to store values sent from a fieldbus, or when using an external power supply to the control board as the supply might have a very short hold-up time when powered off. Note: A new parameter value is saved automatically when changed from the PC tool or control panel but not when altered through a fieldbus adapter connection.	<i>Done</i>
	Done	Save completed.	0
	Save	Save in progress.	1
96.08	<i>Control board boot</i>	Changing the value of this parameter to 1 reboots the control unit (without requiring a power off/on cycle of the complete drive module). The value reverts to 0 automatically.	0
	0...1	1 = Reboot the control unit.	1 = 1

No.	Name/Value	Description	Def/FbEq16
96.09	<i>FSO reboot</i>	Changing the value of (or the source selected by) this parameter from 0 to 1 reboots the optional FSO-xx safety functions module. Note: The value does not revert to 0 automatically.	<i>False</i>
	False	0.	0
	True	1.	1
	<i>Other [bit]</i>	Source selection (see <i>Terms and abbreviations</i> on page 90).	-
96.10	<i>User set status</i>	Shows the status of the user parameter sets. This parameter is read-only. See also section <i>User parameter sets</i> (page 82).	-
	n/a	No user parameter sets have been saved.	0
	Loading	A user set is being loaded.	1
	Saving	A user set is being saved.	2
	Faulted	Invalid or empty parameter set.	3
	User set 1	User set 1 has been loaded.	4
	User set 2	User set 2 has been loaded.	5
	User set 3	User set 3 has been loaded.	6
	User set 4	User set 4 has been loaded.	7
96.11	<i>User set save/load</i>	Enables the saving and restoring of up to four custom sets of parameter settings. See section <i>User parameter sets</i> (page 82). The set that was in use before powering down the drive is in use after the next power-up. Notes: <ul style="list-style-type: none"> Hardware configuration settings such as I/O extension module, fieldbus and encoder configuration parameters (groups 14...16, 47, 51...56, 58 and 92...93), and forced input/output values (such as <i>10.03</i> and <i>10.04</i>) are not included in user parameter sets. Parameter changes made after loading a set are not automatically stored – they must be saved using this parameter. 	<i>No action</i>
	No action	Load or save operation complete; normal operation.	0
	User set I/O mode	Load user parameter set using parameters <i>96.12 User set I/O mode in1</i> and <i>96.13 User set I/O mode in2</i> .	1
	Load set 1	Load user parameter set 1.	2
	Load set 2	Load user parameter set 2.	3
	Load set 3	Load user parameter set 3.	4

No.	Name/Value	Description	Def/FbEq16															
	Load set 4	Load user parameter set 4.	5															
	Save to set 1	Save user parameter set 1.	18															
	Save to set 2	Save user parameter set 2.	19															
	Save to set 3	Save user parameter set 3.	20															
	Save to set 4	Save user parameter set 4.	21															
96.12	<i>User set I/O mode in1</i>	When parameter <i>96.11 User set save/load</i> is set to <i>User set I/O mode</i> , selects the user parameter set together with parameter <i>96.13 User set I/O mode in2</i> as follows: <table border="1" data-bbox="498 663 1165 1039"> <thead> <tr> <th>Status of source defined by par. 96.12</th> <th>Status of source defined by par. 96.13</th> <th>User parameter set selected</th> </tr> </thead> <tbody> <tr> <td>0</td> <td>0</td> <td>Set 1</td> </tr> <tr> <td>1</td> <td>0</td> <td>Set 2</td> </tr> <tr> <td>0</td> <td>1</td> <td>Set 3</td> </tr> <tr> <td>1</td> <td>1</td> <td>Set 4</td> </tr> </tbody> </table>	Status of source defined by par. 96.12	Status of source defined by par. 96.13	User parameter set selected	0	0	Set 1	1	0	Set 2	0	1	Set 3	1	1	Set 4	<i>Not selected</i>
Status of source defined by par. 96.12	Status of source defined by par. 96.13	User parameter set selected																
0	0	Set 1																
1	0	Set 2																
0	1	Set 3																
1	1	Set 4																
	Not selected	0.	0															
	Selected	1.	1															
	DI1	Digital input DI1 (<i>10.02 DI delayed status</i> , bit 0).	2															
	DI2	Digital input DI2 (<i>10.02 DI delayed status</i> , bit 1).	3															
	DI3	Digital input DI3 (<i>10.02 DI delayed status</i> , bit 2).	4															
	DI4	Digital input DI4 (<i>10.02 DI delayed status</i> , bit 3).	5															
	DI5	Digital input DI5 (<i>10.02 DI delayed status</i> , bit 4).	6															
	DI6	Digital input DI6 (<i>10.02 DI delayed status</i> , bit 5).	7															
	DIO1	Digital input/output DIO1 (<i>11.02 DIO delayed status</i> , bit 0).	10															
	DIO2	Digital input/output DIO2 (<i>11.02 DIO delayed status</i> , bit 1).	11															
	<i>Other [bit]</i>	Source selection (see <i>Terms and abbreviations</i> on page 90).	-															
96.13	<i>User set I/O mode in2</i>	See parameter <i>96.12 User set I/O mode in1</i> .	<i>Not selected</i>															

No.	Name/Value	Description	Def/FbEq16																					
96.16	<i>Unit selection</i>	Selects the unit of parameters indicating power, temperature and torque.	0000 0000b																					
		<table border="1"> <thead> <tr> <th>Bit</th> <th>Name</th> <th>Information</th> </tr> </thead> <tbody> <tr> <td>0</td> <td>Power unit</td> <td>0 = kW 1 = hp</td> </tr> <tr> <td>1</td> <td>Reserved</td> <td></td> </tr> <tr> <td>2</td> <td>Temperature unit</td> <td>0 = C (°C) 1 = F (°F)</td> </tr> <tr> <td>3</td> <td>Reserved</td> <td></td> </tr> <tr> <td>4</td> <td>Torque unit</td> <td>0 = Nm (N·m) 1 = lbft (lb·ft)</td> </tr> <tr> <td>5...15</td> <td>Reserved</td> <td></td> </tr> </tbody> </table>	Bit	Name	Information	0	Power unit	0 = kW 1 = hp	1	Reserved		2	Temperature unit	0 = C (°C) 1 = F (°F)	3	Reserved		4	Torque unit	0 = Nm (N·m) 1 = lbft (lb·ft)	5...15	Reserved		
Bit	Name	Information																						
0	Power unit	0 = kW 1 = hp																						
1	Reserved																							
2	Temperature unit	0 = C (°C) 1 = F (°F)																						
3	Reserved																							
4	Torque unit	0 = Nm (N·m) 1 = lbft (lb·ft)																						
5...15	Reserved																							
	0000 0000b ... 0001 0101b	Unit selection word.	1 = 1																					
96.20	<i>Time sync primary source</i>	Defines the 1st priority external source for synchronization of the drive's time and date.	<i>Internal</i>																					
	Internal	No external source selected.	0																					
	Fieldbus A or B	Fieldbus interface A or B.	2																					
	Fieldbus A	Fieldbus interface A.	3																					
	Fieldbus B	Fieldbus interface B.	4																					
	D2D or M/F	The master station on a master/follower or drive-to-drive link.	5																					
	Embedded FB	Embedded fieldbus interface.	6																					
	Panel link	Control panel, or Drive composer PC tool connected to the control panel.	8																					
	Ethernet tool link	Drive composer PC tool through an FENA module.	9																					
96.23	<i>M/F and D2D clock synchronization</i>	In the master drive, activates clock synchronization for master/follower and drive-to-drive communication.	<i>Inactive</i>																					
	Inactive	Clock synchronization not active.	0																					
	Active	Clock synchronization active.	1																					

No.	Name/Value	Description	Def/FbEq16
96.24	<i>Full days since 1st Jan 1980</i>	Number of full days passed since beginning of the year 1980. This parameter, together with <i>96.25 Time in minutes within 24 h</i> and <i>96.26 Time in ms within one minute</i> makes it possible to set the date and time in the drive via the parameter interface from a fieldbus or application program. This may be necessary if the fieldbus protocol does not support time synchronization.	-
	1...59999	Days since beginning of 1980.	1 = 1
96.25	<i>Time in minutes within 24 h</i>	Number of full minutes passed since midnight. For example, the value 860 corresponds to 2:20 pm. See parameter <i>96.24 Full days since 1st Jan 1980</i> .	0 min
	1...1439	Minutes since midnight.	1 = 1
96.26	<i>Time in ms within one minute</i>	Number of milliseconds passed since last minute. See parameter <i>96.24 Full days since 1st Jan 1980</i> .	0 ms
	0...59999	Number of milliseconds since last minute.	1 = 1

No.	Name/Value	Description	Def/FbEq16																																																
96.29	<i>Time sync source status</i>	Time source status word. This parameter is read-only.	-																																																
		<table border="1"> <thead> <tr> <th>Bit</th> <th>Name</th> <th>Description</th> </tr> </thead> <tbody> <tr> <td>0</td> <td>Time tick received</td> <td>1 = 1st priority tick received: Tick has been received from 1st priority source.</td> </tr> <tr> <td>1</td> <td>Aux Time tick received</td> <td>1 = 2nd priority tick received: Tick has been received from 2nd priority source.</td> </tr> <tr> <td>2</td> <td>Tick interval is too long</td> <td>1 = Yes: Tick interval too long (accuracy compromised).</td> </tr> <tr> <td>3</td> <td>Reserved</td> <td></td> </tr> <tr> <td>4</td> <td>Master/Follower</td> <td>1 = Tick received: Tick has been received through the master/follower link.</td> </tr> <tr> <td>5</td> <td>Reserved</td> <td></td> </tr> <tr> <td>6</td> <td>D2D</td> <td>1 = Tick received: Tick has been received through the drive-to-drive link.</td> </tr> <tr> <td>7</td> <td>FbusA</td> <td>1 = Tick received: Tick has been received through fieldbus interface A.</td> </tr> <tr> <td>8</td> <td>FbusB</td> <td>1 = Tick received: Tick has been received through fieldbus interface B.</td> </tr> <tr> <td>9</td> <td>EFB</td> <td>1 = Tick received: Tick has been received through the embedded fieldbus interface.</td> </tr> <tr> <td>11</td> <td>Panel link</td> <td>1 = Tick received: Tick has been received from the control panel, or Drive composer PC tool connected to the control panel.</td> </tr> <tr> <td>12</td> <td>Ethernet tool link</td> <td>1 = Tick received: Tick has been received from Drive composer PC tool through an FENA module.</td> </tr> <tr> <td>13</td> <td>Parameter setting</td> <td>1 = Tick received: Tick has been set by parameters 96.24...96.26.</td> </tr> <tr> <td>14</td> <td>RTC</td> <td>1 = RTC time in use: Time and date have been read from the real-time clock.</td> </tr> <tr> <td>15</td> <td>Drive On-Time</td> <td>1 = Drive on-time in use: Time and date are displaying drive on-time.</td> </tr> </tbody> </table>	Bit	Name	Description	0	Time tick received	1 = 1st priority tick received: Tick has been received from 1st priority source.	1	Aux Time tick received	1 = 2nd priority tick received: Tick has been received from 2nd priority source.	2	Tick interval is too long	1 = Yes: Tick interval too long (accuracy compromised).	3	Reserved		4	Master/Follower	1 = Tick received: Tick has been received through the master/follower link.	5	Reserved		6	D2D	1 = Tick received: Tick has been received through the drive-to-drive link.	7	FbusA	1 = Tick received: Tick has been received through fieldbus interface A.	8	FbusB	1 = Tick received: Tick has been received through fieldbus interface B.	9	EFB	1 = Tick received: Tick has been received through the embedded fieldbus interface.	11	Panel link	1 = Tick received: Tick has been received from the control panel, or Drive composer PC tool connected to the control panel.	12	Ethernet tool link	1 = Tick received: Tick has been received from Drive composer PC tool through an FENA module.	13	Parameter setting	1 = Tick received: Tick has been set by parameters 96.24 ... 96.26 .	14	RTC	1 = RTC time in use: Time and date have been read from the real-time clock.	15	Drive On-Time	1 = Drive on-time in use: Time and date are displaying drive on-time.	
Bit	Name	Description																																																	
0	Time tick received	1 = 1st priority tick received: Tick has been received from 1st priority source.																																																	
1	Aux Time tick received	1 = 2nd priority tick received: Tick has been received from 2nd priority source.																																																	
2	Tick interval is too long	1 = Yes: Tick interval too long (accuracy compromised).																																																	
3	Reserved																																																		
4	Master/Follower	1 = Tick received: Tick has been received through the master/follower link.																																																	
5	Reserved																																																		
6	D2D	1 = Tick received: Tick has been received through the drive-to-drive link.																																																	
7	FbusA	1 = Tick received: Tick has been received through fieldbus interface A.																																																	
8	FbusB	1 = Tick received: Tick has been received through fieldbus interface B.																																																	
9	EFB	1 = Tick received: Tick has been received through the embedded fieldbus interface.																																																	
11	Panel link	1 = Tick received: Tick has been received from the control panel, or Drive composer PC tool connected to the control panel.																																																	
12	Ethernet tool link	1 = Tick received: Tick has been received from Drive composer PC tool through an FENA module.																																																	
13	Parameter setting	1 = Tick received: Tick has been set by parameters 96.24 ... 96.26 .																																																	
14	RTC	1 = RTC time in use: Time and date have been read from the real-time clock.																																																	
15	Drive On-Time	1 = Drive on-time in use: Time and date are displaying drive on-time.																																																	
	0000h...FFFFh	Time source status word 1.	1 = 1																																																
96.31	<i>Drive ID number</i>	Specifies an ID number for the drive. The ID can be read by an external controller through DDCS, for example, for comparison with an ID contained by the controller's application.	0																																																
	0...32767	ID number.	1 = 1																																																

No.	Name/Value	Description	Def/FbEq16																		
96.61	<i>User data logger status word</i>	Provides status information on the user data logger (see page 481).	0000b																		
		<table border="1"> <thead> <tr> <th>Bit</th> <th>Name</th> <th>Description</th> </tr> </thead> <tbody> <tr> <td>0</td> <td>Running</td> <td>1 = The user data logger is running. The bit is cleared after the post-trigger time has passed.</td> </tr> <tr> <td>1</td> <td>Triggered</td> <td>1 = The user data logger has been triggered. The bit is cleared when the logger is restarted.</td> </tr> <tr> <td>2</td> <td>Data available</td> <td>1 = The user data logger contains data that can be read. Note that the bit is not cleared because the data is saved to the memory unit.</td> </tr> <tr> <td>3</td> <td>Configured</td> <td>1 = The user data logger has been configured. Note that the bit is not cleared because the configuration data is saved to the memory unit.</td> </tr> <tr> <td>4...15</td> <td>Reserved</td> <td></td> </tr> </tbody> </table>	Bit	Name	Description	0	Running	1 = The user data logger is running. The bit is cleared after the post-trigger time has passed.	1	Triggered	1 = The user data logger has been triggered. The bit is cleared when the logger is restarted.	2	Data available	1 = The user data logger contains data that can be read. Note that the bit is not cleared because the data is saved to the memory unit.	3	Configured	1 = The user data logger has been configured. Note that the bit is not cleared because the configuration data is saved to the memory unit.	4...15	Reserved		
Bit	Name	Description																			
0	Running	1 = The user data logger is running. The bit is cleared after the post-trigger time has passed.																			
1	Triggered	1 = The user data logger has been triggered. The bit is cleared when the logger is restarted.																			
2	Data available	1 = The user data logger contains data that can be read. Note that the bit is not cleared because the data is saved to the memory unit.																			
3	Configured	1 = The user data logger has been configured. Note that the bit is not cleared because the configuration data is saved to the memory unit.																			
4...15	Reserved																				
	0000b...1111b	User data logger status word.	1 = 1																		
96.63	<i>User data logger trigger</i>	Triggers, or selects a source that triggers, the user data logger.	<i>Off</i>																		
	Off	0.	0																		
	On	1.	1																		
	<i>Other [bit]</i>	Source selection (see <i>Terms and abbreviations</i> on page 90).	-																		
96.64	<i>User data logger start</i>	Starts, or selects a source that starts, the user data logger.	<i>Off</i>																		
	Off	0.	0																		
	On	1.	1																		
	<i>Other [bit]</i>	Source selection (see <i>Terms and abbreviations</i> on page 90).	-																		
96.65	<i>Factory data logger time level</i>	Selects the sampling interval for the factory data logger (see page 480).	<i>500us</i>																		
	500us	500 microseconds.	500																		
	2ms	2 milliseconds.	2000																		
	10ms	10 milliseconds.	10000																		

No.	Name/Value	Description	Def/FbEq16
97 Motor control			
97.03	<i>Slip gain</i>	<p>Defines the slip gain which is used to improve the estimated motor slip. 100% means full slip gain; 0% means no slip gain. The default value is 100%. Other values can be used if a static speed error is detected despite having the setting at full slip gain.</p> <p>Example (with nominal load and nominal slip of 40 rpm): A 1000 rpm constant speed reference is given to the drive. Despite having full slip gain (= 100%), a manual tachometer measurement from the motor axis gives a speed value of 998 rpm. The static speed error is 1000 rpm - 998 rpm = 2 rpm. To compensate the error, the slip gain should be increased to 105% (2 rpm / 40 rpm = 5%).</p>	100%
0 ... 200%		Slip gain.	1 = 1%
97.04	<i>Voltage reserve</i>	<p>Defines the minimum allowed voltage reserve. When the voltage reserve has decreased to the set value, the drive enters the field weakening area.</p> <p>Note: This is an expert level parameter and should not be adjusted without appropriate skill.</p> <p>If the intermediate circuit DC voltage $U_{dc} = 550 \text{ V}$ and the voltage reserve is 5%, the RMS value of the maximum output voltage in steady-state operation is</p> $0.95 \times 550 \text{ V} / \sqrt{2} = 369 \text{ V}$ <p>The dynamic performance of the motor control in the field weakening area can be improved by increasing the voltage reserve value, but the drive enters the field weakening area earlier.</p>	-2%
-4 ... 50%		Voltage reserve.	1 = 1%
97.05	<i>Flux braking</i>	<p>Defines the level of flux braking power. (Other stopping and braking modes can be configured in parameter group 21 Start/stop mode).</p> <p>See section Flux braking (page 63).</p> <p>Note: This is an expert level parameter and should not be adjusted without appropriate skill.</p>	<i>Disabled</i>
Disabled		Flux braking is disabled.	0
Moderate		Flux level is limited during the braking. Deceleration time is longer compared to full braking.	1
Full		Maximum braking power. Almost all available current is used to convert the mechanical braking energy to thermal energy in the motor.	2

No.	Name/Value	Description	Def/FbEq16
97.06	<i>Flux reference select</i>	Defines the source of flux reference. Note: This is an expert level parameter and should not be adjusted without appropriate skill.	<i>User flux reference</i>
	Zero	None.	0
	User flux reference	Parameter <i>97.07 User flux reference</i> .	1
	<i>Other</i>	Source selection (see <i>Terms and abbreviations</i> on page 90).	-
97.07	<i>User flux reference</i>	Defines the flux reference when parameter <i>97.06 Flux reference select</i> is set to <i>User flux reference</i> .	100.00%
	0.00 ... 200.00%	User-defined flux reference.	100 = 1%
97.09	<i>Switching freq mode</i>	An optimization setting for balancing between control performance and motor noise level. Note: This is an expert level parameter and should not be adjusted without appropriate skill.	<i>Normal</i>
	Normal	Control performance optimized for long motor cables.	0
	Low noise	Minimizes motor noise. Note: This setting requires derating. Refer to the rating data in the <i>Hardware manual</i> .	1
	Cyclic	Control performance optimized for cyclic load applications. Note: This setting is not suitable for long motor cables.	2
	Custom	This setting is to be used by ABB-authorized service personnel only. Note: This setting may require derating. Refer to the rating data in the <i>Hardware manual</i> .	3
97.10	<i>Signal injection</i>	Enables the anti-cogging function: a high-frequency alternating signal is injected to the motor in the low speed region to improve the stability of torque control. This removes the "cogging" that can sometimes be seen as the rotor passes the motor magnetic poles. Anti-cogging can be enabled with different amplitude levels. Notes: <ul style="list-style-type: none"> This is an expert level parameter and should not be adjusted without appropriate skill. Use as low a level as possible that gives satisfactory performance. Signal injection cannot be applied to asynchronous motors. 	<i>Disabled</i>
	Disabled	Anti-cogging disabled.	0

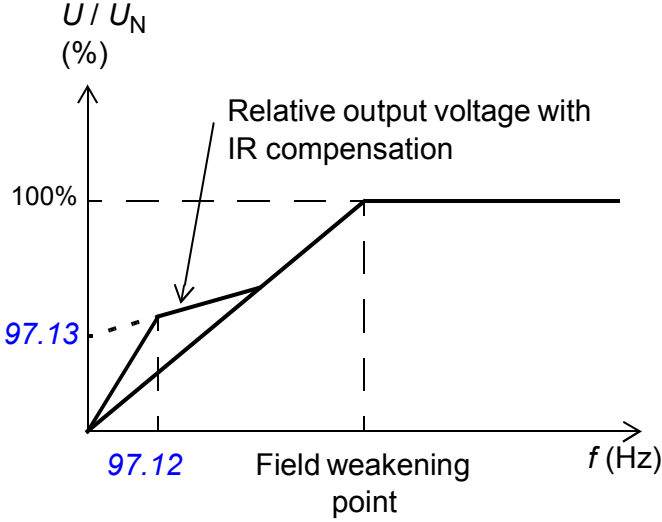
No.	Name/Value	Description	Def/FbEq16
	Enabled (5 %)	Anti-cogging enabled with amplitude level of 5%.	1
	Enabled (10 %)	Anti-cogging enabled with amplitude level of 10%.	2
	Enabled (15 %)	Anti-cogging enabled with amplitude level of 15%.	3
	Enabled (20 %)	Anti-cogging enabled with amplitude level of 20%.	4
97.11	<i>TR tuning</i>	<p>Rotor time constant tuning.</p> <p>This parameter can be used to improve torque accuracy in closed-loop control of an induction motor. Normally, the motor identification run provides sufficient torque accuracy, but manual fine-tuning can be applied in exceptionally demanding applications to achieve optimal performance.</p> <p>Note: This is an expert level parameter and should not be adjusted without appropriate skill.</p>	100%
	25...400%	Rotor time constant tuning.	1 = 1%
97.12	<i>IR comp step-up frequency</i>	<p>IR compensation (ie. output voltage boost) can be used in step-up applications to compensate for resistive losses in the step-up transformer, cabling and motor. As voltage cannot be fed through a step-up transformer at 0 Hz, a specific type of IR compensation should be used.</p> <p>This parameter adds a frequency breakpoint for parameter 97.13 IR compensation as shown below.</p>  <p>0.0 Hz = Breakpoint disabled.</p>	0.0 Hz
	0.0 ... 50.0 Hz	IR compensation breakpoint for step-up applications.	1 = 1 Hz

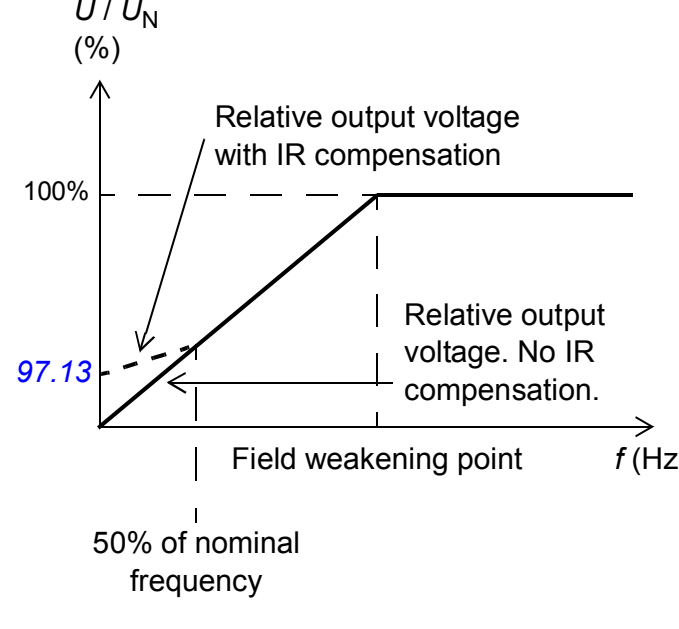
No.	Name/Value	Description	Def/FbEq16
97.13	<i>IR compensation</i>	<p>Defines the relative output voltage boost at zero speed (IR compensation). The function is useful in applications with a high break-away torque where direct torque control (DTC mode) cannot be applied.</p>  <p>See also section <i>IR compensation for scalar motor control</i> on page 60.</p>	0.00%
0.00 ... 50.00%		Voltage boost at zero speed in percent of nominal motor voltage.	1 = 1%
97.15	<i>Motor model temperature adaptation</i>	<p>Selects whether the temperature-dependent parameters (such as stator or rotor resistance) of the motor model adapt to actual (measured or estimated) temperature or not.</p> <p>See parameter group <i>35 Motor thermal protection</i> for selection of temperature measurement sources.</p>	<i>Disabled</i>
Disabled		Temperature adaptation of motor model disabled.	0
Estimated temperature		Estimated temperature (<i>35.01 Motor estimated temperature</i>) used for adaptation of motor model.	1
Measured temperature 1		Measured temperature 1 (<i>35.02 Measured temperature 1</i>) used for adaptation of motor model.	2
Measured temperature 2		Measured temperature 2 (<i>35.03 Measured temperature 2</i>) used for adaptation of motor model.	3
97.32	<i>Motor torque unfiltered</i>	Unfiltered motor torque in percent of the nominal motor torque.	-
-1600.0 ... 1600.0%		Unfiltered motor torque.	See par. <i>46.03</i>

No.	Name/Value	Description	Def/FbEq16
97.33	<i>Speed estimate filter time</i>	Defines a filtering time for estimated speed. See the diagram on page 569.	5.00 ms
	0.00 ... 100.00 ms	Filtering time for estimated speed.	1 = 1 ms
98 User motor parameters		Motor values supplied by the user that are used in the motor model. These parameters are useful for non-standard motors, or to just get more accurate motor control of the motor on site. A better motor model always improves the shaft performance.	
98.01	<i>User motor model mode</i>	Activates the motor model parameters 98.02...98.14 and the rotor angle offset parameter 98.15. Notes: <ul style="list-style-type: none"> Parameter value is automatically set to zero when ID run is selected by parameter 99.13 <i>ID run requested</i>. The values of parameters 98.02...98.15 are then updated according to the motor characteristics identified during the ID run. Measurements made directly from the motor terminals during the ID run are likely to produce slightly different values than those on a datasheet from a motor manufacturer. This parameter cannot be changed while the drive is running. 	<i>Not selected</i>
	Not selected	Parameters 98.02...98.15 inactive.	0
	Motor parameters	The values of parameters 98.02...98.14 are used as the motor model.	1
	Position offset	The value of parameter 98.15 is used as the rotor angle offset. Parameters 98.02...98.14 are inactive.	2
	Motor parameters & position offset	The values of parameters 98.02...98.14 are used as the motor model, and the value of parameter 98.15 is used as the rotor angle offset.	3
98.02	<i>Rs user</i>	Defines the stator resistance R_S of the motor model. With a star-connected motor, R_S is the resistance of one winding. With a delta-connected motor, R_S is one-third of the resistance of one winding.	0.00000 p.u.
	0.00000 ... 0.50000 p.u.	Stator resistance in per unit.	-

No.	Name/Value	Description	Def/FbEq16
98.03	<i>Rr user</i>	Defines the rotor resistance R_R of the motor model. Note: This parameter is valid only for asynchronous motors.	0.00000 p.u.
	0.00000 ... 0.50000 p.u.	Rotor resistance in per unit.	-
98.04	<i>Lm user</i>	Defines the main inductance L_M of the motor model. Note: This parameter is valid only for asynchronous motors.	0.00000 p.u.
	0.00000 ... 10.00000 p.u.	Main inductance in per unit.	-
98.05	<i>SigmaL user</i>	Defines the leakage inductance σL_S . Note: This parameter is valid only for asynchronous motors.	0.00000 p.u.
	0.00000 ... 1.00000 p.u.	Leakage inductance in per unit.	-
98.06	<i>Ld user</i>	Defines the direct axis (synchronous) inductance. Note: This parameter is valid only for permanent magnet motors.	0.00000 p.u.
	0.00000 ... 10.00000 p.u	Direct axis inductance in per unit.	-
98.07	<i>Lq user</i>	Defines the quadrature axis (synchronous) inductance. Note: This parameter is valid only for permanent magnet motors.	0.00000 p.u.
	0.00000 ... 10.00000 p.u	Quadrature axis inductance in per unit.	-
98.08	<i>PM flux user</i>	Defines the permanent magnet flux. Note: This parameter is valid only for permanent magnet motors.	0.00000 p.u.
	0.00000 ... 2.00000 p.u	Permanent magnet flux in per unit.	-
98.09	<i>Rs user SI</i>	Defines the stator resistance R_S of the motor model.	0.00000 ohm
	0.00000 ... 100.00000 ohm	Stator resistance.	-
98.10	<i>Rr user SI</i>	Defines the rotor resistance R_R of the motor model. Note: This parameter is valid only for asynchronous motors.	0.00000 ohm
	0.00000 ... 100.00000 ohm	Rotor resistance.	-



No.	Name/Value	Description	Def/FbEq16
98.11	<i>L_m user SI</i>	Defines the main inductance L_M of the motor model. Note: This parameter is valid only for asynchronous motors.	0.00 mH
	0.00 ... 100000.00 mH	Main inductance.	1 = 10000 mH
98.12	<i>SigmaL user SI</i>	Defines the leakage inductance σL_S . Note: This parameter is valid only for asynchronous motors.	0.00 mH
	0.00 ... 100000.00 mH	Leakage inductance.	1 = 10000 mH
98.13	<i>L_d user SI</i>	Defines the direct axis (synchronous) inductance. Note: This parameter is valid only for permanent magnet motors.	0.00 mH
	0.00 ... 100000.00 mH	Direct axis inductance.	1 = 10000 mH
98.14	<i>L_q user SI</i>	Defines the quadrature axis (synchronous) inductance. Note: This parameter is valid only for permanent magnet motors.	0.00 mH
	0.00 ... 100000.00 mH	Quadrature axis inductance.	1 = 10000 mH
98.15	<i>Position offset user</i>	Defines an angle offset between the zero position of the synchronous motor and the zero position of the position sensor. This value is initially set by the autophasing routine when parameter <i>21.13 Autophasing mode</i> is set to <i>Turning with Z-pulse</i> , and can be fine-tuned later on. Notes: <ul style="list-style-type: none"> The value is in electrical degrees. The electrical angle equals the mechanical angle multiplied by the number of motor pole pairs. This parameter is valid only for permanent magnet motors. 	0 deg
	0...360 deg	Angle offset.	1 = 1 deg
99 Motor data		Motor configuration settings.	
99.03	<i>Motor type</i>	Selects the motor type. Note: This parameter cannot be changed while the drive is running.	<i>Asynchronous motor</i>
	Asynchronous motor	Standard squirrel cage AC induction motor (asynchronous induction motor).	0

No.	Name/Value	Description	Def/FbEq16
	Permanent magnet motor	Permanent magnet motor. Three-phase AC synchronous motor with permanent magnet rotor and sinusoidal BackEMF voltage.	1
	SynRM	<i>(Only visible with option +N7502)</i> Synchronous reluctance motor. Three-phase AC synchronous motor with salient pole rotor without permanent magnets.	2
99.04	<i>Motor control mode</i>	Selects the motor control mode.	<i>DTC</i>
	DTC	Direct torque control. This mode is suitable for most applications. Note: Instead of direct torque control, scalar control is also available, and should be used in the following situations: <ul style="list-style-type: none"> • with multimotor applications 1) if the load is not equally shared between the motors, 2) if the motors are of different sizes, or 3) if the motors are going to be changed after the motor identification (ID run) • if the nominal current of the motor is less than 1/6 of the nominal output current of the drive • if the drive is used with no motor connected (for example, for test purposes). See also section <i>Operating modes of the drive</i> (page 28).	0
	Scalar	Scalar control. The outstanding motor control accuracy of DTC cannot be achieved in scalar control. Refer to the <i>DTC</i> selection above for a list of applications where scalar control should definitely be used. Notes: <ul style="list-style-type: none"> • Correct motor operation requires that the magnetizing current of the motor does not exceed 90% of the nominal current of the inverter. • Some standard features are disabled in scalar control mode. See also section <i>Scalar motor control</i> (page 59), and section <i>Operating modes of the drive</i> (page 28).	1

No.	Name/Value	Description	Def/FbEq16
99.06	<i>Motor nominal current</i>	<p>Defines the nominal motor current. Must be equal to the value on the motor rating plate. If multiple motors are connected to the drive, enter the total current of the motors.</p> <p>Notes:</p> <ul style="list-style-type: none"> • Correct motor operation requires that the magnetizing current of the motor does not exceed 90% of the nominal current of the drive. • This parameter cannot be changed while the drive is running. 	0.0 A
	0.0 ... 32767.0 A	Nominal current of the motor. The allowable range is $1/6 \dots 2 \times I_N$ (nominal current) of the drive ($0 \dots 2 \times I_N$ with scalar control mode).	1 = 1 A
99.07	<i>Motor nominal voltage</i>	<p>Defines the nominal motor voltage supplied to the motor. This setting must match the value on the rating plate of the motor.</p> <p>Notes:</p> <ul style="list-style-type: none"> • With permanent magnet motors, the nominal voltage is the BackEMF voltage at nominal speed of the motor. If the voltage is given as voltage per rpm, e.g. 60 V per 1000 rpm, the voltage for a nominal speed of 3000 rpm is $3 \times 60 \text{ V} = 180 \text{ V}$. Note that the nominal voltage is not equal to the equivalent DC motor voltage (EDCM) specified by some motor manufacturers. The nominal voltage can be calculated by dividing the EDCM voltage by 1.7 (or square root of 3). • The stress on the motor insulation is always dependent on the drive supply voltage. This also applies to the case where the motor voltage rating is lower than that of the drive and the supply. • This parameter cannot be changed while the drive is running. 	0.0 V
	0.0 ... 32767.0 V	Nominal voltage of the motor. The allowable range is $1/6 \dots 2 \times U_N$ (nominal voltage) of the drive. U_N equals the upper bound of the supply voltage range selected by parameter 95.01 Supply voltage .	10 = 1 V
99.08	<i>Motor nominal frequency</i>	<p>Defines the nominal motor frequency. This setting must match the value on the rating plate of the motor.</p> <p>Note: This parameter cannot be changed while the drive is running.</p>	50.00 Hz
	0.00 ... 500.00 Hz	Nominal frequency of the motor.	10 = 1 Hz

No.	Name/Value	Description	Def/FbEq16
99.09	<i>Motor nominal speed</i>	Defines the nominal motor speed. The setting must match the value on the rating plate of the motor. Note: This parameter cannot be changed while the drive is running.	0 rpm
	0 ... 30000 rpm	Nominal speed of the motor.	1 = 1 rpm
99.10	<i>Motor nominal power</i>	Defines the nominal motor power. The setting must match the value on the rating plate of the motor. If nominal power is not shown on the rating plate, nominal torque can be entered instead in parameter 99.12. If multiple motors are connected to the drive, enter the total power of the motors. The unit is selected by parameter 96.16 <i>Unit selection</i> . Note: This parameter cannot be changed while the drive is running.	0.00 kW or hp
	0.00 ... 10000.00 kW or 0.00 ... 13404.83 hp	Nominal power of the motor.	1 = 1 unit
99.11	<i>Motor nominal cos ϕ</i>	Defines the cosphi of the motor for a more accurate motor model. The value is not obligatory, but is useful with an asynchronous motor, especially when performing a standstill identification run. The setting should match the value on the rating plate of the motor. With a permanent magnet or synchronous reluctance motor, this value is not needed. Note: This parameter cannot be changed while the drive is running.	0.00
	0.00 ... 1.00	Cosphi of the motor.	100 = 1
99.12	<i>Motor nominal torque</i>	Defines the nominal motor shaft torque. This value can be given instead of nominal power (99.10) if shown on the rating plate of the motor. The unit is selected by parameter 96.16 <i>Unit selection</i> . Notes: <ul style="list-style-type: none"> This setting is an alternative to the nominal power value (99.10). If both are entered, 99.12 takes priority. This parameter cannot be changed while the drive is running. 	0.000 N·m or lb·ft
	0.000... N·m or lb·ft	Nominal motor torque.	1 = 1 unit

No.	Name/Value	Description	Def/Fb/Eq16
99.13	<i>ID run requested</i>	<p>Selects the type of the motor identification routine (ID run) performed at the next start of the drive. During the ID run, the drive will identify the characteristics of the motor for optimum motor control.</p> <p>If no ID run has been performed yet (or if default parameter values have been restored using parameter 96.06 Parameter restore), this parameter is automatically set to <i>Standstill</i>, signifying that an ID run must be performed.</p> <p>After the ID run, the drive stops and this parameter is automatically set to <i>None</i>.</p> <p>Notes:</p> <ul style="list-style-type: none"> • For the <i>Advanced</i> ID run, the machinery must always be de-coupled from the motor. • With a permanent magnet or synchronous reluctance motor, a <i>Normal</i>, <i>Reduced</i> or <i>Standstill</i> ID run requires that the motor shaft is NOT locked and the load torque is less than 10%. • With scalar control mode (99.04 Motor control mode = <i>Scalar</i>), only the <i>Current measurement calibration</i> ID run mode is possible. • Once the ID run is activated, it can be canceled by stopping the drive. • The ID run must be performed every time any of the motor parameters (99.04, 99.06...99.12) have been changed. • Ensure that the Safe torque off and emergency stop circuits (if any) are closed during the ID run. • Mechanical brake (if present) is not opened by the logic for the ID run. • This parameter cannot be changed while the drive is running. 	<i>None</i>
None	<p>No motor ID run is requested. This mode can be selected only if the ID run (<i>Normal</i>, <i>Reduced</i>, <i>Standstill</i>, <i>Advanced</i>, <i>Advanced Standstill</i>) has already been performed once.</p>	0	

No.	Name/Value	Description	<i>Def/FbEq16</i>
	Normal	<p>Normal ID run. Guarantees good control accuracy for all cases. The ID run takes about 90 seconds. This mode should be selected whenever it is possible.</p> <p>Notes:</p> <ul style="list-style-type: none"> • If the load torque will be higher than 20% of motor nominal torque, or if the machinery is not able to withstand the nominal torque transient during the ID run, then the driven machinery must be de-coupled from the motor during a Normal ID run. • Check the direction of rotation of the motor before starting the ID run. During the run, the motor will rotate in the forward direction. <p> WARNING! The motor will run at up to approximately 50...100% of the nominal speed during the ID run. ENSURE THAT IT IS SAFE TO RUN THE MOTOR BEFORE PERFORMING THE ID RUN!</p>	1
	Reduced	<p>Reduced ID run. This mode should be selected instead of the <i>Normal</i> or <i>Advanced</i> ID Run if</p> <ul style="list-style-type: none"> • mechanical losses are higher than 20% (i.e. the motor cannot be de-coupled from the driven equipment), or if • flux reduction is not allowed while the motor is running (i.e. in case of a motor with an integrated brake supplied from the motor terminals). <p>With this ID run mode, the resultant motor control in the field weakening area or at high torques is not necessarily as accurate as motor control following a Normal ID run. Reduced ID run is completed faster than the Normal ID Run (< 90 seconds).</p> <p>Note: Check the direction of rotation of the motor before starting the ID run. During the run, the motor will rotate in the forward direction.</p> <p> WARNING! The motor will run at up to approximately 50...100% of the nominal speed during the ID run. ENSURE THAT IT IS SAFE TO RUN THE MOTOR BEFORE PERFORMING THE ID RUN!</p>	2

No.	Name/Value	Description	<i>Def/FbEq16</i>
	Standstill	<p>Standstill ID run. The motor is injected with DC current. With an AC induction (asynchronous) motor, the motor shaft is not rotated. With a permanent magnet motor or synchronous reluctance motor, the shaft can rotate up to half a revolution.</p> <p>Note: A standstill ID run should be selected only if the <i>Normal</i>, <i>Reduced</i> or <i>Advanced</i> ID run is not possible due to the restrictions caused by the connected mechanics (eg. with lift or crane applications).</p> <p>See also selection <i>Advanced Standstill</i>.</p>	3
	Autophasing	<p>The autophasing routine determines the start angle of a permanent magnet or synchronous reluctance motor (see page 60). Autophasing does not update the other motor model values.</p> <p>Autophasing is automatically performed as part of the <i>Normal</i>, <i>Reduced</i>, <i>Standstill</i>, <i>Advanced</i> or <i>Advanced Standstill</i> ID runs. Using this setting, it is possible to perform autophasing alone. This is useful after changes in the feedback configuration, such as the replacement or addition of an absolute encoder, resolver, or pulse encoder with commutation signals.</p> <p>Notes:</p> <ul style="list-style-type: none"> • This setting can only be used after a <i>Normal</i>, <i>Reduced</i>, <i>Standstill</i>, <i>Advanced</i> or <i>Advanced Standstill</i> ID run has already been performed. • Depending on the selected autophasing mode, the shaft can rotate during autophasing. See parameter <i>21.13 Autophasing mode</i>. 	4
	Current measurement calibration	<p>Requests current measurement calibration, ie. identification of current measurement offset and gain errors.</p> <p>The calibration will be performed at next start.</p>	5

No.	Name/Value	Description	<i>Def/FbEq16</i>
	Advanced	<p>Advanced ID run. Guarantees the best possible control accuracy. The ID run can take a couple of minutes. This mode should be selected when top performance is needed across the whole operating area.</p> <p>Note: The driven machinery must be de-coupled from the motor because of high torque and speed transients that are applied.</p> <p> WARNING! The motor will run at up to approximately 50...100% of the nominal speed during the ID run. Several accelerations and decelerations are done. ENSURE THAT IT IS SAFE TO RUN THE MOTOR BEFORE PERFORMING THE ID RUN!</p>	6
	Advanced Standstill	<p>Advanced Standstill ID run.</p> <p>This selection is recommended with AC induction motors up to 75 kW instead of the <i>Standstill</i> ID run if</p> <ul style="list-style-type: none"> • the exact nominal ratings of the motor are not known, or • the control performance of the motor is not satisfactory after a <i>Standstill</i> ID run. <p>Note: The time it takes for the <i>Advanced Standstill</i> ID run to complete varies according to motor size. With a small motor, the ID run typically completes within 5 minutes; with a large motor, the ID run may take up to an hour.</p>	7
99.14	<i>Last ID run performed</i>	Shows the type of ID run that was performed last. For more information about the different modes, see the selections of parameter <i>99.13 ID run requested</i> .	<i>None</i>
	None	No ID run has been performed.	0
	Normal	<i>Normal</i> ID run.	1
	Reduced	<i>Reduced</i> ID run.	2
	Standstill	<i>Standstill</i> ID run.	3
	Autophasing	<i>Autophasing</i> .	4
	Current measurement calibration	<i>Current measurement calibration</i> .	5
	Advanced	<i>Advanced</i> ID run.	6
	Advanced Standstill	<i>Advanced Standstill</i> ID run.	7

No.	Name/Value	Description	Def/FbEq16
99.15	<i>Motor polepairs calculated</i>	Calculated number of pole pairs in the motor.	0
	0...1000	Number of pole pairs.	1 = 1
99.16	<i>Motor phase order</i>	<p>Switches the rotation direction of motor. This parameter can be used if the motor turns in the wrong direction (for example, because of the wrong phase order in the motor cable), and correcting the cabling is considered impractical.</p> <p>Notes:</p> <ul style="list-style-type: none"> • Changing this parameter does not affect speed reference polarities, so positive speed reference will rotate the motor forward. The phase order selection just ensures that “forward” is in fact the correct direction. • After changing this parameter, the sign of encoder feedback (if any) must be checked. This can be done by setting parameter <i>90.41 Motor feedback selection</i> to <i>Estimate</i>, and comparing the sign of <i>90.01 Motor speed for control</i> to <i>90.10 Encoder 1 speed</i> (or <i>90.20 Encoder 2 speed</i>). If the sign of the measurement is incorrect, the encoder wiring must be corrected or the sign of <i>90.43 Motor gear numerator</i> reversed. 	<i>U V W</i>
	U V W	Normal.	0
	U W V	Reversed rotation direction.	1

200 Safety

FSO-xx settings.

This group contains parameters related to the optional FSO-xx safety functions module. For details on the parameters in this group, refer to the documentation of the FSO-xx module.

8

Additional parameter data

What this chapter contains

This chapter lists the parameters with some additional data such as their ranges and 32-bit fieldbus scaling. For parameter descriptions, see chapter [Parameters](#) (page 89).

Terms and abbreviations

Term	Definition
Actual signal	Signal measured or calculated by the drive. Usually can only be monitored but not adjusted; some counter-type signals can however be reset.
Analog src	Analog source: the parameter can be set to the value of another parameter by choosing “Other”, and selecting the source parameter from a list. Note: The source parameter must be a 32-bit real (floating point) number. To use a 16-bit integer (for example, received in DDCS data sets) as the source, data storage parameters 47.01...47.08 (see page 324) can be used. In addition to the “Other” selection, the parameter may offer other pre-selected settings.
Binary src	Binary source: the value of the parameter can be taken from a specific bit in another parameter value (“Other”). Sometimes the value can be fixed to 0 (false) or 1 (true). In addition, the parameter may offer other pre-selected settings.
Data	Data parameter.

Term	Definition
FbEq32	32-bit fieldbus equivalent: The scaling between the value shown on the panel and the integer used in communication when a 32-bit value is selected for transmission to an external system. The corresponding 16-bit scalings are listed in chapter Parameters (page 89).
List	Selection list.
No.	Parameter number.
PB	Packed Boolean (bit list).
Real	Real number.
Type	Parameter type. See Analog src , Binary src , List , PB , Real .

Fieldbus addresses

Refer to the *User's manual* of the fieldbus adapter.

Parameter groups 1...9

No.	Name	Type	Range	Unit	FbEq32
01 Actual values					
01.01	Motor speed used	<i>Real</i>	-30000.00 ... 30000.00	rpm	100 = 1 rpm
01.02	Motor speed estimated	<i>Real</i>	-30000.00 ... 30000.00	rpm	100 = 1 rpm
01.03	Motor speed %	<i>Real</i>	-1000.00 ... 1000.00	%	100 = 1%
01.04	Encoder 1 speed filtered	<i>Real</i>	-30000.00 ... 30000.00	rpm	100 = 1 rpm
01.05	Encoder 2 speed filtered	<i>Real</i>	-30000.00 ... 30000.00	rpm	100 = 1 rpm
01.06	Output frequency	<i>Real</i>	-500.00 ... 500.00	Hz	100 = 1 Hz
01.07	Motor current	<i>Real</i>	0.00 ... 30000.00	A	100 = 1 A
01.10	Motor torque	<i>Real</i>	-1600.0 ... 1600.0	%	10 = 1%
01.11	DC voltage	<i>Real</i>	0.00 ... 2000.00	V	100 = 1 V
01.13	Output voltage	<i>Real</i>	0...2000	V	1 = 1 V
01.14	Output power	<i>Real</i>	-32768.00 ... 32767.00	kW or hp	100 = 1 unit
01.15	Output power % of motor nom	<i>Real</i>	-300.00 ... 300.00	%	10 = 1%
01.17	Motor shaft power	<i>Real</i>	-32768.00 ... 32767.00	kW or hp	100 = 1 unit
01.18	Inverter GWh motoring	<i>Real</i>	0...32767	GWh	1 = 1 GWh
01.19	Inverter MWh motoring	<i>Real</i>	0...999	MWh	1 = 1 MWh
01.20	Inverter kWh motoring	<i>Real</i>	0...999	kWh	1 = 1 kWh
01.21	U-phase current	<i>Real</i>	-30000.00 ... 30000.00	A	100 = 1 A
01.22	V-phase current	<i>Real</i>	-30000.00 ... 30000.00	A	100 = 1 A
01.23	W-phase current	<i>Real</i>	-30000.00 ... 30000.00	A	100 = 1 A
01.24	Flux actual %	<i>Real</i>	0...200	%	1 = 1%
01.29	Speed change rate	<i>Real</i>	-15000 ... 15000	rpm/s	1 = 1 rpm/s
01.30	Nominal torque scale	<i>Real</i>	0.000...	N·m or lb·ft	1000 = 1 unit
01.31	Ambient temperature	<i>Real</i>	-40 ... 120	°C or °F	10 = 1°
01.32	Inverter GWh regenerating	<i>Real</i>	0...32767	GWh	1 = 1 GWh
01.33	Inverter MWh regenerating	<i>Real</i>	0...999	MWh	1 = 1 MWh
01.34	Inverter kWh regenerating	<i>Real</i>	0...999	kWh	1 = 1 kWh
01.35	Mot - regen energy GWh	<i>Real</i>	-32768 ... 32767	GWh	1 = 1 GWh
01.36	Mot - regen energy MWh	<i>Real</i>	-999...999	MWh	1 = 1 MWh
01.37	Mot - regen energy kWh	<i>Real</i>	-999...999	kWh	1 = 1 kWh
01.61	Abs motor speed used	<i>Real</i>	0.00 ... 30000.00	rpm	100 = 1 rpm
01.62	Abs motor speed %	<i>Real</i>	0.00 ... 1000.00	%	100 = 1 rpm
01.63	Abs output frequency	<i>Real</i>	0.00 ... 500.00	Hz	100 = 1 Hz
01.64	Abs motor torque	<i>Real</i>	0.0 ... 1600.0	%	10 = 1%
01.65	Abs output power	<i>Real</i>	0.00 ... 32767.00	kW or hp	100 = 1 unit
01.66	Abs output power % motor nom	<i>Real</i>	0.00 ... 300.00	%	10 = 1%
01.68	Abs motor shaft power	<i>Real</i>	0.00 ... 32767.00	kW or hp	100 = 1 unit

438 Additional parameter data

No.	Name	Type	Range	Unit	FbEq32
03 Input references					
03.01	Panel reference	<i>Real</i>	-100000.00 ... 100000.00	-	100 = 1
03.02	Panel reference 2	<i>Real</i>	-30000.00 ... 30000.00	-	100 = 1
03.05	FB A reference 1	<i>Real</i>	-100000.00 ... 100000.00	-	100 = 1
03.06	FB A reference 2	<i>Real</i>	-100000.00 ... 100000.00	-	100 = 1
03.07	FB B reference 1	<i>Real</i>	-100000.00 ... 100000.00	-	100 = 1
03.08	FB B reference 2	<i>Real</i>	-100000.00 ... 100000.00	-	100 = 1
03.09	EFB reference 1	<i>Real</i>	-30000.00 ... 30000.00	-	100 = 1
03.10	EFB reference 2	<i>Real</i>	-30000.00 ... 30000.00	-	100 = 1
03.13	M/F or D2D ref1	<i>Real</i>	-30000.00 ... 30000.00	-	100 = 1
03.14	M/F or D2D ref2	<i>Real</i>	-30000.00 ... 30000.00	-	100 = 1
04 Warnings and faults					
04.01	Tripping fault	<i>Data</i>	0000h...FFFFh	-	1 = 1
04.02	Active fault 2	<i>Data</i>	0000h...FFFFh	-	1 = 1
04.03	Active fault 3	<i>Data</i>	0000h...FFFFh	-	1 = 1
04.04	Active fault 4	<i>Data</i>	0000h...FFFFh	-	1 = 1
04.05	Active fault 5	<i>Data</i>	0000h...FFFFh	-	1 = 1
04.06	Active warning 1	<i>Data</i>	0000h...FFFFh	-	1 = 1
04.07	Active warning 2	<i>Data</i>	0000h...FFFFh	-	1 = 1
04.08	Active warning 3	<i>Data</i>	0000h...FFFFh	-	1 = 1
04.09	Active warning 4	<i>Data</i>	0000h...FFFFh	-	1 = 1
04.10	Active warning 5	<i>Data</i>	0000h...FFFFh	-	1 = 1
04.11	Latest fault	<i>Data</i>	0000h...FFFFh	-	1 = 1
04.12	2nd latest fault	<i>Data</i>	0000h...FFFFh	-	1 = 1
04.13	3rd latest fault	<i>Data</i>	0000h...FFFFh	-	1 = 1
04.14	4th latest fault	<i>Data</i>	0000h...FFFFh	-	1 = 1
04.15	5th latest fault	<i>Data</i>	0000h...FFFFh	-	1 = 1
04.16	Latest warning	<i>Data</i>	0000h...FFFFh	-	1 = 1
04.17	2nd latest warning	<i>Data</i>	0000h...FFFFh	-	1 = 1
04.18	3rd latest warning	<i>Data</i>	0000h...FFFFh	-	1 = 1
04.19	4th latest warning	<i>Data</i>	0000h...FFFFh	-	1 = 1
04.20	5th latest warning	<i>Data</i>	0000h...FFFFh	-	1 = 1
04.21	Fault word 1	<i>PB</i>	0000h...FFFFh	-	1 = 1
04.22	Fault word 2	<i>PB</i>	0000h...FFFFh	-	1 = 1
04.31	Warning word 1	<i>PB</i>	0000h...FFFFh	-	1 = 1
04.32	Warning word 2	<i>PB</i>	0000h...FFFFh	-	1 = 1
04.40	Event word 1	<i>PB</i>	0000h...FFFFh	-	1 = 1
04.41	Event word 1 bit 0 code	<i>Data</i>	0000h...FFFFh	-	1 = 1
04.42	Event word 1 bit 0 aux code	<i>Data</i>	0000 0000h ... FFFF FFFFh	-	1 = 1
04.43	Event word 1 bit 1 code	<i>Data</i>	0000h...FFFFh	-	1 = 1

No.	Name	Type	Range	Unit	FbEq32
04.44	Event word 1 bit 1 aux code	<i>Data</i>	0000 0000h ... FFFF FFFFh	-	1 = 1
...	
04.71	Event word 1 bit 15 code	<i>Data</i>	0000h...FFFFh	-	1 = 1
04.72	Event word 1 bit 15 aux code	<i>Data</i>	0000 0000h ... FFFF FFFFh	-	1 = 1
04.120	Fault/Warning word compatibility	<i>List</i>	0...1	-	1 = 1
05 Diagnostics					
05.01	On-time counter	<i>Real</i>	0...65535	d	1 = 1 d
05.02	Run-time counter	<i>Real</i>	0...65535	d	1 = 1 d
05.04	Fan on-time counter	<i>Real</i>	0...65535	d	1 = 1 d
05.11	Inverter temperature	<i>Real</i>	-40.0 ... 160.0	%	10 = 1%
05.22	Diagnostic word 3	<i>PB</i>	0000h...FFFFh	-	
05.41	Main fan service counter	<i>Real</i>	0...150	%	1 = 1%
05.42	Aux. fan service counter	<i>Real</i>	0...150	%	1 = 1%
06 Control and status words					
06.01	Main control word	<i>PB</i>	0000h...FFFFh	-	1 = 1
06.02	Application control word	<i>PB</i>	0000h...FFFFh	-	1 = 1
06.03	FBA A transparent control word	<i>PB</i>	00000000h...FFFFFFFFh	-	1 = 1
06.04	FBA B transparent control word	<i>PB</i>	00000000h...FFFFFFFFh	-	
06.05	EFB transparent control word	<i>PB</i>	00000000h...FFFFFFFFh	-	
06.11	Main status word	<i>PB</i>	0000h...FFFFh	-	1 = 1
06.16	Drive status word 1	<i>PB</i>	0000h...FFFFh	-	1 = 1
06.17	Drive status word 2	<i>PB</i>	0000h...FFFFh	-	1 = 1
06.18	Start inhibit status word	<i>PB</i>	0000h...FFFFh	-	1 = 1
06.19	Speed control status word	<i>PB</i>	0000h...FFFFh	-	1 = 1
06.20	Constant speed status word	<i>PB</i>	0000h...FFFFh	-	1 = 1
06.21	Drive status word 3	<i>PB</i>	0000h...FFFFh	-	1 = 1
06.25	Drive inhibit status word 2	<i>PB</i>	0000h...FFFFh	-	1 = 1
06.29	MSW bit 10 sel	<i>Binary src</i>	-	-	1 = 1
06.30	MSW bit 11 sel	<i>Binary src</i>	-	-	1 = 1
06.31	MSW bit 12 sel	<i>Binary src</i>	-	-	1 = 1
06.32	MSW bit 13 sel	<i>Binary src</i>	-	-	1 = 1
06.33	MSW bit 14 sel	<i>Binary src</i>	-	-	1 = 1
06.45	Follower CW user bit 0 selection	<i>Binary src</i>	-	-	1 = 1

440 Additional parameter data

No.	Name	Type	Range	Unit	FbEq32
06.46	Follower CW user bit 1 selection	<i>Binary src</i>	-	-	1 = 1
06.47	Follower CW user bit 2 selection	<i>Binary src</i>	-	-	1 = 1
06.48	Follower CW user bit 3 selection	<i>Binary src</i>	-	-	1 = 1
06.50	User status word 1	<i>PB</i>	0000h...FFFFh	-	1 = 1
06.60	User status word 1 bit 0 sel	<i>Binary src</i>	-	-	1 = 1
06.61	User status word 1 bit 1 sel	<i>Binary src</i>	-	-	1 = 1
06.62	User status word 1 bit 2 sel	<i>Binary src</i>	-	-	1 = 1
06.63	User status word 1 bit 3 sel	<i>Binary src</i>	-	-	1 = 1
06.64	User status word 1 bit 4 sel	<i>Binary src</i>	-	-	1 = 1
06.65	User status word 1 bit 5 sel	<i>Binary src</i>	-	-	1 = 1
06.66	User status word 1 bit 6 sel	<i>Binary src</i>	-	-	1 = 1
06.67	User status word 1 bit 7 sel	<i>Binary src</i>	-	-	1 = 1
06.68	User status word 1 bit 8 sel	<i>Binary src</i>	-	-	1 = 1
06.69	User status word 1 bit 9 sel	<i>Binary src</i>	-	-	1 = 1
06.70	User status word 1 bit 10 sel	<i>Binary src</i>	-	-	1 = 1
06.71	User status word 1 bit 11 sel	<i>Binary src</i>	-	-	1 = 1
06.72	User status word 1 bit 12 sel	<i>Binary src</i>	-	-	1 = 1
06.73	User status word 1 bit 13 sel	<i>Binary src</i>	-	-	1 = 1
06.74	User status word 1 bit 14 sel	<i>Binary src</i>	-	-	1 = 1
06.75	User status word 1 bit 15 sel	<i>Binary src</i>	-	-	1 = 1
06.100	User control word 1	<i>PB</i>	0000h...FFFFh	-	1 = 1
06.101	User control word 2	<i>PB</i>	0000h...FFFFh	-	1 = 1
07 System info					
07.03	Drive rating id	<i>List</i>	-	-	1 = 1
07.04	Firmware name	<i>List</i>	-	-	1 = 1
07.05	Firmware version	<i>Data</i>	-	-	1 = 1
07.06	Loading package name	<i>List</i>	-	-	1 = 1
07.07	Loading package version	<i>Data</i>	-	-	1 = 1

No.	Name	Type	Range	Unit	FbEq32
07.08	Bootloader version	<i>Data</i>	-	-	1 = 1
07.11	Cpu usage	<i>Real</i>	0...100	%	1 = 1%
07.13	PU logic version number	<i>Data</i>	-	-	1 = 1
07.21	Application environment status 1	<i>PB</i>	0000h...FFFFh	-	1 = 1
07.22	Application environment status 2	<i>PB</i>	0000h...FFFFh	-	1 = 1
07.23	Application name	<i>Data</i>	-	-	1 = 1
07.24	Application version	<i>Data</i>	-	-	1 = 1
07.25	Customization package name	<i>Data</i>	-	-	1 = 1
07.26	Customization package version	<i>Data</i>	-	-	1 = 1
07.30	Adaptive program status	<i>PB</i>	0000h...FFFFh	-	1 = 1

Parameter groups 10...99

No.	Name	Type	Range	Unit	FbEq32
10 Standard DI, RO					
10.01	DI status	<i>PB</i>	0000h...FFFFh	-	1 = 1
10.02	DI delayed status	<i>PB</i>	0000h...FFFFh	-	1 = 1
10.03	DI force selection	<i>PB</i>	0000h...FFFFh	-	1 = 1
10.04	DI force data	<i>PB</i>	0000h...FFFFh	-	1 = 1
10.05	DI1 ON delay	<i>Real</i>	0.0 ... 3000.0	s	10 = 1 s
10.06	DI1 OFF delay	<i>Real</i>	0.0 ... 3000.0	s	10 = 1 s
10.07	DI2 ON delay	<i>Real</i>	0.0 ... 3000.0	s	10 = 1 s
10.08	DI2 OFF delay	<i>Real</i>	0.0 ... 3000.0	s	10 = 1 s
10.09	DI3 ON delay	<i>Real</i>	0.0 ... 3000.0	s	10 = 1 s
10.10	DI3 OFF delay	<i>Real</i>	0.0 ... 3000.0	s	10 = 1 s
10.11	DI4 ON delay	<i>Real</i>	0.0 ... 3000.0	s	10 = 1 s
10.12	DI4 OFF delay	<i>Real</i>	0.0 ... 3000.0	s	10 = 1 s
10.13	DI5 ON delay	<i>Real</i>	0.0 ... 3000.0	s	10 = 1 s
10.14	DI5 OFF delay	<i>Real</i>	0.0 ... 3000.0	s	10 = 1 s
10.15	DI6 ON delay	<i>Real</i>	0.0 ... 3000.0	s	10 = 1 s
10.16	DI6 OFF delay	<i>Real</i>	0.0 ... 3000.0	s	10 = 1 s
10.21	RO status	<i>PB</i>	0000h...FFFFh	-	1 = 1
10.24	RO1 source	<i>Binary src</i>	-	-	1 = 1
10.25	RO1 ON delay	<i>Real</i>	0.0 ... 3000.0	s	10 = 1 s
10.26	RO1 OFF delay	<i>Real</i>	0.0 ... 3000.0	s	10 = 1 s
10.27	RO2 source	<i>Binary src</i>	-	-	1 = 1
10.28	RO2 ON delay	<i>Real</i>	0.0 ... 3000.0	s	10 = 1 s
10.29	RO2 OFF delay	<i>Real</i>	0.0 ... 3000.0	s	10 = 1 s
10.30	RO3 source	<i>Binary src</i>	-	-	1 = 1
10.31	RO3 ON delay	<i>Real</i>	0.0 ... 3000.0	s	10 = 1 s
10.32	RO3 OFF delay	<i>Real</i>	0.0 ... 3000.0	s	10 = 1 s
10.51	DI filter time	<i>Real</i>	0.3 ... 100.0	ms	10 = 1 ms
10.99	RO/DIO control word	<i>PB</i>	0000h...FFFFh	-	1 = 1
11 Standard DIO, FI, FO					
11.01	DIO status	<i>PB</i>	0000h...FFFFh	-	1 = 1
11.02	DIO delayed status	<i>PB</i>	0000h...FFFFh	-	1 = 1
11.05	DIO1 function	<i>List</i>	0...2	-	1 = 1
11.06	DIO1 output source	<i>Binary src</i>	-	-	1 = 1
11.07	DIO1 ON delay	<i>Real</i>	0.0 ... 3000.0	s	10 = 1 s
11.08	DIO1 OFF delay	<i>Real</i>	0.0 ... 3000.0	s	10 = 1 s
11.09	DIO2 function	<i>List</i>	0...2	-	1 = 1

No.	Name	Type	Range	Unit	FbEq32
11.10	DIO2 output source	<i>Binary src</i>	-		1 = 1
11.11	DIO2 ON delay	<i>Real</i>	0.0 ... 3000.0	s	10 = 1 s
11.12	DIO2 OFF delay	<i>Real</i>	0.0 ... 3000.0	s	10 = 1 s
11.38	Freq in 1 actual value	<i>Real</i>	0...16000	Hz	1 = 1 Hz
11.39	Freq in 1 scaled	<i>Real</i>	-32768.000 ... 32767.000	-	1000 = 1
11.42	Freq in 1 min	<i>Real</i>	0...16000	Hz	1 = 1 Hz
11.43	Freq in 1 max	<i>Real</i>	0...16000	Hz	1 = 1 Hz
11.44	Freq in 1 at scaled min	<i>Real</i>	-32768.000 ... 32767.000	-	1000 = 1
11.45	Freq in 1 at scaled max	<i>Real</i>	-32768.000 ... 32767.000	-	1000 = 1
11.54	Freq out 1 actual value	<i>Real</i>	0...16000	Hz	1 = 1 Hz
11.55	Freq out 1 source	<i>Analog src</i>	-	-	1 = 1
11.58	Freq out 1 src min	<i>Real</i>	-32768.000 ... 32767.000	-	1000 = 1
11.59	Freq out 1 src max	<i>Real</i>	-32768.000 ... 32767.000	-	1000 = 1
11.60	Freq out 1 at src min	<i>Real</i>	0...16000	Hz	1 = 1 Hz
11.61	Freq out 1 at src max	<i>Real</i>	0...16000	Hz	1 = 1 Hz
11.81	DIO filter time	<i>Real</i>	0.3 ... 100.0	ms	10 = 1 ms
12 Standard AI					
12.01	AI tune	enum	0...4	-	
12.03	AI supervision function	<i>List</i>	0...4	-	1 = 1
12.04	AI supervision selection	<i>PB</i>	0000h...FFFFh	-	1 = 1
12.11	AI1 actual value	<i>Real</i>	-22.000 ... 22.000	mA or V	1000 = 1 unit
12.12	AI1 scaled value	<i>Real</i>	-32768.000 ... 32767.000	-	1000 = 1
12.15	AI1 unit selection	<i>List</i>	-	-	1 = 1
12.16	AI1 filter time	<i>Real</i>	0.000 ... 30.000	s	1000 = 1 s
12.17	AI1 min	<i>Real</i>	-22.000 ... 22.000	mA or V	1000 = 1 mA or V
12.18	AI1 max	<i>Real</i>	-22.000 ... 22.000	mA or V	1000 = 1 mA or V
12.19	AI1 scaled at AI1 min	<i>Real</i>	-32768.000 ... 32767.000	-	1000 = 1
12.20	AI1 scaled at AI1 max	<i>Real</i>	-32768.000 ... 32767.000	-	1000 = 1
12.21	AI2 actual value	<i>Real</i>	-22.000 ... 22.000	mA or V	1000 = 1 mA or V
12.22	AI2 scaled value	<i>Real</i>	-32768.000 ... 32767.000	-	1000 = 1
12.25	AI2 unit selection	<i>List</i>	-	-	1 = 1
12.26	AI2 filter time	<i>Real</i>	0.000 ... 30.000	s	1000 = 1 s
12.27	AI2 min	<i>Real</i>	-22.000 ... 22.000	mA or V	1000 = 1 mA or V
12.28	AI2 max	<i>Real</i>	-22.000 ... 22.000	mA or V	1000 = 1 mA or V
12.29	AI2 scaled at AI2 min	<i>Real</i>	-32768.000 ... 32767.000	-	1000 = 1
12.30	AI2 scaled at AI2 max	<i>Real</i>	-32768.000 ... 32767.000	-	1000 = 1

444 Additional parameter data

No.	Name	Type	Range	Unit	FbEq32
13 Standard AO					
13.11	AO1 actual value	<i>Real</i>	0.000 ... 22.000	mA	1000 = 1 mA
13.12	AO1 source	<i>Analog src</i>	-	-	1 = 1
13.16	AO1 filter time	<i>Real</i>	0.000 ... 30.000	s	1000 = 1 s
13.17	AO1 source min	<i>Real</i>	-32768.0 ... 32767.0	-	10 = 1
13.18	AO1 source max	<i>Real</i>	-32768.0 ... 32767.0	-	10 = 1
13.19	AO1 out at AO1 src min	<i>Real</i>	0.000 ... 22.000	mA	1000 = 1 mA
13.20	AO1 out at AO1 src max	<i>Real</i>	0.000 ... 22.000	mA	1000 = 1 mA
13.21	AO2 actual value	<i>Real</i>	0.000 ... 22.000	mA	1000 = 1 mA
13.22	AO2 source	<i>Analog src</i>	-	-	1 = 1
13.26	AO2 filter time	<i>Real</i>	0.000 ... 30.000	s	1000 = 1 s
13.27	AO2 source min	<i>Real</i>	-32768.0 ... 32767.0	-	10 = 1
13.28	AO2 source max	<i>Real</i>	-32768.0 ... 32767.0	-	10 = 1
13.29	AO2 out at AO2 src min	<i>Real</i>	0.000 ... 22.000	mA	1000 = 1 mA
13.30	AO2 out at AO2 src max	<i>Real</i>	0.000 ... 22.000	mA	1000 = 1 mA
13.91	AO1 data storage	<i>Real</i>	-327.68 ... 327.67	-	100 = 1
13.92	AO2 data storage	<i>Real</i>	-327.68 ... 327.67	-	100 = 1
14 I/O extension module 1					
14.01	Module 1 type	<i>List</i>	-	-	1 = 1
14.02	Module 1 location	<i>Real</i>	1...254	-	1 = 1
14.03	Module 1 status	<i>List</i>	0...4	-	1 = 1
<i>Common parameters for DIOx (14.01 Module 1 type = FIO-01 or FIO-11)</i>					
14.05	DIO status	<i>PB</i>	00000000h...FFFFFFFFh	-	1 = 1
14.06	DIO delayed status	<i>PB</i>	00000000h...FFFFFFFFh	-	1 = 1
<i>DIO1/DIO2 (14.01 Module 1 type = FIO-01 or FIO-11)</i>					
14.08	DIO filter time	<i>Real</i>	0.8 ... 100.0	ms	10 = 1 ms
14.09	DIO1 function	<i>List</i>	0...1	-	1 = 1
14.11	DIO1 output source	<i>Binary src</i>	-	-	1 = 1
14.12	DIO1 ON delay	<i>Real</i>	0.0 ... 3000.0	s	10 = 1 s
14.13	DIO1 OFF delay	<i>Real</i>	0.0 ... 3000.0	s	10 = 1 s
14.14	DIO2 function	<i>List</i>	0...1	-	1 = 1
14.16	DIO2 output source	<i>Binary src</i>	-	-	1 = 1
14.17	DIO2 ON delay	<i>Real</i>	0.0 ... 3000.0	s	10 = 1 s
14.18	DIO2 OFF delay	<i>Real</i>	0.0 ... 3000.0	s	10 = 1 s
<i>DIO3/DIO4 (14.01 Module 1 type = FIO-01)</i>					
14.19	DIO3 function	<i>List</i>	0...1	-	1 = 1
14.21	DIO3 output source	<i>Binary src</i>	-	-	1 = 1
14.22	DIO3 ON delay	<i>Real</i>	0.0 ... 3000.0	s	10 = 1 s

No.	Name	Type	Range	Unit	FbEq32
14.23	DIO3 OFF delay	<i>Real</i>	0.0 ... 3000.0	s	10 = 1 s
14.24	DIO4 function	<i>List</i>	0...1	-	1 = 1
14.26	DIO4 output source	<i>Binary src</i>	-	-	1 = 1
14.27	DIO4 ON delay	<i>Real</i>	0.0 ... 3000.0	s	10 = 1 s
14.28	DIO4 OFF delay	<i>Real</i>	0.0 ... 3000.0	s	10 = 1 s
<i>RO1/RO2 (14.01 Module 1 type = FIO-01)</i>					
14.31	RO status	<i>PB</i>	0000h...FFFFh	-	1 = 1
14.34	RO1 source	<i>Binary src</i>	-	-	1 = 1
14.35	RO1 ON delay	<i>Real</i>	0.0 ... 3000.0	s	10 = 1 s
14.36	RO1 OFF delay	<i>Real</i>	0.0 ... 3000.0	s	10 = 1 s
14.37	RO2 source	<i>Binary src</i>	-	-	1 = 1
14.38	RO2 ON delay	<i>Real</i>	0.0 ... 3000.0	s	10 = 1 s
14.39	RO2 OFF delay	<i>Real</i>	0.0 ... 3000.0	s	10 = 1 s
<i>Common parameters for Alx (14.01 Module 1 type = FIO-11)</i>					
14.19	Al supervision function	<i>List</i>	0...4	-	1 = 1
14.20	Al supervision selection	<i>PB</i>	0000h...FFFFh	-	1 = 1
14.21	Al tune	<i>List</i>	0...6 (<i>FIO-11</i>)	-	1 = 1
14.22	Al force selection	<i>PB</i>	0000h...FFFFh	-	1 = 1
<i>AI1/AI2 (14.01 Module 1 type = FIO-11)</i>					
14.26	AI1 actual value	<i>Real</i>	-22.000 ... 22.000	mA or V	1000 = 1 unit
14.27	AI1 scaled value	<i>Real</i>	-32768.000 ... 32767.000	-	1000 = 1
14.28	AI1 force data	<i>Real</i>	-22.000 ... 22.000	mA or V	1000 = 1 unit
14.29	AI1 HW switch position	<i>List</i>	-	-	1 = 1
14.30	AI1 unit selection	<i>List</i>	-	-	1 = 1
14.31	AI1 filter gain	<i>List</i>	0...7	-	1 = 1
14.32	AI1 filter time	<i>Real</i>	0.000 ... 30.000	s	1000 = 1 s
14.33	AI1 min	<i>Real</i>	-22.000 ... 22.000	mA or V	1000 = 1 mA or V
14.34	AI1 max	<i>Real</i>	-22.000 ... 22.000	mA or V	1000 = 1 mA or V
14.35	AI1 scaled at AI1 min	<i>Real</i>	-32768.000 ... 32767.000	-	1000 = 1
14.36	AI1 scaled at AI1 max	<i>Real</i>	-32768.000 ... 32767.000	-	1000 = 1
14.41	AI2 actual value	<i>Real</i>	-22.000 ... 22.000	mA or V	1000 = 1 unit
14.42	AI2 scaled value	<i>Real</i>	-32768.000 ... 32767.000	-	1000 = 1
14.43	AI2 force data	<i>Real</i>	-22.000 ... 22.000	mA or V	1000 = 1 unit
14.44	AI2 HW switch position	<i>List</i>	-	-	1 = 1
14.45	AI2 unit selection	<i>List</i>	-	-	1 = 1
14.46	AI2 filter gain	<i>List</i>	0...7	-	1 = 1
14.47	AI2 filter time	<i>Real</i>	0.000 ... 30.000	s	1000 = 1 s

446 Additional parameter data

No.	Name	Type	Range	Unit	FbEq32
14.48	AI2 min	<i>Real</i>	-22.000 ... 22.000	mA or V	1000 = 1 mA or V
14.49	AI2 max	<i>Real</i>	-22.000 ... 22.000	mA or V	1000 = 1 mA or V
14.50	AI2 scaled at AI2 min	<i>Real</i>	-32768.000 ... 32767.000	-	1000 = 1
14.51	AI2 scaled at AI2 max	<i>Real</i>	-32768.000 ... 32767.000	-	1000 = 1
<i>AI3 (14.01 Module 1 type = FIO-11)</i>					
14.56	AI3 actual value	<i>Real</i>	-22.000 ... 22.000	mA or V	1000 = 1 unit
14.57	AI3 scaled value	<i>Real</i>	-32768.000 ... 32767.000	-	1000 = 1
14.58	AI3 force data	<i>Real</i>	-22.000 ... 22.000	mA or V	1000 = 1 unit
14.59	AI3 HW switch position	<i>List</i>	-	-	1 = 1
14.60	AI3 unit selection	<i>List</i>	-	-	1 = 1
14.61	AI3 filter gain	<i>List</i>	0...7	-	1 = 1
14.62	AI3 filter time	<i>Real</i>	0.000 ... 30.000	s	1000 = 1 s
14.63	AI3 min	<i>Real</i>	-22.000 ... 22.000	mA or V	1000 = 1 mA or V
14.64	AI3 max	<i>Real</i>	-22.000 ... 22.000	mA or V	1000 = 1 mA or V
14.65	AI3 scaled at AI3 min	<i>Real</i>	-32768.000 ... 32767.000	-	1000 = 1
14.66	AI3 scaled at AI3 max	<i>Real</i>	-32768.000 ... 32767.000	-	1000 = 1
<i>Common parameters for AOx (14.01 Module 1 type = FIO-11)</i>					
14.71	AO force selection	<i>PB</i>	00000000h...FFFFFFFFh	-	1 = 1
<i>AO1 (14.01 Module 1 type = FIO-11)</i>					
14.76	AO1 actual value	<i>Real</i>	0.000 ... 22.000	mA	1000 = 1 mA
14.77	AO1 source	<i>Analog src</i>	-	-	1 = 1
14.78	AO1 force data	<i>Real</i>	0.000 ... 22.000	mA	1000 = 1 mA
14.79	AO1 filter time	<i>Real</i>	0.000 ... 30.000	s	1000 = 1 s
14.80	AO1 source min	<i>Real</i>	-32768.0 ... 32767.0	-	10 = 1
14.81	AO1 source max	<i>Real</i>	-32768.0 ... 32767.0	-	10 = 1
14.82	AO1 out at AO1 src min	<i>Real</i>	0.000 ... 22.000	mA	1000 = 1 mA
14.83	AO1 out at AO1 src max	<i>Real</i>	0.000 ... 22.000	mA	1000 = 1 mA
15 I/O extension module 2					
15.01	Module 2 type	<i>List</i>	-	-	1 = 1
15.02	Module 2 location	<i>Real</i>	1...254	-	1 = 1
15.03	Module 2 status	<i>List</i>	0...2	-	1 = 1
<i>Common parameters for DIOx (15.01 Module 2 type = FIO-01 or FIO-11)</i>					
15.05	DIO status	<i>PB</i>	00000000h...FFFFFFFFh	-	1 = 1
15.06	DIO delayed status	<i>PB</i>	00000000h...FFFFFFFFh	-	1 = 1
<i>DIO1/DIO2 (15.01 Module 2 type = FIO-01 or FIO-11)</i>					
15.08	DIO filter time	<i>Real</i>	0.8 ... 100.0	ms	10 = 1 ms
15.09	DIO1 function	<i>List</i>	0...1	-	1 = 1

No.	Name	Type	Range	Unit	FbEq32
15.11	DIO1 output source	<i>Binary src</i>	-	-	1 = 1
15.12	DIO1 ON delay	<i>Real</i>	0.0 ... 3000.0	s	10 = 1 s
15.13	DIO1 OFF delay	<i>Real</i>	0.0 ... 3000.0	s	10 = 1 s
15.14	DIO2 function	<i>List</i>	0...1	-	1 = 1
15.16	DIO2 output source	<i>Binary src</i>	-	-	1 = 1
15.17	DIO2 ON delay	<i>Real</i>	0.0 ... 3000.0	s	10 = 1 s
15.18	DIO2 OFF delay	<i>Real</i>	0.0 ... 3000.0	s	10 = 1 s
<i>DIO3/DIO4 (15.01 Module 2 type = FIO-01)</i>					
15.19	DIO3 function	<i>List</i>	0...1	-	1 = 1
15.21	DIO3 output source	<i>Binary src</i>	-	-	1 = 1
15.22	DIO3 ON delay	<i>Real</i>	0.0 ... 3000.0	s	10 = 1 s
15.23	DIO3 OFF delay	<i>Real</i>	0.0 ... 3000.0	s	10 = 1 s
15.24	DIO4 function	<i>List</i>	0...1	-	1 = 1
15.26	DIO4 output source	<i>Binary src</i>	-	-	1 = 1
15.27	DIO4 ON delay	<i>Real</i>	0.0 ... 3000.0	s	10 = 1 s
15.28	DIO4 OFF delay	<i>Real</i>	0.0 ... 3000.0	s	10 = 1 s
<i>RO1/RO2 (15.01 Module 2 type = FIO-01)</i>					
15.31	RO status	<i>PB</i>	0000h...FFFFh	-	1 = 1
15.34	RO1 source	<i>Binary src</i>	-	-	1 = 1
15.35	RO1 ON delay	<i>Real</i>	0.0 ... 3000.0	s	10 = 1 s
15.36	RO1 OFF delay	<i>Real</i>	0.0 ... 3000.0	s	10 = 1 s
15.37	RO2 source	<i>Binary src</i>	-	-	1 = 1
15.38	RO2 ON delay	<i>Real</i>	0.0 ... 3000.0	s	10 = 1 s
15.39	RO2 OFF delay	<i>Real</i>	0.0 ... 3000.0	s	10 = 1 s
<i>Common parameters for AIx (15.01 Module 2 type = FIO-11)</i>					
15.19	AI supervision function	<i>List</i>	0...4	-	1 = 1
15.20	AI supervision selection	<i>PB</i>	0000h...FFFFh	-	1 = 1
15.21	AI tune	<i>List</i>	0...6 (<i>FIO-11</i>)	-	1 = 1
15.22	AI force selection	<i>PB</i>	00000000h...FFFFFFFFh	-	1 = 1
<i>AI1/AI2 (15.01 Module 2 type = FIO-11)</i>					
15.26	AI1 actual value	<i>Real</i>	-22.000 ... 22.000	mA or V	1000 = 1 unit
15.27	AI1 scaled value	<i>Real</i>	-32768.000 ... 32767.000	-	1000 = 1
15.28	AI1 force data	<i>Real</i>	-22.000 ... 22.000	mA or V	1000 = 1 unit
15.29	AI1 HW switch position	<i>List</i>	-	-	1 = 1
15.30	AI1 unit selection	<i>List</i>	-	-	1 = 1
15.31	AI1 filter gain	<i>List</i>	0...7	-	1 = 1
15.32	AI1 filter time	<i>Real</i>	0.000 ... 30.000	s	1000 = 1 s

448 Additional parameter data

No.	Name	Type	Range	Unit	FbEq32
15.33	AI1 min	<i>Real</i>	-22.000 ... 22.000	mA or V	1000 = 1 mA or V
15.34	AI1 max	<i>Real</i>	-22.000 ... 22.000	mA or V	1000 = 1 mA or V
15.35	AI1 scaled at AI1 min	<i>Real</i>	-32768.000 ... 32767.000	-	1000 = 1
15.36	AI1 scaled at AI1 max	<i>Real</i>	-32768.000 ... 32767.000	-	1000 = 1
15.41	AI2 actual value	<i>Real</i>	-22.000 ... 22.000	mA or V	1000 = 1 unit
15.42	AI2 scaled value	<i>Real</i>	-32768.000 ... 32767.000	-	1000 = 1
15.43	AI2 force data	<i>Real</i>	-22.000 ... 22.000	mA or V	1000 = 1 unit
15.44	AI2 HW switch position	<i>List</i>	-	-	1 = 1
15.45	AI2 unit selection	<i>List</i>	-	-	1 = 1
15.46	AI2 filter gain	<i>List</i>	0...7	-	1 = 1
15.47	AI2 filter time	<i>Real</i>	0.000 ... 30.000	s	1000 = 1 s
15.48	AI2 min	<i>Real</i>	-22.000 ... 22.000	mA or V	1000 = 1 mA or V
15.49	AI2 max	<i>Real</i>	-22.000 ... 22.000	mA or V	1000 = 1 mA or V
15.50	AI2 scaled at AI2 min	<i>Real</i>	-32768.000 ... 32767.000	-	1000 = 1
15.51	AI2 scaled at AI2 max	<i>Real</i>	-32768.000 ... 32767.000	-	1000 = 1
<i>AI3 (15.01 Module 2 type = FIO-11)</i>					
15.56	AI3 actual value	<i>Real</i>	-22.000 ... 22.000	mA or V	1000 = 1 unit
15.57	AI3 scaled value	<i>Real</i>	-32768.000 ... 32767.000	-	1000 = 1
15.58	AI3 force data	<i>Real</i>	-22.000 ... 22.000	mA or V	1000 = 1 unit
15.59	AI3 HW switch position	<i>List</i>	-	-	1 = 1
15.60	AI3 unit selection	<i>List</i>	-	-	1 = 1
15.61	AI3 filter gain	<i>List</i>	0...7	-	1 = 1
15.62	AI3 filter time	<i>Real</i>	0.000 ... 30.000	s	1000 = 1 s
15.63	AI3 min	<i>Real</i>	-22.000 ... 22.000	mA or V	1000 = 1 mA or V
15.64	AI3 max	<i>Real</i>	-22.000 ... 22.000	mA or V	1000 = 1 mA or V
15.65	AI3 scaled at AI3 min	<i>Real</i>	-32768.000 ... 32767.000	-	1000 = 1
15.66	AI3 scaled at AI3 max	<i>Real</i>	-32768.000 ... 32767.000	-	1000 = 1
<i>Common parameters for AOx (15.01 Module 2 type = FIO-11)</i>					
15.71	AO force selection	<i>PB</i>	00000000h...FFFFFFFFh	-	1 = 1
<i>AO1 (15.01 Module 2 type = FIO-11)</i>					
15.76	AO1 actual value	<i>Real</i>	0.000 ... 22.000	mA	1000 = 1 mA
15.77	AO1 source	<i>Analog src</i>	-	-	1 = 1
15.78	AO1 force data	<i>Real</i>	0.000 ... 22.000	mA	1000 = 1 mA
15.79	AO1 filter time	<i>Real</i>	0.000 ... 30.000	s	1000 = 1 s
15.80	AO1 source min	<i>Real</i>	-32768.0 ... 32767.0	-	10 = 1
15.81	AO1 source max	<i>Real</i>	-32768.0 ... 32767.0	-	10 = 1

No.	Name	Type	Range	Unit	FbEq32
15.82	AO1 out at AO1 src min	<i>Real</i>	0.000 ... 22.000	mA	1000 = 1 mA
15.83	AO1 out at AO1 src max	<i>Real</i>	0.000 ... 22.000	mA	1000 = 1 mA
19 Operation mode					
19.01	Actual operation mode	<i>List</i>	-	-	1 = 1
19.11	Ext1/Ext2 selection	<i>Binary src</i>	-	-	1 = 1
19.12	Ext1 control mode	<i>List</i>	1...6	-	1 = 1
19.14	Ext2 control mode	<i>List</i>	1...6	-	1 = 1
19.16	Local control mode	<i>List</i>	0...1	-	1 = 1
19.17	Local control disable	<i>List</i>	0...1	-	1 = 1
19.20	Scalar control reference unit	<i>List</i>	0...1	-	1 = 1
20 Start/stop/direction					
20.01	Ext1 commands	<i>List</i>	-	-	1 = 1
20.02	Ext1 start trigger type	<i>List</i>	0...1	-	1 = 1
20.03	Ext1 in1 source	<i>Binary src</i>	-	-	1 = 1
20.04	Ext1 in2 source	<i>Binary src</i>	-	-	1 = 1
20.05	Ext1 in3 source	<i>Binary src</i>	-	-	1 = 1
20.06	Ext2 commands	<i>List</i>	-	-	1 = 1
20.07	Ext2 start trigger type	<i>List</i>	0...1	-	1 = 1
20.08	Ext2 in1 source	<i>Binary src</i>	-	-	1 = 1
20.09	Ext2 in2 source	<i>Binary src</i>	-	-	1 = 1
20.10	Ext2 in3 source	<i>Binary src</i>	-	-	1 = 1
20.11	Run enable stop mode	<i>List</i>	0...2	-	1 = 1
20.12	Run enable 1 source	<i>Binary src</i>	-	-	1 = 1
20.19	Enable start command	<i>Binary src</i>	-	-	1 = 1
20.23	Positive speed enable	<i>Binary src</i>	-	-	1 = 1
20.24	Negative speed enable	<i>Binary src</i>	-	-	1 = 1
20.25	Jogging enable	<i>Binary src</i>	-	-	1 = 1
20.26	Jogging 1 start source	<i>Binary src</i>	-	-	1 = 1
20.27	Jogging 2 start source	<i>Binary src</i>	-	-	1 = 1
20.30	Enable signals warning function	<i>PB</i>	00b...11b	-	1 = 1

450 Additional parameter data

No.	Name	Type	Range	Unit	FbEq32
21 Start/stop mode					
21.01	Start mode	<i>List</i>	0...2	-	1 = 1
21.02	Magnetization time	<i>Real</i>	0...10000	ms	1 = 1 ms
21.03	Stop mode	<i>List</i>	0...2	-	1 = 1
21.04	Emergency stop mode	<i>List</i>	0...2	-	1 = 1
21.05	Emergency stop source	<i>Binary src</i>	-	-	1 = 1
21.06	Zero speed limit	<i>Real</i>	0.00 ... 30000.00	rpm	100 = 1 rpm
21.07	Zero speed delay	<i>Real</i>	0...30000	ms	1 = 1 ms
21.08	DC current control	<i>PB</i>	00b...11b	-	1 = 1
21.09	DC hold speed	<i>Real</i>	0.00 ... 1000.00	rpm	100 = 1 rpm
21.10	DC current reference	<i>Real</i>	0.0 ... 100.0	%	10 = 1%
21.11	Post magnetization time	<i>Real</i>	0...3000	s	1 = 1 s
21.12	Continuous magnetization command	<i>Binary src</i>	-	-	1 = 1
21.13	Autophasing mode	<i>List</i>	0...3	-	1 = 1
21.14	Pre-heating input source	<i>Binary src</i>	-	-	1 = 1
21.16	Pre-heating current	<i>Real</i>	0.0 ... 30.0	%	10 = 1%
21.18	Auto restart time	<i>Real</i>	0.0, 0.1 ... 5.0	s	10 = 1 s
21.19	Scalar start mode	<i>List</i>	0...2	-	1 = 1
21.20	Follower force ramp stop	<i>Binary src</i>	-	-	1 = 1
22 Speed reference selection					
22.01	Speed ref unlimited	<i>Real</i>	-30000.00 ... 30000.00	rpm	100 = 1 rpm
22.11	Speed ref1 source	<i>Analog src</i>	-	-	1 = 1
22.12	Speed ref2 source	<i>Analog src</i>	-	-	1 = 1
22.13	Speed ref1 function	<i>List</i>	0...5	-	1 = 1
22.14	Speed ref1/2 selection	<i>Binary src</i>	-	-	1 = 1
22.15	Speed additive 1 source	<i>Analog src</i>	-	-	1 = 1
22.16	Speed share	<i>Real</i>	-8.000 ... 8.000	-	1000 = 1
22.17	Speed additive 2 source	<i>Analog src</i>	-	-	1 = 1
22.21	Constant speed function	<i>PB</i>	00b...11b	-	1 = 1
22.22	Constant speed sel1	<i>Binary src</i>	-	-	1 = 1
22.23	Constant speed sel2	<i>Binary src</i>	-	-	1 = 1
22.24	Constant speed sel3	<i>Binary src</i>	-	-	1 = 1
22.26	Constant speed 1	<i>Real</i>	-30000.00 ... 30000.00	rpm	100 = 1 rpm

No.	Name	Type	Range	Unit	FbEq32
22.27	Constant speed 2	<i>Real</i>	-30000.00 ... 30000.00	rpm	100 = 1 rpm
22.28	Constant speed 3	<i>Real</i>	-30000.00 ... 30000.00	rpm	100 = 1 rpm
22.29	Constant speed 4	<i>Real</i>	-30000.00 ... 30000.00	rpm	100 = 1 rpm
22.30	Constant speed 5	<i>Real</i>	-30000.00 ... 30000.00	rpm	100 = 1 rpm
22.31	Constant speed 6	<i>Real</i>	-30000.00 ... 30000.00	rpm	100 = 1 rpm
22.32	Constant speed 7	<i>Real</i>	-30000.00 ... 30000.00	rpm	100 = 1 rpm
22.41	Speed ref safe	<i>Real</i>	-30000.00 ... 30000.00	rpm	100 = 1 rpm
22.42	Jogging 1 ref	<i>Real</i>	-30000.00 ... 30000.00	rpm	100 = 1 rpm
22.43	Jogging 2 ref	<i>Real</i>	-30000.00 ... 30000.00	rpm	100 = 1 rpm
22.51	Critical speed function	<i>PB</i>	00b...11b	-	1 = 1
22.52	Critical speed 1 low	<i>Real</i>	-30000.00 ... 30000.00	rpm	100 = 1 rpm
22.53	Critical speed 1 high	<i>Real</i>	-30000.00 ... 30000.00	rpm	100 = 1 rpm
22.54	Critical speed 2 low	<i>Real</i>	-30000.00 ... 30000.00	rpm	100 = 1 rpm
22.55	Critical speed 2 high	<i>Real</i>	-30000.00 ... 30000.00	rpm	100 = 1 rpm
22.56	Critical speed 3 low	<i>Real</i>	-30000.00 ... 30000.00	rpm	100 = 1 rpm
22.57	Critical speed 3 high	<i>Real</i>	-30000.00 ... 30000.00	rpm	100 = 1 rpm
22.71	Motor potentiometer function	<i>List</i>	0...2	-	1 = 1
22.72	Motor potentiometer initial value	<i>Real</i>	-32768.00 ... 32767.00	-	100 = 1
22.73	Motor potentiometer up source	<i>Binary src</i>	-	-	1 = 1
22.74	Motor potentiometer down source	<i>Binary src</i>	-	-	1 = 1
22.75	Motor potentiometer ramp time	<i>Real</i>	0.0 ... 3600.0	s	10 = 1 s
22.76	Motor potentiometer min value	<i>Real</i>	-32768.00 ... 32767.00	-	100 = 1
22.77	Motor potentiometer max value	<i>Real</i>	-32768.00 ... 32767.00	-	100 = 1
22.80	Motor potentiometer ref act	<i>Real</i>	-32768.00 ... 32767.00	-	100 = 1
22.81	Speed reference act 1	<i>Real</i>	-30000.00 ... 30000.00	rpm	100 = 1 rpm
22.82	Speed reference act 2	<i>Real</i>	-30000.00 ... 30000.00	rpm	100 = 1 rpm
22.83	Speed reference act 3	<i>Real</i>	-30000.00 ... 30000.00	rpm	100 = 1 rpm
22.84	Speed reference act 4	<i>Real</i>	-30000.00 ... 30000.00	rpm	100 = 1 rpm
22.85	Speed reference act 5	<i>Real</i>	-30000.00 ... 30000.00	rpm	100 = 1 rpm
22.86	Speed reference act 6	<i>Real</i>	-30000.00 ... 30000.00	rpm	100 = 1 rpm
22.87	Speed reference act 7	<i>Real</i>	-30000.00 ... 30000.00	rpm	100 = 1 rpm
23 Speed reference ramp					
23.01	Speed ref ramp input	<i>Real</i>	-30000.00 ... 30000.00	rpm	100 = 1 rpm
23.02	Speed ref ramp output	<i>Real</i>	-30000.00 ... 30000.00	rpm	100 = 1 rpm
23.11	Ramp set selection	<i>Binary src</i>	-	-	1 = 1
23.12	Acceleration time 1	<i>Real</i>	0.000 ... 1800.000	s	1000 = 1 s
23.13	Deceleration time 1	<i>Real</i>	0.000 ... 1800.000	s	1000 = 1 s
23.14	Acceleration time 2	<i>Real</i>	0.000 ... 1800.000	s	1000 = 1 s

452 Additional parameter data

No.	Name	Type	Range	Unit	FbEq32
23.15	Deceleration time 2	<i>Real</i>	0.000 ... 1800.000	s	1000 = 1 s
23.16	Shape time acc 1	<i>Real</i>	0.000 ... 1800.000	s	1000 = 1 s
23.17	Shape time acc 2	<i>Real</i>	0.000 ... 1800.000	s	1000 = 1 s
23.18	Shape time dec 1	<i>Real</i>	0.000 ... 1800.000	s	1000 = 1 s
23.19	Shape time dec 2	<i>Real</i>	0.000 ... 1800.000	s	1000 = 1 s
23.20	Acc time jogging	<i>Real</i>	0.000 ... 1800.000	s	1000 = 1 s
23.21	Dec time jogging	<i>Real</i>	0.000 ... 1800.000	s	1000 = 1 s
23.23	Emergency stop time	<i>Real</i>	0.000 ... 1800.000	s	1000 = 1 s
23.24	Speed ramp in zero source	<i>Binary src</i>	-	-	1 = 1
23.26	Ramp out balancing enable	<i>Binary src</i>	-	-	1 = 1
23.27	Ramp out balancing ref	<i>Real</i>	-30000.00 ... 30000.00	rpm	100 = 1 rpm
23.28	Variable slope enable	<i>List</i>	0...1	-	1 = 1
23.29	Variable slope rate	<i>Real</i>	2...30000	ms	1 = 1 ms
23.39	Follower speed correction out	<i>Real</i>	-30000.00 ... 30000.00	rpm	100 = 1 rpm
23.40	Follower speed correction enable	<i>Binary src</i>	-	-	1 = 1
23.41	Follower speed correction gain	<i>Real</i>	0.00 ... 100.00	%	100 = 1%
23.42	Follower speed corr torq source	<i>Analog src</i>	-	-	1 = 1
24 Speed reference conditioning					
24.01	Used speed reference	<i>Real</i>	-30000.00 ... 30000.00	rpm	100 = 1 rpm
24.02	Used speed feedback	<i>Real</i>	-30000.00 ... 30000.00	rpm	100 = 1 rpm
24.03	Speed error filtered	<i>Real</i>	-30000.0 ... 30000.0	rpm	100 = 1 rpm
24.04	Speed error inverted	<i>Real</i>	-30000.0 ... 30000.0	rpm	100 = 1 rpm
24.11	Speed correction	<i>Real</i>	-10000.00 ... 10000.00	rpm	100 = 1 rpm
24.12	Speed error filter time	<i>Real</i>	0...10000	ms	1 = 1 ms
24.41	Speed error window control enable	<i>Binary src</i>	-	-	1 = 1
24.42	Speed window control mode	<i>List</i>	0...1	-	1 = 1
24.43	Speed error window high	<i>Real</i>	0.00 ... 3000.00	rpm	100 = 1 rpm
24.44	Speed error window low	<i>Real</i>	0.00 ... 3000.00	rpm	100 = 1 rpm
24.46	Speed error step	<i>Real</i>	-3000.00 ... 3000.00	rpm	100 = 1 rpm
25 Speed control					
25.01	Torque reference speed control	<i>Real</i>	-1600.0 ... 1600.0	%	10 = 1%
25.02	Speed proportional gain	<i>Real</i>	0.00 ... 250.00	-	100 = 1
25.03	Speed integration time	<i>Real</i>	0.00 ... 1000.00	s	100 = 1 s
25.04	Speed derivation time	<i>Real</i>	0.000 ... 10.000	s	1000 = 1 s
25.05	Derivation filter time	<i>Real</i>	0...10000	ms	1 = 1 ms
25.06	Acc comp derivation time	<i>Real</i>	0.00 ... 1000.00	s	100 = 1 s
25.07	Acc comp filter time	<i>Real</i>	0.0 ... 1000.0	ms	10 = 1 ms

No.	Name	Type	Range	Unit	FbEq32
25.08	Drooping rate	<i>Real</i>	0.00 ... 100.00	%	100 = 1%
25.09	Speed ctrl balancing enable	<i>Binary src</i>	-	-	1 = 1
25.10	Speed ctrl balancing ref	<i>Real</i>	-300.0 ... 300.0	%	10 = 1%
25.11	Speed control min torque	<i>Real</i>	-1600.0 ... 0.0	%	10 = 1%
25.12	Speed control max torque	<i>Real</i>	0.0 ... 1600.0	%	10 = 1%
25.13	Min torq sp ctrl em stop	<i>Real</i>	-1600 ... 0	%	10 = 1%
25.14	Max torq sp ctrl em stop	<i>Real</i>	0...1600	%	10 = 1%
25.15	Proportional gain em stop	<i>Real</i>	1.00 ... 250.00	-	100 = 1
25.18	Speed adapt min limit	<i>Real</i>	0...30000	rpm	1 = 1 rpm
25.19	Speed adapt max limit	<i>Real</i>	0...30000	rpm	1 = 1 rpm
25.21	Kp adapt coef at min speed	<i>Real</i>	0.000 ... 10.000	-	1000 = 1
25.22	Ti adapt coef at min speed	<i>Real</i>	0.000 ... 10.000	-	1000 = 1
25.25	Torque adapt max limit	<i>Real</i>	0.0 ... 1600.0	%	10 = 1%
25.26	Torque adapt filt time	<i>Real</i>	0.000 ... 100.000	s	1000 = 1 s
25.27	Kp adapt coef at min torque	<i>Real</i>	0.000 ... 10.000	-	1000 = 1
25.30	Flux adaption enable	<i>List</i>	0...1	-	1 = 1
25.33	Speed controller autotune	<i>Binary src</i>	-	-	1 = 1
25.34	Speed controller autotune mode	<i>List</i>	0...2	-	1 = 1
25.37	Mechanical time constant	<i>Real</i>	0.00 ... 1000.00	s	100 = 1 s
25.38	Autotune torque step	<i>Real</i>	0.00 ... 100.00	%	100 = 1%
25.39	Autotune speed step	<i>Real</i>	0.00 ... 100.00	%	100 = 1%
25.40	Autotune repeat times	<i>Real</i>	1...10	-	1 = 1
25.53	Torque prop reference	<i>Real</i>	-30000.0 ... 30000.0	%	10 = 1%
25.54	Torque integral reference	<i>Real</i>	-30000.0 ... 30000.0	%	10 = 1%
25.55	Torque deriv reference	<i>Real</i>	-30000.0 ... 30000.0	%	10 = 1%
25.56	Torque acc compensation	<i>Real</i>	-30000.0 ... 30000.0	%	10 = 1%
25.57	Torque reference unbalanced	<i>Real</i>	-30000.0 ... 30000.0	%	10 = 1%
26 Torque reference chain					
26.01	Torque reference to TC	<i>Real</i>	-1600.0 ... 1600.0	%	10 = 1%
26.02	Torque reference used	<i>Real</i>	-1600.0 ... 1600.0	%	10 = 1%
26.08	Minimum torque ref	<i>Real</i>	-1000.0 ... 0.0	%	10 = 1%
26.09	Maximum torque ref	<i>Real</i>	0.0 ... 1000.0	%	10 = 1%
26.11	Torque ref1 source	<i>Analog src</i>	-	-	1 = 1
26.12	Torque ref2 source	<i>Analog src</i>	-	-	1 = 1
26.13	Torque ref1 function	<i>List</i>	0...5	-	1 = 1
26.14	Torque ref1/2 selection	<i>Binary src</i>	-	-	1 = 1
26.15	Load share	<i>Real</i>	-8.000 ... 8.000	-	1000 = 1

454 Additional parameter data

No.	Name	Type	Range	Unit	FbEq32
26.16	Torque additive 1 source	<i>Analog src</i>	-	-	1 = 1
26.17	Torque ref filter time	<i>Real</i>	0.000 ... 30.000	s	1000 = 1 s
26.18	Torque ramp up time	<i>Real</i>	0.000 ... 60.000	s	1000 = 1 s
26.19	Torque ramp down time	<i>Real</i>	0.000 ... 60.000	s	1000 = 1 s
26.25	Torque additive 2 source	<i>Analog src</i>	-	-	1 = 1
26.26	Force torque ref add 2 zero	<i>Binary src</i>	-	-	1 = 1
26.41	Torque step	<i>Real</i>	-300.0 ... 300.0	%	10 = 1%
26.42	Torque step enable	<i>List</i>	0...1	-	1 = 1
26.51	Oscillation damping	<i>Binary src</i>	-	-	1 = 1
26.52	Oscillation damping out enable	<i>Binary src</i>	-	-	1 = 1
26.53	Oscillation compensation input	<i>List</i>	0...1	-	1 = 1
26.55	Oscillation damping frequency	<i>Real</i>	0.1 ... 60.0	Hz	10 = 1 Hz
26.56	Oscillation damping phase	<i>Real</i>	0...360	deg	1 = 1 deg
26.57	Oscillation damping gain	<i>Real</i>	0.0 ... 100.0	%	10 = 1%
26.58	Oscillation damping output	<i>Real</i>	-1600.000 ... 1600.000	%	1000 = 1%
26.70	Torque reference act 1	<i>Real</i>	-1600.0 ... 1600.0	%	10 = 1%
26.71	Torque reference act 2	<i>Real</i>	-1600.0 ... 1600.0	%	10 = 1%
26.72	Torque reference act 3	<i>Real</i>	-1600.0 ... 1600.0	%	10 = 1%
26.73	Torque reference act 4	<i>Real</i>	-1600.0 ... 1600.0	%	10 = 1%
26.74	Torque ref ramp out	<i>Real</i>	-1600.0 ... 1600.0	%	10 = 1%
26.75	Torque reference act 5	<i>Real</i>	-1600.0 ... 1600.0	%	10 = 1%
26.76	Torque reference act 6	<i>Real</i>	-1600.0 ... 1600.0	%	10 = 1%
26.77	Torque ref add A actual	<i>Real</i>	-1600.0 ... 1600.0	%	10 = 1%
26.78	Torque ref add B actual	<i>Real</i>	-1600.0 ... 1600.0	%	10 = 1%
26.81	Rush control gain	<i>Real</i>	0.0 ... 10000.0	-	10 = 1
26.82	Rush control integration time	<i>Real</i>	0.0 ... 10.0	s	10 = 1 s
28 Frequency reference chain					
28.01	Frequency ref ramp input	<i>Real</i>	-500.00 ... 500.00	Hz	100 = 1 Hz
28.02	Frequency ref ramp output	<i>Real</i>	-500.00 ... 500.00	Hz	100 = 1 Hz
28.11	Frequency ref1 source	<i>Analog src</i>	-	-	1 = 1
28.12	Frequency ref2 source	<i>Analog src</i>	-	-	1 = 1
28.13	Frequency ref1 function	<i>List</i>	0...5	-	1 = 1
28.14	Frequency ref1/2 selection	<i>Binary src</i>	-	-	1 = 1
28.21	Constant frequency function	<i>PB</i>	00b...11b	-	1 = 1
28.22	Constant frequency sel1	<i>Binary src</i>	-	-	1 = 1

No.	Name	Type	Range	Unit	FbEq32
28.23	Constant frequency sel2	<i>Binary src</i>	-	-	1 = 1
28.24	Constant frequency sel3	<i>Binary src</i>	-	-	1 = 1
28.26	Constant frequency 1	<i>Real</i>	-500.00 ... 500.00	Hz	100 = 1 Hz
28.27	Constant frequency 2	<i>Real</i>	-500.00 ... 500.00	Hz	100 = 1 Hz
28.28	Constant frequency 3	<i>Real</i>	-500.00 ... 500.00	Hz	100 = 1 Hz
28.29	Constant frequency 4	<i>Real</i>	-500.00 ... 500.00	Hz	100 = 1 Hz
28.30	Constant frequency 5	<i>Real</i>	-500.00 ... 500.00	Hz	100 = 1 Hz
28.31	Constant frequency 6	<i>Real</i>	-500.00 ... 500.00	Hz	100 = 1 Hz
28.32	Constant frequency 7	<i>Real</i>	-500.00 ... 500.00	Hz	100 = 1 Hz
28.41	Frequency ref safe	<i>Real</i>	-500.00 ... 500.00	Hz	100 = 1 Hz
28.51	Critical frequency function	<i>PB</i>	00b...11b	-	1 = 1
28.52	Critical frequency 1 low	<i>Real</i>	-500.00 ... 500.00	Hz	100 = 1 Hz
28.53	Critical frequency 1 high	<i>Real</i>	-500.00 ... 500.00	Hz	100 = 1 Hz
28.54	Critical frequency 2 low	<i>Real</i>	-500.00 ... 500.00	Hz	100 = 1 Hz
28.55	Critical frequency 2 high	<i>Real</i>	-500.00 ... 500.00	Hz	100 = 1 Hz
28.56	Critical frequency 3 low	<i>Real</i>	-500.00 ... 500.00	Hz	100 = 1 Hz
28.57	Critical frequency 3 high	<i>Real</i>	-500.00 ... 500.00	Hz	100 = 1 Hz
28.71	Freq ramp set selection	<i>Binary src</i>	-	-	1 = 1
28.72	Freq acceleration time 1	<i>Real</i>	0.000 ... 1800.000	s	1000 = 1 s
28.73	Freq deceleration time 1	<i>Real</i>	0.000 ... 1800.000	s	1000 = 1 s
28.74	Freq acceleration time 2	<i>Real</i>	0.000 ... 1800.000	s	1000 = 1 s
28.75	Freq deceleration time 2	<i>Real</i>	0.000 ... 1800.000	s	1000 = 1 s
28.76	Freq ramp in zero source	<i>Binary src</i>	-	-	1 = 1
28.77	Freq ramp hold	<i>Binary src</i>	-	-	1 = 1
28.78	Freq ramp output balancing	<i>Real</i>	-500.00 ... 500.00	Hz	100 = 1 Hz
28.79	Freq ramp out balancing enable	<i>Binary src</i>	-	-	1 = 1
28.90	Frequency ref act 1	<i>Real</i>	-500.00 ... 500.00	Hz	100 = 1 Hz
28.91	Frequency ref act 2	<i>Real</i>	-500.00 ... 500.00	Hz	100 = 1 Hz
28.92	Frequency ref act 3	<i>Real</i>	-500.00 ... 500.00	Hz	100 = 1 Hz
28.96	Frequency ref act 7	<i>Real</i>	-500.00 ... 500.00	Hz	100 = 1 Hz
28.97	Frequency ref unlimited	<i>Real</i>	-500.00 ... 500.00	Hz	100 = 1 Hz
30 Limits					
30.01	Limit word 1	<i>PB</i>	0000h...FFFFh	-	1 = 1
30.02	Torque limit status	<i>PB</i>	0000h...FFFFh	-	1 = 1
30.11	Minimum speed	<i>Real</i>	-30000.00 ... 30000.00	rpm	100 = 1 rpm
30.12	Maximum speed	<i>Real</i>	-30000.00 ... 30000.00	rpm	100 = 1 rpm
30.13	Minimum frequency	<i>Real</i>	-500.00 ... 500.00	Hz	100 = 1 Hz

456 Additional parameter data

No.	Name	Type	Range	Unit	FbEq32
30.14	Maximum frequency	<i>Real</i>	-500.00 ... 500.00	Hz	100 = 1 Hz
30.15	Maximum start current enable	<i>List</i>	0...1	-	1 = 1
30.16	Maximum start current	<i>Real</i>	0.00 ... 30000.00	A	100 = 1 A
30.17	Maximum current	<i>Real</i>	0.00 ... 30000.00	A	100 = 1 A
30.18	Minimum torque sel	<i>Binary src</i>	-	-	1 = 1
30.19	Minimum torque 1	<i>Real</i>	-1600.0 ... 0.0	%	10 = 1%
30.20	Maximum torque 1	<i>Real</i>	0.0 ... 1600.0	%	10 = 1%
30.21	Minimum torque 2 source	<i>Analog src</i>	-	-	1 = 1
30.22	Maximum torque 2 source	<i>Analog src</i>	-	-	1 = 1
30.23	Minimum torque 2	<i>Real</i>	-1600.0 ... 0.0	%	10 = 1%
30.24	Maximum torque 2	<i>Real</i>	0.0 ... 1600.0	%	10 = 1%
30.25	Maximum torque sel	<i>Binary src</i>	-	-	1 = 1
30.26	Power motoring limit	<i>Real</i>	0.00 ... 600.00	%	100 = 1%
30.27	Power generating limit	<i>Real</i>	-600.00 ... 0.00	%	100 = 1%
30.30	Overvoltage control	<i>List</i>	0...1	-	1 = 1
30.31	Undervoltage control	<i>List</i>	0...1	-	1 = 1
31 Fault functions					
31.01	External event 1 source	<i>Binary src</i>	-	-	1 = 1
31.02	External event 1 type	<i>List</i>	0...3	-	1 = 1
31.03	External event 2 source	<i>Binary src</i>	-	-	1 = 1
31.04	External event 2 type	<i>List</i>	0...3	-	1 = 1
31.05	External event 3 source	<i>Binary src</i>	-	-	1 = 1
31.06	External event 3 type	<i>List</i>	0...3	-	1 = 1
31.07	External event 4 source	<i>Binary src</i>	-	-	1 = 1
31.08	External event 4 type	<i>List</i>	0...3	-	1 = 1
31.09	External event 5 source	<i>Binary src</i>	-	-	1 = 1
31.10	External event 5 type	<i>List</i>	0...3	-	1 = 1
31.11	Fault reset selection	<i>Binary src</i>	-	-	1 = 1
31.12	Autoreset selection	<i>PB</i>	0000h...FFFFh	-	1 = 1
31.13	User selectable fault	<i>Real</i>	0000h...FFFFh	-	1 = 1
31.14	Number of trials	<i>Real</i>	0...5	-	1 = 1
31.15	Total trials time	<i>Real</i>	1.0 ... 600.0	s	10 = 1 s
31.16	Delay time	<i>Real</i>	0.0 ... 120.0	s	10 = 1 s
31.19	Motor phase loss	<i>List</i>	0...1	-	1 = 1

No.	Name	Type	Range	Unit	FbEq32
31.20	Earth fault	List	0...2	-	1 = 1
31.21	Supply phase loss	List	0...1	-	1 = 1
31.22	STO indication run/stop	List	0...5	-	1 = 1
31.23	Wiring or earth fault	List	0...1	-	1 = 1
31.24	Stall function	List	0...2	-	1 = 1
31.25	Stall current limit	Real	0.0 ... 1600.0	%	10 = 1%
31.26	Stall speed limit	Real	0.00 ... 10000.00	rpm	100 = 1 rpm
31.27	Stall frequency limit	Real	0.00 ... 500.00	Hz	100 = 1 Hz
31.28	Stall time	Real	0...3600	s	1 = 1 s
31.30	Overspeed trip margin	Real	0.00 ... 10000.00	rpm	100 = 1 rpm
31.32	Emergency ramp supervision	Real	0...300	%	1 = 1%
31.33	Emergency ramp supervision delay	Real	0...32767	s	1 = 1 s
31.35	Main fan fault function	List	0...2	-	1 = 1
31.36	Aux fan fault bypass	List	0...1	-	1 = 1
31.37	Ramp stop supervision	Real	0...300	%	1 = 1%
31.38	Ramp stop supervision delay	Real	0...32767	s	1 = 1 s
31.40	Disable warnings	PB	0000h...FFFFh	-	1 = 1
31.42	Overcurrent fault limit	Real	0.0 ... 30000.0	A	100 = 1 A
32 Supervision					
32.01	Supervision status	PB	000b...111b	-	1 = 1
32.05	Supervision 1 function	List	0...6	-	1 = 1
32.06	Supervision 1 action	List	0...2	-	1 = 1
32.07	Supervision 1 signal	Analog src	-	-	1 = 1
32.08	Supervision 1 filter time	Real	0.000 ... 30.000	s	1000 = 1 s
32.09	Supervision 1 low	Real	-21474830.00 ... 21474830.00	-	100 = 1
32.10	Supervision 1 high	Real	-21474830.00 ... 21474830.00	-	100 = 1
32.15	Supervision 2 function	List	0...6	-	1 = 1
32.16	Supervision 2 action	List	0...2	-	1 = 1
32.17	Supervision 2 signal	Analog src	-	-	1 = 1
32.18	Supervision 2 filter time	Real	0.000 ... 30.000	s	1000 = 1 s
32.19	Supervision 2 low	Real	-21474830.00 ... 21474830.00	-	100 = 1
32.20	Supervision 2 high	Real	-21474830.00 ... 21474830.00	-	100 = 1
32.25	Supervision 3 function	List	0...6	-	1 = 1
32.26	Supervision 3 action	List	0...2	-	1 = 1
32.27	Supervision 3 signal	Analog src	-	-	1 = 1
32.28	Supervision 3 filter time	Real	0.000 ... 30.000	s	1000 = 1 s

458 Additional parameter data

No.	Name	Type	Range	Unit	FbEq32
32.29	Supervision 3 low	<i>Real</i>	-21474830.00 ... 21474830.00	-	100 = 1
32.30	Supervision 3 high	<i>Real</i>	-21474830.00 ... 21474830.00	-	100 = 1
33 Generic timer & counter					
33.01	Counter status	<i>PB</i>	000000b...111111b	-	1 = 1
33.10	On-time 1 actual	<i>Real</i>	0...4294967295	s	1 = 1 s
33.11	On-time 1 warn limit	<i>Real</i>	0...4294967295	s	1 = 1 s
33.12	On-time 1 function	<i>PB</i>	00b...11b	-	1 = 1
33.13	On-time 1 source	<i>Binary src</i>	-	-	1 = 1
33.14	On-time 1 warn message	<i>List</i>	-	-	1 = 1
33.20	On-time 2 actual	<i>Real</i>	0...4294967295	s	1 = 1 s
33.21	On-time 2 warn limit	<i>Real</i>	0...4294967295	s	1 = 1 s
33.22	On-time 2 function	<i>PB</i>	00b...11b	-	1 = 1
33.23	On-time 2 source	<i>Binary src</i>	-	-	1 = 1
33.24	On-time 2 warn message	<i>List</i>	-	-	1 = 1
33.30	Edge counter 1 actual	<i>Real</i>	0...4294967295	-	1 = 1
33.31	Edge counter 1 warn limit	<i>Real</i>	0...4294967295	-	1 = 1
33.32	Edge counter 1 function	<i>PB</i>	0000b...1111b	-	1 = 1
33.33	Edge counter 1 source	<i>Binary src</i>	-	-	1 = 1
33.34	Edge counter 1 divider	<i>Real</i>	1...4294967295	-	1 = 1
33.35	Edge counter 1 warn message	<i>List</i>	-	-	1 = 1
33.40	Edge counter 2 actual	<i>Real</i>	0...4294967295	-	1 = 1
33.41	Edge counter 2 warn limit	<i>Real</i>	0...4294967295	-	1 = 1
33.42	Edge counter 2 function	<i>PB</i>	0000b...1111b	-	1 = 1
33.43	Edge counter 2 source	<i>Binary src</i>	-	-	1 = 1
33.44	Edge counter 2 divider	<i>Real</i>	1...4294967295	-	1 = 1
33.45	Edge counter 2 warn message	<i>List</i>	-	-	1 = 1
33.50	Value counter 1 actual	<i>Real</i>	-2147483008 ... 2147483008	-	1 = 1
33.51	Value counter 1 warn limit	<i>Real</i>	-2147483008 ... 2147483008	-	1 = 1
33.52	Value counter 1 function	<i>PB</i>	00b...11b	-	1 = 1
33.53	Value counter 1 source	<i>Analog src</i>	-	-	1 = 1
33.54	Value counter 1 divider	<i>Real</i>	0.001 ... 2147483.000	-	1000 = 1
33.55	Value counter 1 warn message	<i>List</i>	-	-	1 = 1
33.60	Value counter 2 actual	<i>Real</i>	-2147483008 ... 2147483008	-	1 = 1
33.61	Value counter 2 warn limit	<i>Real</i>	-2147483008 ... 2147483008	-	1 = 1

No.	Name	Type	Range	Unit	FbEq32
33.62	Value counter 2 function	<i>PB</i>	00b...11b	-	1 = 1
33.63	Value counter 2 source	<i>Analog src</i>	-	-	1 = 1
33.64	Value counter 2 divider	<i>Real</i>	0.001 ... 2147483.000	-	1000 = 1
33.65	Value counter 2 warn message	<i>List</i>	-	-	1 = 1
35 Motor thermal protection					
35.01	Motor estimated temperature	<i>Real</i>	-60 ... 1000	°C or °F	1 = 1°
35.02	Measured temperature 1	<i>Real</i>	-60 ... 5000 °C, -76 ... 9032 °F, 0 ohm or [35.12] ohm	°C, °F or ohm	1 = 1 unit
35.03	Measured temperature 2	<i>Real</i>	-60 ... 5000 °C, -76 ... 9032 °F, 0 ohm or [35.22] ohm	°C, °F or ohm	1 = 1 unit
35.11	Temperature 1 source	<i>List</i>	0...11	-	1 = 1
35.12	Temperature 1 fault limit	<i>Real</i>	-60 ... 5000 °C or ohm, or -76 ... 9032 °F	°C, °F or ohm	1 = 1 unit
35.13	Temperature 1 warning limit	<i>Real</i>	-60 ... 5000 °C or ohm, or -76 ... 9032 °F	°C, °F or ohm	1 = 1 unit
35.14	Temperature 1 AI source	<i>Analog src</i>	-	-	1 = 1
35.21	Temperature 2 source	<i>List</i>	0...11	-	1 = 1
35.22	Temperature 2 fault limit	<i>Real</i>	-60 ... 5000 °C or ohm, or -76 ... 9032 °F	°C, °F or ohm	1 = 1 unit
35.23	Temperature 2 warning limit	<i>Real</i>	-60 ... 5000 °C or ohm, or -76 ... 9032 °F	°C, °F or ohm	1 = 1 unit
35.24	Temperature 2 AI source	<i>Analog src</i>	-	-	1 = 1
35.50	Motor ambient temperature	<i>Real</i>	-60 ... 100 °C or -76 ... 212 °F	°C or °F	1 = 1°
35.51	Motor load curve	<i>Real</i>	50...150	%	1 = 1%
35.52	Zero speed load	<i>Real</i>	50...150	%	1 = 1%
35.53	Break point	<i>Real</i>	1.00 ... 500.00	Hz	100 = 1 Hz
35.54	Motor nominal temperature rise	<i>Real</i>	0...300 °C or 32...572 °F	°C or °F	1 = 1°
35.55	Motor thermal time constant	<i>Real</i>	100...10000	s	1 = 1 s
35.60	Cable temperature	<i>Real</i>	0.0 ... 200.0	%	10 = 1%
35.61	Cable nominal current	<i>Real</i>	0.00 ... 10000.0	A	100 = 1 A
35.62	Cable thermal rise time	<i>Real</i>	0...50000	s	1 = 1 s
35.100	DOL starter control source	<i>Binary src</i>	-	-	1 = 1
35.101	DOL starter on delay	<i>Real</i>	0...42949673	s	1 = 1 s
35.102	DOL starter off delay	<i>Real</i>	0...715828	min	1 = 1 min
35.103	DOL starter feedback source	<i>Binary src</i>	-	-	1 = 1
35.104	DOL starter feedback delay	<i>Real</i>	0...42949673	s	1 = 1 s
35.105	DOL starter status word	<i>PB</i>	0000b...1111b	-	1 = 1

460 Additional parameter data

No.	Name	Type	Range	Unit	FbEq32
35.106	DOL starter event type	List	0...2	-	1 = 1
36 Load analyzer					
36.01	PVL signal source	Analog src	-	-	1 = 1
36.02	PVL filter time	Real	0.00 ... 120.00	s	100 = 1 s
36.06	AL2 signal source	Analog src	-	-	1 = 1
36.07	AL2 signal scaling	Real	0.00 ... 32767.00	-	100 = 1
36.09	Reset loggers	List	0...3	-	1 = 1
36.10	PVL peak value	Real	-32768.00 ... 32767.00	-	100 = 1
36.11	PVL peak date	Data	-	-	1 = 1
36.12	PVL peak time	Data	-	-	1 = 1
36.13	PVL current at peak	Real	-32768.00 ... 32767.00	A	100 = 1 A
36.14	PVL DC voltage at peak	Real	0.00 ... 2000.00	V	100 = 1 V
36.15	PVL speed at peak	Real	-32768.00 ... 32767.00	rpm	100 = 1 rpm
36.16	PVL reset date	Data	-	-	1 = 1
36.17	PVL reset time	Data	-	-	1 = 1
36.20	AL1 0 to 10%	Real	0.00 ... 100.00	%	100 = 1%
36.21	AL1 10 to 20%	Real	0.00 ... 100.00	%	100 = 1%
36.22	AL1 20 to 30%	Real	0.00 ... 100.00	%	100 = 1%
36.23	AL1 30 to 40%	Real	0.00 ... 100.00	%	100 = 1%
36.24	AL1 40 to 50%	Real	0.00 ... 100.00	%	100 = 1%
36.25	AL1 50 to 60%	Real	0.00 ... 100.00	%	100 = 1%
36.26	AL1 60 to 70%	Real	0.00 ... 100.00	%	100 = 1%
36.27	AL1 70 to 80%	Real	0.00 ... 100.00	%	100 = 1%
36.28	AL1 80 to 90%	Real	0.00 ... 100.00	%	100 = 1%
36.29	AL1 over 90%	Real	0.00 ... 100.00	%	100 = 1%
36.40	AL2 0 to 10%	Real	0.00 ... 100.00	%	100 = 1%
36.41	AL2 10 to 20%	Real	0.00 ... 100.00	%	100 = 1%
36.42	AL2 20 to 30%	Real	0.00 ... 100.00	%	100 = 1%
36.43	AL2 30 to 40%	Real	0.00 ... 100.00	%	100 = 1%
36.44	AL2 40 to 50%	Real	0.00 ... 100.00	%	100 = 1%
36.45	AL2 50 to 60%	Real	0.00 ... 100.00	%	100 = 1%
36.46	AL2 60 to 70%	Real	0.00 ... 100.00	%	100 = 1%
36.47	AL2 70 to 80%	Real	0.00 ... 100.00	%	100 = 1%
36.48	AL2 80 to 90%	Real	0.00 ... 100.00	%	100 = 1%
36.49	AL2 over 90%	Real	0.00 ... 100.00	%	100 = 1%
36.50	AL2 reset date	Data	-	-	1 = 1
36.51	AL2 reset time	Data	-	-	1 = 1
43 Brake chopper					
43.01	Braking resistor temperature	Real	0.0 ... 120.0	%	10 = 1%
43.06	Brake chopper function	List	0...3	-	1 = 1

No.	Name	Type	Range	Unit	FbEq32
43.07	Brake chopper run enable	<i>Binary src</i>	-	-	1 = 1
43.08	Brake resistor thermal tc	<i>Real</i>	0...10000	s	1 = 1 s
43.09	Brake resistor Pmax cont	<i>Real</i>	0.00 ... 10000.00	kW	100 = 1 kW
43.10	Brake resistance	<i>Real</i>	0.0 ... 1000.0	ohm	10 = 1 ohm
43.11	Brake resistor fault limit	<i>Real</i>	0...150	%	1 = 1%
43.12	Brake resistor warning limit	<i>Real</i>	0...150	%	1 = 1%
44 Mechanical brake control					
44.01	Brake control status	<i>PB</i>	00000000b...11111111b	-	1 = 1
44.02	Brake torque memory	<i>Real</i>	-1600.0 ... 1600.0	%	10 = 1%
44.03	Brake open torque reference	<i>Real</i>	-1600.0 ... 1600.0	%	10 = 1%
44.06	Brake control enable	<i>Binary src</i>	-	-	1 = 1
44.07	Brake acknowledge selection	<i>Binary src</i>	-	-	1 = 1
44.08	Brake open delay	<i>Real</i>	0.00 ... 5.00	s	100 = 1 s
44.09	Brake open torque source	<i>Analog src</i>	-	-	1 = 1
44.10	Brake open torque	<i>Real</i>	-1000...1000	%	10 = 1%
44.11	Keep brake closed	<i>Binary src</i>	-	-	1 = 1
44.12	Brake close request	<i>Binary src</i>	-	-	1 = 1
44.13	Brake close delay	<i>Real</i>	0.00 ... 60.00	s	100 = 1 s
44.14	Brake close level	<i>Real</i>	0.0 ... 1000.0	rpm	100 = 1 rpm
44.15	Brake close level delay	<i>Real</i>	0.00 ... 10.00	s	100 = 1 s
44.16	Brake reopen delay	<i>Real</i>	0.00 ... 10.00	s	100 = 1 s
44.17	Brake fault function	<i>List</i>	0...2	-	1 = 1
44.18	Brake fault delay	<i>Real</i>	0.00 ... 60.00	s	100 = 1 s
45 Energy efficiency					
45.01	Saved GW hours	<i>Real</i>	0...65535	GWh	1 = 1 GWh
45.02	Saved MW hours	<i>Real</i>	0...999	MWh	1 = 1 MWh
45.03	Saved kW hours	<i>Real</i>	0.0 ... 999.0	kWh	10 = 1 kWh
45.05	Saved money x1000	<i>Real</i>	0...4294967295	thousand	1 = 1 thousand
45.06	Saved money	<i>Real</i>	0.00 ... 999.99	(selectable)	100 = 1 unit
45.08	CO2 reduction in kilotons	<i>Real</i>	0...65535	metric kiloton	1 = 1 metric kiloton
45.09	CO2 reduction in tons	<i>Real</i>	0.0 ... 999.9	metric ton	10 = 1 metric ton
45.11	Energy optimizer	<i>List</i>	0...1	-	1 = 1
45.12	Energy tariff 1	<i>Real</i>	0.000 ... 4294967.295	(selectable)	1000 = 1 unit
45.13	Energy tariff 2	<i>Real</i>	0.000 ... 4294967.295	(selectable)	1000 = 1 unit

462 Additional parameter data

No.	Name	Type	Range	Unit	FbEq32
45.14	Tariff selection	<i>Binary src</i>	-	-	1 = 1
45.17	Tariff currency unit	<i>List</i>	100...102	-	1 = 1
45.18	CO2 conversion factor	<i>Real</i>	0.000 ... 65.535	metric ton/ MWh	1000 = 1 metric ton/MWh
45.19	Comparison power	<i>Real</i>	0.0 ... 100000.0	kW	10 = 1 kW
45.21	Energy calculations reset	<i>List</i>	0...1	-	1 = 1
46 Monitoring/scaling settings					
46.01	Speed scaling	<i>Real</i>	0.10 ... 30000.00	rpm	100 = 1 rpm
46.02	Frequency scaling	<i>Real</i>	0.10 ... 1000.00	Hz	100 = 1 Hz
46.03	Torque scaling	<i>Real</i>	0.1 ... 1000.0	%	10 = 1%
46.04	Power scaling	<i>Real</i>	0.10 ... 30000.00 kW or 0.10 ... 40214.48 hp	kW or hp	100 = 1 unit
46.05	Current scaling	<i>Real</i>	0...30000	A	1 = 1 A
46.06	Speed ref zero scaling	<i>Real</i>	0.00 ... 30000.00	rpm	100 = 1 rpm
46.07	Frequency ref zero scaling	<i>Real</i>	0.00 ... 1000.00	Hz	100 = 1 Hz
46.11	Filter time motor speed	<i>Real</i>	0...20000	ms	1 = 1 ms
46.12	Filter time output frequency	<i>Real</i>	0...20000	ms	1 = 1 ms
46.13	Filter time motor torque	<i>Real</i>	0...20000	ms	1 = 1 ms
46.14	Filter time power out	<i>Real</i>	0...20000	ms	1 = 1 ms
46.21	At speed hysteresis	<i>Real</i>	0.00 ... 30000.00	rpm	100 = 1 rpm
46.22	At frequency hysteresis	<i>Real</i>	0.00 ... 1000.00	Hz	100 = 1 Hz
46.23	At torque hysteresis	<i>Real</i>	0.0 ... 300.0	%	1 = 1%
46.31	Above speed limit	<i>Real</i>	0.00 ... 30000.00	rpm	100 = 1 rpm
46.32	Above frequency limit	<i>Real</i>	0.00 ... 1000.00	Hz	100 = 1 Hz
46.33	Above torque limit	<i>Real</i>	0.0 ... 1600.0	%	10 = 1%
46.42	Torque decimals	<i>List</i>	0...2	-	1 = 1
47 Data storage					
47.01	Data storage 1 real32	<i>Real</i>	Defined by 47.31	-	1000 = 1
47.02	Data storage 2 real32	<i>Real</i>	Defined by 47.32	-	1000 = 1
47.03	Data storage 3 real32	<i>Real</i>	Defined by 47.33	-	1000 = 1
47.04	Data storage 4 real32	<i>Real</i>	Defined by 47.34	-	1000 = 1
47.05	Data storage 5 real32	<i>Real</i>	Defined by 47.35	-	1000 = 1
47.06	Data storage 6 real32	<i>Real</i>	Defined by 47.36	-	1000 = 1
47.07	Data storage 7 real32	<i>Real</i>	Defined by 47.37	-	1000 = 1
47.08	Data storage 8 real32	<i>Real</i>	Defined by 47.38	-	1000 = 1
47.11	Data storage 1 int32	<i>Real</i>	-2147483648 ... 2147483647	-	1 = 1
47.12	Data storage 2 int32	<i>Real</i>	-2147483648 ... 2147483647	-	1 = 1
47.13	Data storage 3 int32	<i>Real</i>	-2147483648 ... 2147483647	-	1 = 1

No.	Name	Type	Range	Unit	FbEq32
47.14	Data storage 4 int32	<i>Real</i>	-2147483648 ... 2147483647	-	1 = 1
47.15	Data storage 5 int32	<i>Real</i>	-2147483648 ... 2147483647	-	1 = 1
47.16	Data storage 6 int32	<i>Real</i>	-2147483648 ... 2147483647	-	1 = 1
47.17	Data storage 7 int32	<i>Real</i>	-2147483648 ... 2147483647	-	1 = 1
47.18	Data storage 8 int32	<i>Real</i>	-2147483648 ... 2147483647	-	1 = 1
47.21	Data storage 1 int16	<i>Real</i>	-32768 ... 32767	-	1 = 1
47.22	Data storage 2 int16	<i>Real</i>	-32768 ... 32767	-	1 = 1
47.23	Data storage 3 int16	<i>Real</i>	-32768 ... 32767	-	1 = 1
47.24	Data storage 4 int16	<i>Real</i>	-32768 ... 32767	-	1 = 1
47.25	Data storage 5 int16	<i>Real</i>	-32768 ... 32767	-	1 = 1
47.26	Data storage 6 int16	<i>Real</i>	-32768 ... 32767	-	1 = 1
47.27	Data storage 7 int16	<i>Real</i>	-32768 ... 32767	-	1 = 1
47.28	Data storage 8 int16	<i>Real</i>	-32768 ... 32767	-	1 = 1
47.31	Data storage 1 real32 type	<i>List</i>	0...5	-	1 = 1
47.32	Data storage 2 real32 type	<i>List</i>	0...5	-	1 = 1
47.33	Data storage 3 real32 type	<i>List</i>	0...5	-	1 = 1
47.34	Data storage 4 real32 type	<i>List</i>	0...5	-	1 = 1
47.35	Data storage 5 real32 type	<i>List</i>	0...5	-	1 = 1
47.36	Data storage 6 real32 type	<i>List</i>	0...5	-	1 = 1
47.37	Data storage 7 real32 type	<i>List</i>	0...5	-	1 = 1
47.38	Data storage 8 real32 type	<i>List</i>	0...5	-	1 = 1
49 Panel port communication					
49.01	Node ID number	<i>Real</i>	1...32	-	1 = 1
49.03	Baud rate	<i>List</i>	1...5	-	1 = 1
49.04	Communication loss time	<i>Real</i>	0.3 ... 3000.0	s	10 = 1 s
49.05	Communication loss action	<i>List</i>	0...5	-	1 = 1
49.06	Refresh settings	<i>List</i>	0...1	-	1 = 1
49.07	Panel comm supervision force	<i>PB</i>	0000h...FFFFh	-	1 = 1
49.08	Secondary comm. loss action	<i>List</i>	0...5	-	1 = 1
49.14	Panel speed reference unit	<i>List</i>	0...1	-	1 = 1
49.15	Minimum speed ref panel	<i>Real</i>	-30000.00 ... 30000.00	-	100 = 1
49.16	Maximum speed ref panel	<i>Real</i>	-30000.00 ... 30000.00	-	100 = 1
49.17	Minimum frequency ref panel	<i>Real</i>	-500.00 ... 500.00	Hz	100 = 1 Hz
49.18	Maximum frequency ref panel	<i>Real</i>	-500.00 ... 500.00	Hz	100 = 1 Hz
50 Fieldbus adapter (FBA)					
50.01	FBA A enable	<i>List</i>	0...3	-	1 = 1
50.02	FBA A comm loss func	<i>List</i>	0...5	-	1 = 1
50.03	FBA A comm loss t out	<i>Real</i>	0.3 ... 6553.5	s	10 = 1 s

464 Additional parameter data

No.	Name	Type	Range	Unit	FbEq32
50.04	FBA A ref1 type	List	0...5	-	1 = 1
50.05	FBA A ref2 type	List	0...5	-	1 = 1
50.07	FBA A actual 1 type	List	0...6	-	1 = 1
50.08	FBA A actual 2 type	List	0...6	-	1 = 1
50.09	FBA A SW transparent source	Analog src	-	-	1 = 1
50.10	FBA A act1 transparent source	Analog src	-	-	1 = 1
50.11	FBA A act2 transparent source	Analog src	-	-	1 = 1
50.12	FBA A debug mode	List	0...1	-	1 = 1
50.13	FBA A control word	Data	00000000h ... FFFFFFFFh	-	1 = 1
50.14	FBA A reference 1	Real	-2147483648 ... 2147483647	-	1 = 1
50.15	FBA A reference 2	Real	-2147483648 ... 2147483647	-	1 = 1
50.16	FBA A status word	Data	00000000h ... FFFFFFFFh	-	1 = 1
50.17	FBA A actual value 1	Real	-2147483648 ... 2147483647	-	1 = 1
50.18	FBA A actual value 2	Real	-2147483648 ... 2147483647	-	1 = 1
50.21	FBA A timelevel sel	List	0...3	-	1 = 1
50.26	FBA A comm supervision force	PB	0000h...FFFFh	-	1 = 1
50.31	FBA B enable	List	0...1	-	1 = 1
50.32	FBA B comm loss func	Real	0...5	-	1 = 1
50.33	FBA B comm loss timeout	List	0.3 ... 6553.5	s	10 = 1 s
50.34	FBA B ref1 type	List	0...5	-	1 = 1
50.35	FBA B ref2 type	List	0...5	-	1 = 1
50.37	FBA B actual 1 type	List	0...6	-	1 = 1
50.38	FBA B actual 2 type	List	0...6	-	1 = 1
50.39	FBA B SW transparent source	Analog src	-	-	1 = 1
50.40	FBA B act1 transparent source	Analog src	-	-	1 = 1
50.41	FBA B act2 transparent source	List	-	-	1 = 1
50.42	FBA B debug mode	Data	0...1	-	1 = 1
50.43	FBA B control word	Real	00000000h ... FFFFFFFFh	-	1 = 1
50.44	FBA B reference 1	Real	-2147483648 ... 2147483647	-	1 = 1
50.45	FBA B reference 2	Data	-2147483648 ... 2147483647	-	1 = 1
50.46	FBA B status word	Real	00000000h ... FFFFFFFFh	-	1 = 1
50.47	FBA B actual value 1	Real	-2147483648 ... 2147483647	-	1 = 1

No.	Name	Type	Range	Unit	FbEq32
50.48	FBA B actual value 2		-2147483648 ... 2147483647	-	1 = 1
50.51	FBA B timelevel sel	List	0...3	-	1 = 1
50.56	FBA B comm supervision force	PB	0000h...FFFFh	-	1 = 1
51 FBA A settings					
51.01	FBA A type	List	-	-	1 = 1
51.02	FBA A Par2	Real	0...65535	-	1 = 1
...	
51.26	FBA A Par26	Real	0...65535	-	1 = 1
51.27	FBA A par refresh	List	0...1	-	1 = 1
51.28	FBA A par table ver	Data	-	-	1 = 1
51.29	FBA A drive type code	Real	0...65535	-	1 = 1
51.30	FBA A mapping file ver	Real	0...65535	-	1 = 1
51.31	D2FBA A comm status	List	0...6	-	1 = 1
51.32	FBA A comm SW ver	Data	-	-	1 = 1
51.33	FBA A appl SW ver	Data	-	-	1 = 1
52 FBA A data in					
52.01	FBA A data in1	List	-	-	1 = 1
...	
52.12	FBA A data in12	List	-	-	1 = 1
53 FBA A data out					
53.01	FBA A data out1	List	-	-	1 = 1
...	
53.12	FBA A data out12	List	-	-	1 = 1
54 FBA B settings					
54.01	FBA B type				
54.02	FBA B Par2	UINT16	0...65535	-	
...	
54.26	FBA B Par26	UINT16	0...65535	-	
54.27	FBA B par refresh	List	0...1	-	
54.28	FBA B par table ver	UINT16	0...65535	-	
54.29	FBA B drive type code	UINT16	0...65535	-	
54.30	FBA B mapping file ver	UINT16	0...65535	-	
54.31	D2FBA B comm status	List	0...6	-	
54.32	FBA B comm SW ver	UINT16	0...65535	-	
54.33	FBA B appl SW ver	UINT16	0...65535	-	
55 FBA B data in					
55.01	FBA B data in1	List	-	-	1 = 1
...	
55.12	FBA B data in12	List	-	-	1 = 1

466 Additional parameter data

No.	Name	Type	Range	Unit	FbEq32
56 FBA B data out					
56.01	FBA B data out1	List	-	-	1 = 1
...	
56.12	FBA B data out12	List	-	-	1 = 1
58 Embedded fieldbus					
58.01	Protocol enable	List	0...1	-	1 = 1
58.02	Protocol ID	Real	0000h...FFFFh	-	1 = 1
58.03	Node address	Real	0...255	-	1 = 1
58.04	Baud rate	List	2...7	-	1 = 1
58.05	Parity	List	0...3	-	1 = 1
58.06	Communication control	List	0...2	-	1 = 1
58.07	Communication diagnostics	PB	0000h...FFFFh	-	1 = 1
58.08	Received packets	Real	0...4294967295	-	1 = 1
58.09	Transmitted packets	Real	0...4294967295	-	1 = 1
58.10	All packets	Real	0...4294967295	-	1 = 1
58.11	UART errors	Real	0...4294967295	-	1 = 1
58.12	CRC errors	Real	0...4294967295	-	1 = 1
58.14	Communication loss action	List	0...5	-	1 = 1
58.15	Communication loss mode	List	1...2	-	1 = 1
58.16	Communication loss time	Real	0.0 ... 6000.0	s	10 = 1 s
58.17	Transmit delay	Real	0...65535	ms	1 = 1 ms
58.18	EFB control word	PB	0000h...FFFFh	-	1 = 1
58.19	EFB status word	PB	0000h...FFFFh	-	1 = 1
58.25	Control profile	List	0, 2	-	1 = 1
58.26	EFB ref1 type	List	0...5	-	1 = 1
58.27	EFB ref2 type	List	0...5	-	1 = 1
58.28	EFB act1 type	List	0...6	-	1 = 1
58.29	EFB act2 type	List	0...6	-	1 = 1
58.30	EFB status word transparent source	Analog src	-	-	1 = 1
58.31	EFB act1 transparent source	Analog src	-	-	1 = 1
58.32	EFB act2 transparent source	Analog src	-	-	1 = 1
58.33	Addressing mode	List	0...2	-	1 = 1
58.34	Word order	List	0...1	-	1 = 1
58.36	EFB comm supervision force	PB	0000h...FFFFh	-	1 = 1
58.101	Data I/O 1	Analog src	-	-	1 = 1
58.102	Data I/O 2	Analog src	-	-	1 = 1
58.103	Data I/O 3	Analog src	-	-	1 = 1

No.	Name	Type	Range	Unit	FbEq32
58.104	Data I/O 4	<i>Analog src</i>	-	-	1 = 1
58.105	Data I/O 5	<i>Analog src</i>	-	-	1 = 1
58.106	Data I/O 6	<i>Analog src</i>	-	-	1 = 1
58.107	Data I/O 7	<i>Analog src</i>	-	-	1 = 1
...	
58.124	Data I/O 24	<i>Analog src</i>	-	-	1 = 1
60 DDCS communication					
60.01	M/F communication port	<i>List</i>	-	-	-
60.02	M/F node address	<i>Real</i>	1...254	-	-
60.03	M/F mode	<i>List</i>	0...6	-	-
60.05	M/F HW connection	<i>List</i>	0...1	-	-
60.07	M/F link control	<i>Real</i>	1...15	-	-
60.08	M/F comm loss timeout	<i>Real</i>	0...65535	ms	-
60.09	M/F comm loss function	<i>List</i>	0...3	-	-
60.10	M/F ref1 type	<i>List</i>	0...5	-	-
60.11	M/F ref2 type	<i>List</i>	0...5	-	-
60.12	M/F act1 type	<i>List</i>	0...5	-	-
60.13	M/F act2 type	<i>List</i>	0...5	-	-
60.14	M/F follower selection	<i>Real</i>	0...16	-	-
60.15	Force master	<i>Binary src</i>	-	-	1 = 1
60.16	Force follower	<i>Binary src</i>	-	-	1 = 1
60.17	Follower fault action	<i>List</i>	0...2	-	-
60.18	Follower enable	<i>List</i>	0...6	-	-
60.19	M/F comm supervision sel 1	<i>PB</i>	0000h...FFFFh	-	1 = 1
60.20	M/F comm supervision sel 2	<i>PB</i>	0000h...FFFFh	-	1 = 1
60.23	M/F status supervision sel 1	<i>PB</i>	0000h...FFFFh	-	1 = 1
60.24	M/F status supervision sel 2	<i>PB</i>	0000h...FFFFh	-	1 = 1
60.27	M/F status supv mode sel 1	<i>PB</i>	0000h...FFFFh	-	1 = 1
60.28	M/F status supv mode sel 2	<i>PB</i>	0000h...FFFFh	-	1 = 1
60.31	M/F wake up delay	<i>Real</i>	0.0 ... 180.0	s	10 = 1 s
60.32	M/F comm supervision force	<i>PB</i>	0000h...FFFFh	-	1 = 1
61 D2D and DDCS transmit data					
61.01	M/F data 1 selection	<i>List</i>	-	-	-
61.02	M/F data 2 selection	<i>List</i>	-	-	-
61.03	M/F data 3 selection	<i>List</i>	-	-	-
61.25	M/F data 1 value	<i>Real</i>	0...65535	-	-

468 *Additional parameter data*

No.	Name	Type	Range	Unit	FbEq32
61.26	M/F data 2 value	<i>Real</i>	0...65535	-	-
61.27	M/F data 3 value	<i>Real</i>	0...65535	-	-
61.45	Data set 2 data 1 selection	<i>List</i>	-	-	-
61.46	Data set 2 data 2 selection	<i>List</i>	-	-	-
61.47	Data set 2 data 3 selection	<i>List</i>	-	-	-
61.48	Data set 4 data 1 selection	<i>List</i>	-	-	-
61.49	Data set 4 data 2 selection	<i>List</i>	-	-	-
61.50	Data set 4 data 3 selection	<i>List</i>	-	-	-
61.51	Data set 11 data 1 selection	<i>List</i>	-	-	-
61.52	Data set 11 data 2 selection	<i>List</i>	-	-	-
61.53	Data set 11 data 3 selection	<i>List</i>	-	-	-
61.54	Data set 13 data 1 selection	<i>List</i>	-	-	-
61.55	Data set 13 data 2 selection	<i>List</i>	-	-	-
61.56	Data set 13 data 3 selection	<i>List</i>	-	-	-
61.57	Data set 15 data 1 selection	<i>List</i>	-	-	-
61.58	Data set 15 data 2 selection	<i>List</i>	-	-	-
61.59	Data set 15 data 3 selection	<i>List</i>	-	-	-
61.60	Data set 17 data 1 selection	<i>List</i>	-	-	-
61.61	Data set 17 data 2 selection	<i>List</i>	-	-	-
61.62	Data set 17 data 3 selection	<i>List</i>	-	-	-
61.63	Data set 19 data 1 selection	<i>List</i>	-	-	-
61.64	Data set 19 data 2 selection	<i>List</i>	-	-	-
61.65	Data set 19 data 3 selection	<i>List</i>	-	-	-
61.66	Data set 21 data 1 selection	<i>List</i>	-	-	-
61.67	Data set 21 data 2 selection	<i>List</i>	-	-	-
61.68	Data set 21 data 3 selection	<i>List</i>	-	-	-
61.69	Data set 23 data 1 selection	<i>List</i>	-	-	-
61.70	Data set 23 data 2 selection	<i>List</i>	-	-	-
61.71	Data set 23 data 3 selection	<i>List</i>	-	-	-
61.72	Data set 25 data 1 selection	<i>List</i>	-	-	-
61.73	Data set 25 data 2 selection	<i>List</i>	-	-	-
61.74	Data set 25 data 3 selection	<i>List</i>	-	-	-
61.95	Data set 2 data 1 value	<i>Real</i>	0...65535	-	-
61.96	Data set 2 data 2 value	<i>Real</i>	0...65535	-	-
61.97	Data set 2 data 3 value	<i>Real</i>	0...65535	-	-
61.98	Data set 4 data 1 value	<i>Real</i>	0...65535	-	-
61.99	Data set 4 data 2 value	<i>Real</i>	0...65535	-	-
61.100	Data set 4 data 3 value	<i>Real</i>	0...65535	-	-
61.101	Data set 11 data 1 value	<i>Real</i>	0...65535	-	-
61.102	Data set 11 data 2 value	<i>Real</i>	0...65535	-	-
61.103	Data set 11 data 3 value	<i>Real</i>	0...65535	-	-

No.	Name	Type	Range	Unit	FbEq32
61.104	Data set 13 data 1 value	<i>Real</i>	0...65535	-	-
61.105	Data set 13 data 2 value	<i>Real</i>	0...65535	-	-
61.106	Data set 13 data 3 value	<i>Real</i>	0...65535	-	-
61.107	Data set 15 data 1 value	<i>Real</i>	0...65535	-	-
61.108	Data set 15 data 2 value	<i>Real</i>	0...65535	-	-
61.109	Data set 15 data 3 value	<i>Real</i>	0...65535	-	-
61.110	Data set 17 data 1 value	<i>Real</i>	0...65535	-	-
61.111	Data set 17 data 2 value	<i>Real</i>	0...65535	-	-
61.112	Data set 17 data 3 value	<i>Real</i>	0...65535	-	-
61.113	Data set 19 data 1 value	<i>Real</i>	0...65535	-	-
61.114	Data set 19 data 2 value	<i>Real</i>	0...65535	-	-
61.115	Data set 19 data 3 value	<i>Real</i>	0...65535	-	-
61.116	Data set 21 data 1 value	<i>Real</i>	0...65535	-	-
61.117	Data set 21 data 2 value	<i>Real</i>	0...65535	-	-
61.118	Data set 21 data 3 value	<i>Real</i>	0...65535	-	-
61.119	Data set 23 data 1 value	<i>Real</i>	0...65535	-	-
61.120	Data set 23 data 2 value	<i>Real</i>	0...65535	-	-
61.121	Data set 23 data 3 value	<i>Real</i>	0...65535	-	-
61.122	Data set 25 data 1 value	<i>Real</i>	0...65535	-	-
61.123	Data set 25 data 2 value	<i>Real</i>	0...65535	-	-
61.124	Data set 25 data 3 value	<i>Real</i>	0...65535	-	-
62 D2D and DDCS receive data					
62.01	M/F data 1 selection	<i>List</i>	-	-	-
62.02	M/F data 2 selection	<i>List</i>	-	-	-
62.03	M/F data 3 selection	<i>List</i>	-	-	-
62.04	Follower node 2 data 1 sel	<i>List</i>	-	-	-
62.05	Follower node 2 data 2 sel	<i>List</i>	-	-	-
62.06	Follower node 2 data 3 sel	<i>List</i>	-	-	-
62.07	Follower node 3 data 1 sel	<i>List</i>	-	-	-
62.08	Follower node 3 data 2 sel	<i>List</i>	-	-	-
62.09	Follower node 3 data 3 sel	<i>List</i>	-	-	-
62.10	Follower node 4 data 1 sel	<i>List</i>	-	-	-
62.11	Follower node 4 data 2 sel	<i>List</i>	-	-	-
62.12	Follower node 4 data 3 sel	<i>List</i>	-	-	-
62.25	MF data 1 value	<i>Real</i>	0...65535	-	-
62.26	MF data 2 value	<i>Real</i>	0...65535	-	-
62.27	MF data 3 value	<i>Real</i>	0...65535	-	-
62.28	Follower node 2 data 1 value	<i>Real</i>	0...65535	-	-
62.29	Follower node 2 data 2 value	<i>Real</i>	0...65535	-	-
62.30	Follower node 2 data 3 value	<i>Real</i>	0...65535	-	-

470 Additional parameter data

No.	Name	Type	Range	Unit	FbEq32
62.31	Follower node 3 data 1 value	<i>Real</i>	0...65535	-	-
62.32	Follower node 3 data 2 value	<i>Real</i>	0...65535	-	-
62.33	Follower node 3 data 3 value	<i>Real</i>	0...65535	-	-
62.34	Follower node 4 data 1 value	<i>Real</i>	0...65535	-	-
62.35	Follower node 4 data 2 value	<i>Real</i>	0...65535	-	-
62.36	Follower node 4 data 3 value	<i>Real</i>	0...65535	-	-
62.37	M/F communication status 1	<i>PB</i>	0000h...FFFFh	-	1 = 1
62.38	M/F communication status 2	<i>PB</i>	0000h...FFFFh	-	1 = 1
62.41	M/F follower ready status 1	<i>PB</i>	0000h...FFFFh	-	1 = 1
62.42	M/F follower ready status 2	<i>PB</i>	0000h...FFFFh	-	1 = 1
62.45	Data set 1 data 1 selection	<i>List</i>	-	-	-
62.46	Data set 1 data 2 selection	<i>List</i>	-	-	-
62.47	Data set 1 data 3 selection	<i>List</i>	-	-	-
62.48	Data set 3 data 1 selection	<i>List</i>	-	-	-
62.49	Data set 3 data 2 selection	<i>List</i>	-	-	-
62.50	Data set 3 data 3 selection	<i>List</i>	-	-	-
62.51	Data set 10 data 1 selection	<i>List</i>	-	-	-
62.52	Data set 10 data 2 selection	<i>List</i>	-	-	-
62.53	Data set 10 data 3 selection	<i>List</i>	-	-	-
62.54	Data set 12 data 1 selection	<i>List</i>	-	-	-
62.55	Data set 12 data 2 selection	<i>List</i>	-	-	-
62.56	Data set 12 data 3 selection	<i>List</i>	-	-	-
62.57	Data set 14 data 1 selection	<i>List</i>	-	-	-
62.58	Data set 14 data 2 selection	<i>List</i>	-	-	-
62.59	Data set 14 data 3 selection	<i>List</i>	-	-	-
62.60	Data set 16 data 1 selection	<i>List</i>	-	-	-
62.61	Data set 16 data 2 selection	<i>List</i>	-	-	-
62.62	Data set 16 data 3 selection	<i>List</i>	-	-	-
62.63	Data set 18 data 1 selection	<i>List</i>	-	-	-
62.64	Data set 18 data 2 selection	<i>List</i>	-	-	-
62.65	Data set 18 data 3 selection	<i>List</i>	-	-	-
62.66	Data set 20 data 1 selection	<i>List</i>	-	-	-
62.67	Data set 20 data 2 selection	<i>List</i>	-	-	-
62.68	Data set 20 data 3 selection	<i>List</i>	-	-	-
62.69	Data set 22 data 1 selection	<i>List</i>	-	-	-
62.70	Data set 22 data 2 selection	<i>List</i>	-	-	-
62.71	Data set 22 data 3 selection	<i>List</i>	-	-	-
62.72	Data set 24 data 1 selection	<i>List</i>	-	-	-
62.73	Data set 24 data 2 selection	<i>List</i>	-	-	-
62.74	Data set 24 data 3 selection	<i>List</i>	-	-	-
62.95	Data set 1 data 1 value	<i>Real</i>	0...65535	-	-

No.	Name	Type	Range	Unit	FbEq32
62.96	Data set 1 data 2 value	<i>Real</i>	0...65535	-	-
62.97	Data set 1 data 3 value	<i>Real</i>	0...65535	-	-
62.98	Data set 3 data 1 value	<i>Real</i>	0...65535	-	-
62.99	Data set 3 data 2 value	<i>Real</i>	0...65535	-	-
62.100	Data set 3 data 3 value	<i>Real</i>	0...65535	-	-
62.101	Data set 10 data 1 value	<i>Real</i>	0...65535	-	-
62.102	Data set 10 data 2 value	<i>Real</i>	0...65535	-	-
62.103	Data set 10 data 3 value	<i>Real</i>	0...65535	-	-
62.104	Data set 12 data 1 value	<i>Real</i>	0...65535	-	-
62.105	Data set 12 data 2 value	<i>Real</i>	0...65535	-	-
62.106	Data set 12 data 3 value	<i>Real</i>	0...65535	-	-
62.107	Data set 14 data 1 value	<i>Real</i>	0...65535	-	-
62.108	Data set 14 data 2 value	<i>Real</i>	0...65535	-	-
62.109	Data set 14 data 3 value	<i>Real</i>	0...65535	-	-
62.110	Data set 16 data 1 value	<i>Real</i>	0...65535	-	-
62.111	Data set 16 data 2 value	<i>Real</i>	0...65535	-	-
62.112	Data set 16 data 3 value	<i>Real</i>	0...65535	-	-
62.113	Data set 18 data 1 value	<i>Real</i>	0...65535	-	-
62.114	Data set 18 data 2 value	<i>Real</i>	0...65535	-	-
62.115	Data set 18 data 3 value	<i>Real</i>	0...65535	-	-
62.116	Data set 20 data 1 value	<i>Real</i>	0...65535	-	-
62.117	Data set 20 data 2 value	<i>Real</i>	0...65535	-	-
62.118	Data set 20 data 3 value	<i>Real</i>	0...65535	-	-
62.119	Data set 22 data 1 value	<i>Real</i>	0...65535	-	-
62.120	Data set 22 data 2 value	<i>Real</i>	0...65535	-	-
62.121	Data set 22 data 3 value	<i>Real</i>	0...65535	-	-
62.122	Data set 24 data 1 value	<i>Real</i>	0...65535	-	-
62.123	Data set 24 data 2 value	<i>Real</i>	0...65535	-	-
62.124	Data set 24 data 3 value	<i>Real</i>	0...65535	-	-
90 Feedback selection					
90.01	Motor speed for control	<i>Real</i>	-32768.00 ... 32767.00	rpm	100 = 1 rpm
90.02	Motor position	<i>Real</i>	0.00000000 ... 1.00000000	rev	100000000 = 1 rev
90.03	Load speed	<i>Real</i>	-32768.00 ... 32767.00	rpm	100 = 1 rpm
90.04	Load position	<i>Real</i>	-2147483648 ... 2147483647	-	1 = 1
90.05	Load position scaled	<i>Real</i>	-2147483.648 ... 2147483.647	-	100000 = 1
90.06	Motor position scaled	<i>Real</i>	-2147483.648 ... 2147483.647	-	1000 = 1
90.07	Load position scaled int	<i>Real</i>	-2147483648 ... 2147483647	-	1 = 1
90.10	Encoder 1 speed	<i>Real</i>	-32768.00 ... 32767.00	rpm	100 = 1 rpm

472 Additional parameter data

No.	Name	Type	Range	Unit	FbEq32
90.11	Encoder 1 position	<i>Real</i>	0.00000000 ... 1.00000000	rev	100000000 = 1 rev
90.12	Encoder 1 multiturn revolutions	<i>Real</i>	0...16777215	-	1 = 1
90.13	Encoder 1 revolution extension	<i>Real</i>	-2147483648 ... 2147483647	-	1 = 1
90.14	Encoder 1 position raw	<i>Real</i>	0...16777215	-	1 = 1
90.15	Encoder 1 revolutions raw	<i>Real</i>	0...16777215	-	1 = 1
90.20	Encoder 2 speed	<i>Real</i>	-32768.00 ... 32767.00	rpm	100 = 1 rpm
90.21	Encoder 2 position	<i>Real</i>	0.00000000 ... 1.00000000	rev	100000000 = 1 rev
90.22	Encoder 2 multiturn revolutions	<i>Real</i>	0...16777215	-	1 = 1
90.23	Encoder 2 revolution extension	<i>Real</i>	-2147483648 ... 2147483647	-	1 = 1
90.24	Encoder 2 position raw	<i>Real</i>	0...16777215	-	1 = 1
90.25	Encoder 2 revolutions raw	<i>Real</i>	0...16777215	-	1 = 1
90.26	Motor revolution extension	<i>Real</i>	-2147483648 ... 2147483647	-	1 = 1
90.27	Load revolution extension	<i>Real</i>	-2147483648 ... 2147483647	-	1 = 1
90.35	Pos counter status	<i>PB</i>	000000b...111111b	-	1 = 1
90.38	Pos counter decimals	<i>List</i>	0...9	-	1 = 1
90.41	Motor feedback selection	<i>List</i>	0...2	-	1 = 1
90.42	Motor speed filter time	<i>Real</i>	0...10000	ms	1 = 1 ms
90.43	Motor gear numerator	<i>Real</i>	-32768...32767	-	1 = 1
90.44	Motor gear denominator	<i>Real</i>	-32768...32767	-	1 = 1
90.45	Motor feedback fault	<i>List</i>	0...1	-	1 = 1
90.46	Force open loop	<i>List</i>	0...1	-	1 = 1
90.48	Motor position axis mode	<i>List</i>	0...1	-	1 = 1
90.49	Motor position resolution	<i>Real</i>	0...31	-	1 = 1
90.51	Load feedback selection	<i>List</i>	0...4	-	1 = 1
90.52	Load speed filter time	<i>Real</i>	0...10000	ms	1 = 1 ms
90.53	Load gear numerator	<i>Real</i>	-2147483648 ... 2147483647	-	1 = 1
90.54	Load gear denominator	<i>Real</i>	-2147483648 ... 2147483647	-	1 = 1
90.55	Load feedback fault	<i>List</i>	0...1	-	1 = 1
90.56	Load position offset	<i>Real</i>	-2147483648 ... 2147483647	rev	1 = 1 rev
90.57	Load position resolution	<i>Real</i>	0...31	-	1 = 1
90.58	Pos counter init value int	<i>Real</i>	-2147483648 ... 2147483647	-	1 = 1
90.59	Pos counter init value int source	<i>Binary src</i>	-	-	1 = 1

No.	Name	Type	Range	Unit	FbEq32
90.61	Gear numerator	<i>Real</i>	-2147483648 ... 2147483647	-	1 = 1
90.62	Gear denominator	<i>Real</i>	-2147483648 ... 2147483647	-	1 = 1
90.63	Feed constant numerator	<i>Real</i>	-2147483648 ... 2147483647	-	1 = 1
90.64	Feed constant denominator	<i>Real</i>	-2147483648 ... 2147483647	-	1 = 1
90.65	Pos counter init value	<i>Real</i>	-2147483.648 ... 2147483.647	-	1 = 1
90.66	Pos counter init value source	<i>Binary src</i>	-	-	1 = 1
90.67	Pos counter init cmd source	<i>Binary src</i>	-	-	1 = 1
90.68	Disable pos counter initialization	<i>Binary src</i>	-	-	1 = 1
90.69	Reset pos counter init ready	<i>Binary src</i>	-	-	1 = 1
91 Encoder module settings					
91.01	FEN DI status	<i>PB</i>	000000b...111111b	-	1 = 1
91.02	Module 1 status	<i>List</i>	-	-	1 = 1
91.03	Module 2 status	<i>List</i>	-	-	1 = 1
91.04	Module 1 temperature	<i>Real</i>	0...1000	°C, °F or ohm	1 = 1 unit
91.06	Module 2 temperature	<i>Real</i>	0...1000	°C, °F or ohm	1 = 1 unit
91.10	Encoder parameter refresh	<i>List</i>	0...1	-	1 = 1
91.11	Module 1 type	<i>List</i>	0...4	-	1 = 1
91.12	Module 1 location	<i>Real</i>	1...254	-	1 = 1
91.13	Module 2 type	<i>List</i>	0...4	-	1 = 1
91.14	Module 2 location	<i>Real</i>	1...254	-	1 = 1
91.21	Module 1 temp sensor type	<i>List</i>	0...2	-	1 = 1
91.22	Module 1 temp filter time	<i>Real</i>	0...10000	ms	1 = 1 ms
91.24	Module 2 temp sensor type	<i>List</i>	0...2	-	1 = 1
91.25	Module 2 temp filter time	<i>Real</i>	0...10000	ms	1 = 1 ms
91.31	Module 1 TTL output source	<i>List</i>	0...2	-	1 = 1
91.32	Module 1 emulation pulses/rev	<i>Real</i>	0...65535	-	1 = 1
91.33	Module 1 emulated Z-pulse offset	<i>Real</i>	0.00000 ... 1.00000	rev	100000 = 1 rev
91.41	Module 2 TTL output source	<i>List</i>	0...2	-	1 = 1
91.42	Module 2 emulation pulses/rev	<i>Real</i>	0...65535	-	1 = 1
91.43	Module 2 emulated Z-pulse offset	<i>Real</i>	0.00000 ... 1.00000	rev	100000 = 1 rev
92 Encoder 1 configuration					
92.01	Encoder 1 type	<i>List</i>	0...9	-	1 = 1

474 Additional parameter data

No.	Name	Type	Range	Unit	FbEq32
92.02	Encoder 1 source	List	1...2	-	1 = 1
<i>Other parameters in this group when a TTL, TTL+ and HTL encoder is selected (92.16, 92.17, 92.23...92.25 visible depending on encoder type selection)</i>					
92.10	Pulses/revolution	Real	0...65535	-	1 = 1
92.11	Pulse encoder type	List	0...1	-	1 = 1
92.12	Speed calculation mode	List	0...5	-	1 = 1
92.13	Position estimation enable	List	0...1	-	1 = 1
92.14	Speed estimation enable	List	0...1	-	1 = 1
92.15	Transient filter	List	0...3	-	1 = 1
92.16	Encoder 1 supply voltage	List	0...2	-	1 = 1
92.17	Accepted pulse freq of encoder 1	Real	0...300	kHz	1 = 1 kHz
92.21	Encoder cable fault mode	List	0...3	-	1 = 1
92.23	Maximum pulse waiting time	Real	1...200	ms	1 = 1 ms
92.24	Pulse edge filtering	List	0...2	-	1 = 1
92.25	Pulse overfrequency function	List	0...1	-	1 = 1
<i>Other parameters in this group when an absolute encoder is selected</i>					
92.10	Sine/cosine number	Real	0...65535	-	1 = 1
92.11	Absolute position source	List	0...5	-	1 = 1
92.12	Zero pulse enable	List	0...1	-	1 = 1
92.13	Position data width	Real	0...32	-	1 = 1
92.14	Revolution data width	Real	0...32	-	1 = 1
92.30	Serial link mode	List	0...2	-	1 = 1
92.31	EnDat max calculation time	List	0...3	-	1 = 1
92.32	SSI cycle time	List	0...5	-	1 = 1
92.33	SSI clock cycles	Real	2...127	-	1 = 1
92.34	SSI position msb	Real	1...126	-	1 = 1
92.35	SSI revolution msb	Real	1...126	-	1 = 1
92.36	SSI data format	List	0...1	-	1 = 1
92.37	SSI baud rate	List	0...5	-	1 = 1
92.40	SSI zero phase	List	0...3	-	1 = 1
92.45	Hiperface parity	List	0...1	-	1 = 1
92.46	Hiperface baud rate	List	0...3	-	1 = 1
92.47	Hiperface node address	Real	0...255	-	1 = 1
<i>Other parameters in this group when a resolver is selected</i>					
92.10	Excitation signal frequency	Real	1...20	kHz	1 = 1 kHz
92.11	Excitation signal amplitude	Real	4.0 ... 12.0	V	10 = 1 V
92.12	Resolver polepairs	List	1...32	-	1 = 1
93 Encoder 2 configuration					
93.01	Encoder 2 type	List	0...9	-	1 = 1
93.02	Encoder 2 source	List	1...2	-	1 = 1

No.	Name	Type	Range	Unit	FbEq32
<i>Other parameters in this group when a TTL, TTL+ and HTL encoder is selected (93.16, 93.17, 93.23...93.25 visible depending on encoder type selection)</i>					
93.10	Pulses/rev	<i>Real</i>	0...65535	-	1 = 1
93.11	Pulse encoder type	<i>List</i>	0...1	-	1 = 1
93.12	Speed calculation mode	<i>List</i>	0...5	-	1 = 1
93.13	Position estimation enable	<i>List</i>	0...1	-	1 = 1
93.14	Speed estimation enable	<i>List</i>	0...1	-	1 = 1
93.15	Transient filter	<i>List</i>	0...3	-	1 = 1
93.16	Encoder 2 supply voltage	<i>List</i>	0...2	-	1 = 1
93.17	Accepted pulse freq of encoder 2	<i>Real</i>	0...300	kHz	1 = 1 kHz
93.21	Encoder cable fault mode	<i>List</i>	0...3	-	1 = 1
93.23	Maximum pulse waiting time	<i>Real</i>	1...200	ms	1 = 1 ms
93.24	Pulse edge filtering	<i>List</i>	0...2	-	1 = 1
93.25	Pulse overfrequency function	<i>List</i>	0...1	-	1 = 1
<i>Other parameters in this group when an absolute encoder is selected</i>					
93.10	Sine/cosine number	<i>Real</i>	0...65535	-	1 = 1
93.11	Absolute position source	<i>List</i>	0...5	-	1 = 1
93.12	Zero pulse enable	<i>List</i>	0...1	-	1 = 1
93.13	Position data width	<i>Real</i>	0...32	-	1 = 1
93.14	Revolution data width	<i>Real</i>	0...32	-	1 = 1
93.30	Serial link mode	<i>List</i>	0...2	-	1 = 1
93.31	EnDat calc time	<i>List</i>	0...3	-	1 = 1
93.32	SSI cycle time	<i>List</i>	0...5	-	1 = 1
93.33	SSI clock cycles	<i>Real</i>	2...127	-	1 = 1
93.34	SSI position msb	<i>Real</i>	1...126	-	1 = 1
93.35	SSI revolution msb	<i>Real</i>	1...126	-	1 = 1
93.36	SSI data format	<i>List</i>	0...1	-	1 = 1
93.37	SSI baud rate	<i>List</i>	0...5	-	1 = 1
93.40	SSI zero phase	<i>List</i>	0...3	-	1 = 1
93.45	Hiperface parity	<i>List</i>	0...1	-	1 = 1
93.46	Hiperface baud rate	<i>List</i>	0...3	-	1 = 1
93.47	Hiperface node address	<i>Real</i>	0...255	-	1 = 1
<i>Other parameters in this group when a resolver is selected</i>					
93.10	Excitation signal frequency	<i>Real</i>	1...20	kHz	1 = 1 kHz
93.11	Excitation signal amplitude	<i>Real</i>	4.0 ... 12.0	V	10 = 1 V
93.12	Resolver polepairs	<i>List</i>	1...32	-	1 = 1
95 HW configuration					
95.01	Supply voltage	<i>List</i>	0...6	-	1 = 1
95.02	Adaptive voltage limits	<i>List</i>	0...1	-	1 = 1
95.04	Control board supply	<i>List</i>	0...2	-	1 = 1
95.08	DC switch monitoring	<i>List</i>	0...1	-	1 = 1

476 Additional parameter data

No.	Name	Type	Range	Unit	FbEq32
95.15	Special HW settings	<i>PB</i>	0000h...FFFFh	-	1 = 1
95.20	HW options word 1	<i>PB</i>	0000h...FFFFh	-	1 = 1
95.21	HW options word 2	<i>PB</i>	0000h...FFFFh	-	1 = 1
96 System					
96.01	Language	<i>List</i>	-	-	1 = 1
96.02	Pass code	<i>Data</i>	0...99999999	-	1 = 1
96.03	Access levels active	<i>PB</i>	0000h...FFFFh	-	1 = 1
96.04	Macro select	<i>List</i>	0...6	-	1 = 1
96.05	Macro active	<i>List</i>	1...6	-	1 = 1
96.06	Parameter restore	<i>List</i>	-	-	1 = 1
96.07	Parameter save manually	<i>List</i>	0...1	-	1 = 1
96.08	Control board boot	<i>Real</i>	0...1	-	1 = 1
96.09	FSO reboot	<i>Binary src</i>	-	-	-
96.10	User set status	<i>List</i>	-	-	-
96.11	User set save/load	<i>List</i>	-	-	-
96.12	User set I/O mode in1	<i>Binary src</i>	-	-	-
96.13	User set I/O mode in2	<i>Binary src</i>	-	-	-
96.16	Unit selection	<i>PB</i>	0000h...FFFFh	-	1 = 1
96.20	Time sync primary source	<i>List</i>	0...9	-	1 = 1
96.23	M/F and D2D clock synchronization	<i>List</i>	0...1	-	1 = 1
96.24	Full days since 1st Jan 1980	<i>Real</i>	1...59999	-	1 = 1
96.25	Time in minutes within 24 h	<i>Real</i>	0...1439	-	1 = 1
96.26	Time in ms within one minute	<i>Real</i>	0...59999	-	1 = 1
96.29	Time sync source status	<i>PB</i>	0000h...FFFFh	-	1 = 1
96.31	Drive ID number	<i>Real</i>	0...32767	-	1 = 1
96.61	User data logger status word	<i>PB</i>	0000h...FFFFh	-	1 = 1
96.63	User data logger trigger	<i>Binary src</i>	-	-	-
96.64	User data logger start	<i>Binary src</i>	-	-	-
96.65	Factory data logger time level	<i>List</i>	-	-	1 = 1
97 Motor control					
97.03	Slip gain	<i>Real</i>	0...200	%	1 = 1%
97.04	Voltage reserve	<i>Real</i>	-4...50	%	1 = 1%
97.05	Flux braking	<i>List</i>	0...2	-	1 = 1
97.06	Flux reference select	<i>Binary src</i>	-	-	1 = 1
97.07	User flux reference	<i>Real</i>	0.00 ... 200.00	%	100 = 1%
97.09	Switching freq mode	<i>List</i>	0...3	-	1 = 1

No.	Name	Type	Range	Unit	FbEq32
97.10	Signal injection	<i>List</i>	0...4	-	1 = 1
97.11	TR tuning	<i>Real</i>	25...400	%	1 = 1%
97.12	IR comp step-up frequency	<i>Real</i>	0.0 ... 50.0	Hz	10 = 1 Hz
97.13	IR compensation	<i>Real</i>	0.00 ... 50.00	%	100 = 1%
97.15	Motor model temperature adaptation	<i>List</i>	0...3	-	1 = 1
97.32	Motor torque unfiltered	<i>Real</i>	-1600.0 ... 1600.0	%	10 = 1%
97.33	Speed estimate filter time	<i>Real</i>	0.00 ... 100.00	ms	100 = 1 ms
98 User motor parameters					
98.01	User motor model mode	<i>List</i>	0...3	-	1 = 1
98.02	Rs user	<i>Real</i>	0.0000 ... 0.50000	p.u.	100000 = 1 p.u.
98.03	Rr user	<i>Real</i>	0.0000 ... 0.50000	p.u.	100000 = 1 p.u.
98.04	Lm user	<i>Real</i>	0.00000 ... 10.00000	p.u.	100000 = 1 p.u.
98.05	SigmaL user	<i>Real</i>	0.00000 ... 1.00000	p.u.	100000 = 1 p.u.
98.06	Ld user	<i>Real</i>	0.00000 ... 10.00000	p.u.	100000 = 1 p.u.
98.07	Lq user	<i>Real</i>	0.00000 ... 10.00000	p.u.	100000 = 1 p.u.
98.08	PM flux user	<i>Real</i>	0.00000 ... 2.00000	p.u.	100000 = 1 p.u.
98.09	Rs user SI	<i>Real</i>	0.00000 ... 100.00000	ohm	100000 = 1 p.u.
98.10	Rr user SI	<i>Real</i>	0.00000 ... 100.00000	ohm	100000 = 1 p.u.
98.11	Lm user SI	<i>Real</i>	0.00 ... 100000.00	mH	100 = 1 mH
98.12	SigmaL user SI	<i>Real</i>	0.00 ... 100000.00	mH	100 = 1 mH
98.13	Ld user SI	<i>Real</i>	0.00 ... 100000.00	mH	100 = 1 mH
98.14	Lq user SI	<i>Real</i>	0.00 ... 100000.00	mH	100 = 1 mH
98.15	Position offset user	<i>Real</i>	0...360	degrees electrical	1 = 1 deg
99 Motor data					
99.03	Motor type	<i>List</i>	0...1 or 0...2	-	1 = 1
99.04	Motor control mode	<i>List</i>	0...1	-	1 = 1
99.06	Motor nominal current	<i>Real</i>	0.0 ... 32767.0	A	10 = 1 A
99.07	Motor nominal voltage	<i>Real</i>	0.0 ... 32767.0	V	10 = 1 V
99.08	Motor nominal frequency	<i>Real</i>	0.00 ... 500.00	Hz	10 = 1 Hz
99.09	Motor nominal speed	<i>Real</i>	0 ... 30000	rpm	1 = 1 rpm
99.10	Motor nominal power	<i>Real</i>	0.00 ... 10000.00 kW or 0.00 ... 13404.83 hp	kW or hp	100 = 1 unit
99.11	Motor nominal cos Φ	<i>Real</i>	0.00 ... 1.00	-	100 = 1

478 *Additional parameter data*

No.	Name	Type	Range	Unit	FbEq32
99.12	Motor nominal torque	<i>Real</i>	0.000 ...	N·m or lb·ft	1000 = 1 unit
99.13	ID run requested	<i>List</i>	0...7	-	1 = 1
99.14	Last ID run performed	<i>List</i>	0...7	-	1 = 1
99.15	Motor polepairs calculated	<i>Real</i>	0...1000	-	1 = 1
99.16	Motor phase order	<i>List</i>	0...1	-	1 = 1
200 Safety					
This group contains parameters related to the optional FSO-xx safety functions module. For details on the parameters in this group, refer to the documentation of the FSO-xx module.					

9

Fault tracing

What this chapter contains

The chapter lists the warning and fault messages including possible causes and corrective actions. The causes of most warnings and faults can be identified and corrected using the information in this chapter. If not, an ABB service representative should be contacted.

Warnings and faults are listed below in separate tables. Each table is sorted by warning/fault code.

Safety



WARNING! Only qualified electricians are allowed to service the drive. Read the *Safety instructions* on the first pages of the Hardware manual before working on the drive.

Indications

■ Warnings and faults

Warnings and faults indicate an abnormal drive status. The codes and names of active warnings/faults are displayed on the control panel of the drive as well as the Drive composer PC tool. Only the codes of warnings/faults are available over fieldbus.

Warnings do not need to be reset; they stop showing when the cause of the warning ceases. Warnings do not latch and the drive will continue to operate the motor.

Faults do latch inside the drive and cause the drive to trip, and the motor stops. After the cause of a fault has been removed, the fault can be reset from a selectable

source (see parameter [31.11 Fault reset selection](#)) such as the control panel, Drive composer PC tool, the digital inputs of the drive, or fieldbus. After the fault is reset, the drive can be restarted. Note that some faults require a reboot of the control unit either by switching the power off and on, or using parameter [96.08 Control board boot](#) – this is mentioned in the fault listing wherever appropriate.

Warning and fault indications can be directed to a relay output or a digital input/output by selecting [Warning](#), [Fault](#) or [Fault \(-1\)](#) in the source selection parameter. See sections

- [Programmable digital inputs and outputs](#) (page 36)
- [Programmable relay outputs](#) (page 37), and
- [Programmable I/O extensions](#) (page 37).

■ Pure events

In addition to warnings and faults, there are pure events that are only recorded in the event logs of the drive. The codes of these events are included in the [Warning messages](#) table.

■ Editable messages

For some warnings and faults, the message text can be edited and instructions and contact information added. To edit these messages, choose **Menu - Settings - Edit texts** on the control panel.

Warning/fault history and analysis

■ Event logs

The drive has two event logs that can be accessed from the main Menu on the control panel. The logs can also be accessed (and reset) using the Drive composer PC tool.

One of the logs contains faults and fault resets. The other log lists warnings and pure events, as well as clearing entries. Both logs contain 32 most recent events. All indications are stored in the event logs with a time stamp and other information.

Auxiliary codes

Some events generate an auxiliary code that often helps in pinpointing the problem. The auxiliary code is displayed on the control panel together with the message. It is also stored in the event log details. In the Drive composer PC tool, the auxiliary code (if any) is shown in the event listing.

Factory data logger

The drive has a data logger that samples preselected drive values at 500-microsecond (default; see parameter [96.65 Factory data logger time level](#)) intervals. Approximately 7000 samples recorded immediately before and after a fault are saved

to the memory unit of the drive. The fault data of the last five faults is accessible in the event log when viewed in the Drive composer pro PC tool. (The fault data is not accessible through the control panel.)

The values that are recorded in the factory data log are [01.07 Motor current](#), [01.10 Motor torque](#), [01.11 DC voltage](#), [01.24 Flux actual %](#), [06.01 Main control word](#), [06.11 Main status word](#), [24.01 Used speed reference](#), [30.01 Limit word 1](#), [30.02 Torque limit status](#) and [90.01 Motor speed for control](#). The selection of parameters cannot be changed by the user.

■ Other data loggers

User data logger

A custom data logger can be configured using the Drive composer pro PC tool. This functionality enables the free selection of up to eight drive parameters to be sampled at selectable intervals. The triggering conditions and the length of the monitoring period can also be defined by the user within the limit of approximately 8000 samples. In addition to the PC tool, the status of the logger is shown by drive parameter [96.61 User data logger status word](#). The triggering sources can be selected by parameters [96.63 User data logger trigger](#) and [96.64 User data logger start](#)). The configuration, status and collected data is saved to the memory unit for later analysis.

■ Parameters that contain warning/fault information

The drive is able to store a list of the active faults actually causing the drive to trip at the present time. The faults are displayed in parameter group [04 Warnings and faults](#) (page [99](#)). The parameter group also displays a list of faults and warnings that have previously occurred.

Event word (parameters [04.40...04.72](#))

Parameter [04.40 Event word 1](#) can be configured by the user to indicate the status of 16 selectable events (ie. faults, warnings or pure events). It is possible to specify an auxiliary code for each event to filter out other auxiliary codes.

QR Code generation for mobile service application

A QR Code (or a series of QR Codes) can be generated by the drive for display on the control panel. The QR Code contains drive identification data, information on the latest events, and values of status and counter parameters. The code can be read with a mobile device containing the ABB service application, which then sends the data to ABB for analysis. For more information on the application, contact your local ABB service representative.

The QR Code can be generated by choosing **Menu - Assistants - QR code** on the control panel.

Warning messages

Note: The list also contains events that only appear in the Event log.

Code (hex)	Warning	Cause	What to do
A2A1	Current calibration	Current offset and gain measurement calibration will occur at next start.	Informative warning. (See parameter 99.13 ID run requested .)
A2B1	Overcurrent	Output current has exceeded internal fault limit.	<p>Check motor load.</p> <p>Check acceleration times in parameter group 23 Speed reference ramp (speed control), 26 Torque reference chain (torque control) or 28 Frequency reference chain (frequency control). Also check parameters 46.01 Speed scaling, 46.02 Frequency scaling and 46.03 Torque scaling.</p> <p>Check motor and motor cable (including phasing and delta/star connection).</p> <p>Check there are no contactors opening and closing in motor cable.</p> <p>Check that the start-up data in parameter group 99 corresponds to the motor rating plate.</p> <p>Check that there are no power factor correction capacitors or surge absorbers in motor cable.</p> <p>Check encoder cable (including phasing).</p>
A2B3	Earth leakage	Drive has detected load unbalance typically due to earth fault in motor or motor cable.	<p>Check there are no power factor correction capacitors or surge absorbers in motor cable.</p> <p>Check for an earth fault in motor or motor cables by measuring the insulation resistances of motor and motor cable.</p> <p>Try running the motor in scalar control mode if allowed. (See parameter 99.04 Motor control mode.)</p> <p>If no earth fault can be detected, contact your local ABB representative.</p>

Code (hex)	Warning	Cause	What to do
A2B4	Short circuit	Short-circuit in motor cable(s) or motor.	Check motor and motor cable for cabling errors. Check there are no power factor correction capacitors or surge absorbers in motor cable.
A2BA	IGBT overload	Excessive IGBT junction to case temperature. This warning protects the IGBT(s) and can be activated by a short circuit in the motor cable.	Check motor cable. Check ambient conditions. Check air flow and fan operation. Check heatsink fins for dust pick-up. Check motor power against drive power.
A3A1	DC link overvoltage	Intermediate circuit DC voltage too high (when the drive is stopped).	Check the supply voltage setting (parameter 95.01 Supply voltage). Note that the wrong setting of the parameter may cause the motor to rush uncontrollably, or may overload the brake chopper or resistor. Check the supply voltage. If the problem persists, contact your local ABB representative.
A3A2	DC link undervoltage	Intermediate circuit DC voltage too low (when the drive is stopped).	
A3AA	DC not charged	The voltage of the intermediate DC circuit has not yet risen to operating level.	
A480	Motor cable overload	Calculated motor cable temperature has exceeded warning limit.	Check the settings of parameters 35.61 and 35.62 . Check the dimensioning of the motor cable in regard to required load.
A490	Incorrect temperature sensor setup	Sensor type mismatch	Check the settings of temperature source parameters 35.11 and 35.21 against 91.21 and 91.24 .
		Faulty wiring between an encoder interface module and the temperature sensor.	Check the wiring of the sensor. The auxiliary code identifies the interface module. (0 = Module 1, 1 = Module 2).
A491	External temperature 1 (Editable message text)	Measured temperature 1 has exceeded warning limit.	Check the value of parameter 35.02 Measured temperature 1 . Check the cooling of the motor (or other equipment whose temperature is being measured). Check the value of 35.13 Temperature 1 warning limit .

Code (hex)	Warning	Cause	What to do
A492	External temperature 2 (Editable message text)	Measured temperature 2 has exceeded warning limit.	Check the value of parameter 35.03 Measured temperature 2 . Check the cooling of the motor (or other equipment whose temperature is being measured). Check the value of 35.23 Temperature 2 warning limit .
A4A0	Control board temperature	Control unit temperature is excessive.	Check the auxiliary code. See actions for each code below.
	(none)	Temperature above warning limit	Check ambient conditions. Check air flow and fan operation. Check heatsink fins for dust pick-up.
	1	Thermistor broken	Contact an ABB service representative for control unit replacement.
A4A1	IGBT overtemperature	Estimated drive IGBT temperature is excessive.	Check ambient conditions. Check air flow and fan operation. Check heatsink fins for dust pick-up. Check motor power against drive power.
A4A9	Cooling	Drive module temperature is excessive.	Check ambient temperature. If it exceeds 40 °C (104 °F), ensure that load current does not exceed derated load capacity of drive. See appropriate <i>Hardware manual</i> . Check drive module cooling air flow and fan operation. Check inside of cabinet and heatsink of drive module for dust pick-up. Clean whenever necessary.
A4B0	Excess temperature	Power unit module temperature is excessive.	Check ambient conditions. Check air flow and fan operation. Check heatsink fins for dust pick-up. Check motor power against drive power.

Code (hex)	Warning	Cause	What to do
A4B1	Excess temperature difference	High temperature difference between the IGBTs of different phases.	<p>Check the motor cabling.</p> <p>Check cooling of drive module(s).</p> <p>Check the auxiliary code (format XXXY YYZZ). “XXX” indicates the source of difference (0: Single module, difference between phase IGBTs, 1: parallel-connected modules, minimum-maximum difference between all IGBTs of all modules). With parallel-connected modules, “Y YY” specifies through which BCU control unit channel the fault was received. “ZZ” specifies the phase (0: single module, 1: U-phase [parallel connection], 2: W-phase [parallel connection], 3: W-phase [parallel connection]).</p>
A4B2	PCB space cooling	Temperature difference between ambient and drive module PCB space is excessive.	<p>Check the cooling fan inside the PCB space.</p> <p>With parallel-connected modules, check the auxiliary code (format XXXY YYZZ). “Y YY” specifies through which BCU control unit channel the fault was received.</p>
A4F6	IGBT temperature	Drive IGBT temperature is excessive.	<p>Check ambient conditions.</p> <p>Check air flow and fan operation.</p> <p>Check heatsink fins for dust pick-up.</p> <p>Check motor power against drive power.</p>

Code (hex)	Warning	Cause	What to do
A580	PU communication	Communication errors detected between the drive control unit and the power unit.	<p>Check the connections between the drive control unit and the power unit.</p> <p>Check the auxiliary code (format XXXY YYZZ). With parallel-connected modules, “Y YY” specifies the affected BCU control unit channel (0: broadcast). “ZZ” specifies the error source (8: Transmission errors in PSL link [see “XXX”], 9: Transmitter FIFO warning limit hit). “XXX” specifies the transmission error direction and detailed warning code (0: Rx/communication error, 1: Tx/Reed-Solomon symbol error, 2: Tx/no synchronization error, 3: Tx/Reed-Solomon decoder failures, 4: Tx/Manchester coding errors).</p>
A581	Fan	Cooling fan feedback missing.	<p>Check the setting of parameter 95.20 HW options word 1, bit 14.</p> <p>Check the auxiliary code to identify the fan. Code 0 denotes main fan 1. Other codes (format XYZ): “X” specifies state code (1: ID run, 2: normal). “Y” specifies the index of the inverter unit connected to BCU (0...n, always 0 for ZCU control units). “Z” specifies the index of the fan (1: Main fan 1, 2: Main fan 2, 3: Main fan 3).</p> <p>Check fan operation and connection.</p> <p>Replace fan if faulty.</p>

Code (hex)	Warning	Cause	What to do
A582	Auxiliary fan missing	An auxiliary cooling fan (connected to the fan connectors on the control unit) is stuck or disconnected.	The auxiliary code identifies the fan (1 : Auxiliary fan 1, 2 : Auxiliary fan 2). Check auxiliary fan(s) and connection(s). Replace faulty fan. Make sure the front cover of the drive module is in place and tightened. If the commissioning of the drive requires that the cover is off, this warning will be generated even if the corresponding fault is defeated. See fault <i>5081 Auxiliary fan broken</i> (page 509).
A5A0	Safe torque off Programmable warning: <i>31.22 STO indication run/stop</i>	Safe torque off function is active, i.e. safety circuit signal(s) connected to connector XSTO is lost.	Check safety circuit connections. For more information, see appropriate drive hardware manual and description of parameter <i>31.22 STO indication run/stop</i> (page 268).
A5EA	Measurement circuit temperature	Problem with internal temperature measurement of the drive.	Check the auxiliary code (format XXXY YYZZ). “Y YY” specifies through which BCU control unit channel the fault was received (“0 00” with a ZCU control unit). “ZZ” specifies the location (1 : U-phase IGBT, 2 : V-phase IGBT, 3 : W-phase IGBT, 4 : Power unit INT board, 5 : Brake chopper, 6 : Air inlet, 7 : Power supply board, 8 : du/dt filter, FAh : Air in temp).
A5EB	PU board powerfail	Power unit power supply failure.	Contact your local ABB representative.
A5EC	PU communication internal	Communication errors detected between the drive control unit and the power unit.	Check the connections between the drive control unit and the power unit.
A5ED	Measurement circuit ADC	Problem with measurement circuit of power unit (analog to digital converter)	Contact your local ABB representative.
A5EE	Measurement circuit DFF	Problem with current or voltage measurement of power unit	Contact your local ABB representative.

Code (hex)	Warning	Cause	What to do
A5EF	PU state feedback	State feedback from output phases does not match control signals.	Contact your local ABB representative.
A5F0	Charging feedback	Charging in progress	Informative warning. Wait until charging finishes before starting the inverter unit.
A5F3	Switching frequency below requested	Adequate motor control at requested output frequency cannot be reached because of limited switching frequency (eg. by parameter 95.15).	Informative warning.
A683	Data saving to power unit	An error in saving data to the power unit.	Check the auxiliary code. See actions for each code below.
		0 An error is preventing saving from initializing.	Cycle the power to the drive. If the control unit is externally powered, also reboot the control unit (using parameter 96.08 Control board boot) or by cycling its power. If the problem persists, contact your local ABB representative.
		1	
		2 Write error.	
A685	Power fail saving	Power fail saving is requested too frequently due to oscillating power supply to the control unit. Some of the requests may have been discarded, potentially causing data loss.	Check the power supply of the control unit. If powered internally from the drive, check the supply voltage of the drive.
A6A4	Motor nominal value	The motor parameters are set incorrectly.	Check the auxiliary code. See actions for each code below.
		The drive is not dimensioned correctly.	

Code (hex)	Warning	Cause	What to do
		1 Slip frequency is too small	Check the settings of the motor configuration parameters in groups 98 and 99. Check that the drive is sized correctly for the motor.
		2 Synchronous and nominal speeds differ too much	
		3 Nominal speed is higher than synchronous speed with 1 pole pair	
		4 Nominal current is outside limits	
		5 Nominal voltage is outside limits	
		6 Nominal power is higher than apparent power	
		7 Nominal power not consistent with nominal speed and torque	
A6A5	No motor data	Parameters in group 99 have not been set.	Check that all the required parameters in group 99 have been set. Note: It is normal for this warning to appear during the start-up and continue until the motor data is entered.
A6A6	Supply voltage unselected	The supply voltage has not been defined.	Set supply voltage in parameter 95.01 Supply voltage .
A6D1	FBA A parameter conflict	The drive does not have a functionality requested by a PLC, or requested functionality has not been activated.	Check PLC programming. Check settings of parameter groups 50 Fieldbus adapter (FBA) and 51 FBA A settings .
A6D2	FBA B parameter conflict	The drive does not have a functionality requested by a PLC, or requested functionality has not been activated.	Check PLC programming. Check settings of parameter groups 50 Fieldbus adapter (FBA) and 54 FBA B settings .

Code (hex)	Warning	Cause	What to do
A6DA	Reference source parametrization	A reference source is simultaneously connected to multiple parameters with different units.	<p>Check the reference source selection parameters.</p> <p>Check the auxiliary code (format XXYY 00ZZ). “XX” and “YY” specify the two sets of parameters where the source was connected to (01 = speed reference chain [22.11, 22.12, 22.15, 22.17], 02 = frequency reference chain [28.11, 28.12], 03 = torque reference chain [26.11, 26.12, 26.16], 04 = other torque-related parameters [26.25, 30.21, 30.22]. “ZZ” indicates the conflicting reference source (01...0E = index in parameter group 3, 3D = motor potentiometer, 65 = AI1, 66 = AI2, 6F = frequency input).</p>
A6E5	AI parametrization	The current/voltage hardware setting of an analog input does not correspond to parameter settings.	<p>Check the auxiliary code. The code identifies the analog input whose settings are in conflict.</p> <p>Adjust either the hardware setting (on the drive control unit) or parameter 12.15/12.25.</p> <p>Note: Control board reboot (either by cycling the power or through parameter 96.08 <i>Control board boot</i>) is required to validate any changes in the hardware settings.</p>
A780	Motor stall Programmable warning: 31.24 <i>Stall function</i>	Motor is operating in stall region because of e.g. excessive load or insufficient motor power.	<p>Check motor load and drive ratings.</p> <p>Check fault function parameters.</p>
A781	Motor fan Programmable warning: 35.106 <i>DOL starter event type</i>	No feedback received from external fan.	<p>Check external fan (or other equipment controlled) by the logic.</p> <p>Check settings of parameters 35.100...35.106.</p>

Code (hex)	Warning	Cause	What to do
A782	FEN temperature	Error in temperature measurement when temperature sensor (KTY or PTC) connected to encoder interface FEN-xx is used.	Check that parameter 35.11 Temperature 1 source / 35.21 Temperature 2 source setting corresponds to actual encoder interface installation.
		Error in temperature measurement when KTY sensor connected to encoder interface FEN-01 is used.	FEN-01 does not support temperature measurement with KTY sensor. Use PTC sensor or other encoder interface module.
A791	Brake resistor	Brake resistor broken or not connected.	Check that a brake resistor has been connected. Check the condition of the brake resistor.
A797	Speed feedback configuration	Speed feedback configuration has changed.	Check the auxiliary code (format XXYY ZZZZ). "XX" specifies the number of the encoder interface module (01 : 91.11/91.12 , 02 : 91.13/91.14), "YY" specifies the encoder (01 : 92 Encoder 1 configuration , 02 : 93 Encoder 2 configuration). "ZZZZ" indicates the problem (see actions for each code below).
		0001 Adapter not found in specified slot.	Check module location (91.12 or 91.14).
		0002 Detected type of interface module does not match parameter setting.	Check the module type (91.11 or 91.13) against status (91.02 or 91.03).
		0003 Logic version too old.	Contact your local ABB representative.
		0004 Software version too old.	Contact your local ABB representative.
		0006 Encoder type incompatible with interface module type.	Check module type (91.11 or 91.13) against encoder type (92.01 or 93.01).
		0007 Adapter not configured.	Check module location (91.12 or 91.14).
		0008 Speed feedback configuration has changed.	Use parameter 91.10 Encoder parameter refresh to validate any changes in the settings.

Code (hex)	Warning	Cause	What to do
	0009	No encoders configured to encoder module	Configure the encoder in group 92 Encoder 1 configuration or 93 Encoder 2 configuration .
	000A	Non-existing emulation input.	Check input selection (91.31 or 91.41).
	000B	Echo not supported by selected input (for example, resolver or absolute encoder).	Check input selection (91.31 or 91.41), interface module type, and encoder type.
	000C	Emulation in continuous mode not supported.	Check input selection (91.31 or 91.41) and serial link mode (92.30 or 93.30) settings.
A79B	BC short circuit	Short circuit in brake chopper IGBT	Replace brake chopper if external. Drives with internal choppers will need to be returned to ABB. Ensure brake resistor is connected and not damaged.
A79C	BC IGBT excess temperature	Brake chopper IGBT temperature has exceeded internal warning limit.	Let chopper cool down. Check for excessive ambient temperature. Check for cooling fan failure. Check for obstructions in the air flow. Check the dimensioning and cooling of the cabinet. Check resistor overload protection function settings (parameters ...). Check minimum allowed resistor value for the chopper being used. Check that braking cycle meets allowed limits. Check that drive supply AC voltage is not excessive.
A7A1	Mechanical brake closing failed Programmable warning: 44.17 Brake fault function	Status of mechanical brake acknowledgement is not as expected during brake close.	Check mechanical brake connection. Check mechanical brake settings in parameter group 44 Mechanical brake control . Check that acknowledgement signal matches actual status of brake.

Code (hex)	Warning	Cause	What to do
A7A2	Mechanical brake opening failed Programmable warning: 44.17 Brake fault function	Status of mechanical brake acknowledgement is not as expected during brake open.	Check mechanical brake connection. Check mechanical brake settings in parameter group 44 Mechanical brake control . Check that acknowledgement signal matches actual status of brake.
A7A5	Mechanical brake opening not allowed Programmable warning: 44.17 Brake fault function	Open conditions of mechanical brake cannot be fulfilled (for example, brake has been prevented from opening by parameter 44.11 Keep brake closed).	Check mechanical brake settings in parameter group 44 Mechanical brake control (especially 44.11 Keep brake closed). Check that acknowledgement signal (if used) matches actual status of brake.
A7AA	Extension AI parameterization	The hardware current/voltage setting of an analog input (on an I/O extension module) does not correspond to parameter settings.	Check the auxiliary code (format XX00 00YY). “XX” specifies the number of the I/O extension module (01 : parameter group 14 I/O extension module 1 , 02 : 15 I/O extension module 2 , “YY” specifies the analog input on the module. For example, in case of I/O extension module 1, analog input AI1 (auxiliary code 0000 0101), the hardware current/voltage setting on the module is shown by parameter 14.29 . The corresponding parameter setting is 14.30 . Adjust either the hardware setting on the module or the parameter to solve the mismatch. Note: Control board reboot (either by cycling the power or through parameter 96.08 Control board boot) is required to validate any changes in the hardware settings.
A7AB	Extension I/O configuration failure	The I/O extension module types and locations specified by parameters do not match the detected configuration.	Check the auxiliary code. The code indicates which I/O extension module is affected. Check the type and location settings of the modules (parameters 14.01 , 14.02 , 15.01 and 15.02). Check that the modules are properly installed.

Code (hex)	Warning	Cause	What to do
A7B0	Motor speed feedback Programmable warning: 90.45 Motor feedback fault	No motor speed feedback is received.	Check the auxiliary code (format XXYY ZZZZ). “XX” specifies the number of the encoder interface module (01 : 91.11/91.12 , 02 : 91.13/91.14), “YY” specifies the encoder (01 : 92 Encoder 1 configuration , 02 : 93 Encoder 2 configuration). “ZZZZ” indicates the problem (see actions for each code below).
		0001 Motor gear definition invalid or outside limits.	Check motor gear settings (90.43 and 90.44).
		0002 Encoder not configured.	Check encoder settings (92 Encoder 1 configuration or 93 Encoder 2 configuration). Use parameter 91.10 Encoder parameter refresh to validate any changes in the settings.
		0003 Encoder stopped working.	Check encoder status.
		0004 Encoder drift detected.	Check for slippage between encoder and motor.
A7B1	Load speed feedback Programmable warning: 90.55 Load feedback fault	No load speed feedback is received.	Check the auxiliary code (format XXYY ZZZZ). “XX” specifies the number of the encoder interface module (01 : 91.11/91.12 , 02 : 91.13/91.14), “YY” specifies the encoder (01 : 92 Encoder 1 configuration , 02 : 93 Encoder 2 configuration). “ZZZZ” indicates the problem (see actions for each code below).
		0001 Load gear definition invalid or outside limits.	Check load gear settings (90.53 and 90.54).
		0002 Feed constant definition invalid or outside limits.	Check feed constant settings (90.63 and 90.64).
		0003 Encoder stopped working.	Check encoder status.

Code (hex)	Warning	Cause	What to do
A7C1	FBA A communication Programmable warning: 50.02 FBA A comm loss func	Cyclical communication between drive and fieldbus adapter module A or between PLC and fieldbus adapter module A is lost.	Check status of fieldbus communication. See user documentation of fieldbus interface. Check settings of parameter groups 50 Fieldbus adapter (FBA) , 51 FBA A settings , 52 FBA A data in and 53 FBA A data out . Check cable connections. Check if communication master is able to communicate.
A7C2	FBA B communication Programmable warning: 50.32 FBA B comm loss func	Cyclical communication between drive and fieldbus adapter module B or between PLC and fieldbus adapter module B is lost.	Check status of fieldbus communication. See user documentation of fieldbus interface. Check settings of parameter group 50 Fieldbus adapter (FBA) . Check cable connections. Check if communication master is able to communicate.
A7CB	MF comm loss Programmable warning: 60.09 M/F comm loss function	Master/follower communication is lost.	Check the auxiliary code. The code indicates which node address (defined by parameter 60.02 in each drive) on the master/follower link is affected. Check settings of parameter group 60 DDCS communication . Check cable connections. If necessary, replace cables.
A7CE	EFB comm loss Programmable warning: 58.14 Communication loss action	Communication break in embedded fieldbus (EFB) communication.	Check the status of the fieldbus master (online/offline/error etc.). Check cable connections to the XD2D connector on the control unit.
A7E1	Encoder Programmable warning: 90.45 Motor feedback fault	Encoder error.	Check the auxiliary code (format XXYY ZZZZ). “XX” specifies the number of the encoder interface module (01 : 91.11/91.12 , 02 : 91.13/91.14), “YY” specifies the encoder (01 : 92 Encoder 1 configuration , 02 : 93 Encoder 2 configuration). “ZZZZ” indicates the problem (see actions for each code below).

Code (hex)	Warning	Cause	What to do
	0001	Cable fault	Check the conductor order at both ends of the encoder cable. Check the groundings of the encoder cable. If the encoder was working previously, check the encoder, encoder cable and encoder interface module for damage. See also parameter 92.21 Encoder cable fault mode .
	0002	No encoder signal	Check the condition of the encoder.
	0003	Overspeed	Contact your local ABB representative.
	0004	Overfrequency	Contact your local ABB representative.
	0005	Resolver ID run failed	Contact your local ABB representative.
	0006	Resolver overcurrent fault	Contact your local ABB representative.
	0007	Speed scaling error	Contact your local ABB representative.
A7EE	Control panel loss Programmable warning: 49.05 Communication loss action	Control panel (or PC tool) has stopped communicating.	Check PC tool or control panel connection. Check control panel connector. Check mounting platform if being used. Disconnect and reconnect the control panel.
A780	Motor bearing Programmable warnings: 33.14 On-time 1 warn message 33.24 On-time 2 warn message 33.55 Value counter 1 warn message 33.65 Value counter 2 warn message	Warning generated by an on-time timer or a value counter.	Check the auxiliary code. Check the source of the warning corresponding to the code: 0: 33.13 On-time 1 source 1: 33.23 On-time 2 source 4: 33.53 Value counter 1 source 5: 33.63 Value counter 2 source .
A881	Output relay	Warning generated by an edge counter. Programmable warnings: 33.35 Edge counter 1 warn message 33.45 Edge counter 2 warn message	Check the auxiliary code. Check the source of the warning corresponding to the code: 2: 33.33 Edge counter 1 source 3: 33.43 Edge counter 2 source .
A882	Motor starts		
A883	Power ups		
A884	Main contactor		
A885	DC charge		

Code (hex)	Warning	Cause	What to do
A886	On-time 1 (Editable message text) Programmable warning: 33.14 On-time 1 warn message	Warning generated by on-time timer 1.	Check the source of the warning (parameter 33.13 On-time 1 source).
A887	On-time 2 (Editable message text) Programmable warning: 33.24 On-time 2 warn message	Warning generated by on-time timer 2.	Check the source of the warning (parameter 33.23 On-time 2 source).
A888	Edge counter 1 (Editable message text) Programmable warning: 33.35 Edge counter 1 warn message	Warning generated by edge counter 1.	Check the source of the warning (parameter 33.33 Edge counter 1 source).
A889	Edge counter 2 (Editable message text) Programmable warning: 33.45 Edge counter 2 warn message	Warning generated by edge counter 2.	Check the source of the warning (parameter 33.43 Edge counter 2 source).
A88A	Value counter 1 (Editable message text) Programmable warning: 33.55 Value counter 1 warn message	Warning generated by value counter 1.	Check the source of the warning (parameter 33.53 Value counter 1 source).
A88B	Value counter 2 (Editable message text) Programmable warning: 33.65 Value counter 2 warn message	Warning generated by value counter 2.	Check the source of the warning (parameter 33.63 Value counter 2 source).
A88C	Device clean	Warning generated by an on-time timer. Programmable warnings: 33.14 On-time 1 warn message 33.24 On-time 2 warn message	Check the auxiliary code. Check the source of the warning corresponding to the code: 0: 33.13 On-time 1 source 1: 33.23 On-time 2 source 10: 05.04 Fan on-time counter .
A88D	DC capacitor		
A88E	Cabinet fan		
A88F	Cooling fan		
A890	Additional cooling		
A8A0	AI supervision Programmable warning: 12.03 AI supervision function	An analog signal is outside the limits specified for the analog input.	Check the auxiliary code (format XYY). “X” specifies the location of the input (0 : AI on control unit; 1 : I/O extension module 1, etc.), “YY” specifies the input and limit (01 : AI1 under minimum, 02 : AI1 over maximum, 03 : AI2 under minimum, 04 : AI2 over maximum). Check signal level at the analog input. Check the wiring connected to the input. Check the minimum and maximum limits of the input in parameter group 12 Standard AI .

Code (hex)	Warning	Cause	What to do
A8B0	Signal supervision (Editable message text) Programmable warning: 32.06 Supervision 1 action	Warning generated by the signal supervision 1 function.	Check the source of the warning (parameter 32.07 Supervision 1 signal).
A8B1	Signal supervision 2 (Editable message text) Programmable warning: 32.16 Supervision 2 action	Warning generated by the signal supervision 2 function.	Check the source of the warning (parameter 32.17 Supervision 2 signal).
A8B2	Signal supervision 3 (Editable message text) Programmable warning: 32.26 Supervision 3 action	Warning generated by the signal supervision 3 function.	Check the source of the warning (parameter 32.27 Supervision 3 signal).
A8C0	Fan service counter	A cooling fan has reached the end of its estimated lifetime. See parameters 05.41 and 05.42 .	Check the auxiliary code. The code indicates which fan is to be replaced. 0: Main cooling fan 1: Auxiliary cooling fan 2: Auxiliary cooling fan 2 3: Cabinet cooling fan 4: PCB compartment fan Refer to the hardware manual of the drive for fan replacement instructions.
A981	External warning 1 (Editable message text) Programmable warning: 31.01 External event 1 source 31.02 External event 1 type	Fault in external device 1.	Check the external device. Check setting of parameter 31.01 External event 1 source .
A982	External warning 2 (Editable message text) Programmable warning: 31.03 External event 2 source 31.04 External event 2 type	Fault in external device 2.	Check the external device. Check setting of parameter 31.03 External event 2 source .
A983	External warning 3 (Editable message text) Programmable warning: 31.05 External event 3 source 31.06 External event 3 type	Fault in external device 3.	Check the external device. Check setting of parameter 31.05 External event 3 source .
A984	External warning 4 (Editable message text) Programmable warning: 31.07 External event 4 source 31.08 External event 4 type	Fault in external device 4.	Check the external device. Check setting of parameter 31.07 External event 4 source .
A985	External warning 5 (Editable message text) Programmable warning: 31.09 External event 5 source 31.10 External event 5 type	Fault in external device 5.	Check the external device. Check setting of parameter 31.09 External event 5 source .

500 Fault tracing

Code (hex)	Warning	Cause	What to do
AF85	Line side unit warning	The supply unit has generated a warning.	If using a control panel or the Drive composer tool, connect to the supply unit to read the warning code. Refer to the firmware manual of the supply unit for instructions related to the code.
AF90	Speed controller autotuning	The speed controller autotune routine did not complete successfully.	Check the auxiliary code (format XXXX YYYY). "YYYY" indicates the problem (see actions for each code below).
	0000	The drive was stopped before the autotune routine finished.	Repeat autotune until successful.
	0001	The drive was started but was not ready to follow the autotune command.	Make sure the prerequisites of the autotune run are fulfilled. See section Before activating the autotune routine (page 47).
	0002	Required torque reference could not be reached before the drive reached maximum speed.	Decrease torque step (parameter 25.38) or increase speed step (25.39).
	0003	Motor could not accelerate/decelerate to maximum/minimum speed.	Increase torque step (parameter 25.38) or decrease speed step (25.39).
	0005	Motor could not decelerate with full autotune torque.	Decrease torque step (parameter 25.38) or speed step (25.39).
AFAA	Autoreset	A fault is about to be autoreset.	Informative warning. See the settings in parameter group 31 Fault functions .

Code (hex)	Warning	Cause	What to do
AFE1	Emergency stop (off2)	Drive has received an emergency stop (mode selection off2) command.	Check that it is safe to continue operation. Reset the source of the emergency stop signal (such as an emergency stop push button). Restart drive. If the emergency stop was unintentional, check the source of the stop signal (for example, 21.05 Emergency stop source , or control word received from an external control system).
		(Follower drive in a master/follower configuration) Drive has received a stop command from the master.	Informative warning. After stopping on a ramp stop (Off1 or Off3) command, the master sends a short, 10-millisecond coast stop (Off2) command to the follower(s). The Off2 stop is stored in the event log of the follower.
AFE2	Emergency stop (off1 or off3)	Drive has received an emergency stop (mode selection Off1 or Off3) command.	Check that it is safe to continue operation. Reset the source of the emergency stop signal (such as an emergency stop push button). Restart drive. If the emergency stop was unintentional, check the source of the stop signal (for example, 21.05 Emergency stop source , or control word received from an external control system).
AFE7	Follower	A follower drive has tripped.	Check the auxiliary code. Add 2 to the code to find out the node address of the faulted drive. Correct the fault in the follower drive.
AFEA	Enable start signal missing (Editable message text)	No enable start signal received.	Check the setting of (and the source selected by) parameter 20.19 Enable start command .
AFEB	Run enable missing (Editable message text)	No run enable signal is received.	Check setting of parameter 20.12 Run enable 1 source . Switch signal on (e.g. in the fieldbus Control Word) or check wiring of selected source.

502 Fault tracing

Code (hex)	Warning	Cause	What to do
AFEC	External power signal missing	95.04 Control board supply is set to <i>External 24V</i> but no voltage is connected to the XPOW connector of the control unit.	Check the external 24 V DC power supply to the control unit, or change the setting of parameter 95.04 .
AFF6	Identification run	Motor ID run will occur at next start, or is in progress.	Informative warning.
AFF7	Autophasing	Autophasing will occur at next start.	Informative warning.
B5A0	STO event Programmable event: 31.22 STO indication run/stop	Safe torque off function is active, i.e. safety circuit signal(s) connected to connector XSTO is lost.	Check safety circuit connections. For more information, see appropriate drive hardware manual and description of parameter 31.22 STO indication run/stop (page 268).

Fault messages

Code (hex)	Fault	Cause	What to do
2281	Calibration	Measured offset of output phase current measurement or difference between output phase U2 and W2 current measurement is too great (the values are updated during current calibration).	Try performing the current calibration again (select <i>Current measurement calibration</i> at parameter <i>99.13</i>). If the fault persists, contact your local ABB representative.
2310	Overcurrent	Output current has exceeded internal fault limit.	<p>Check motor load.</p> <p>Check acceleration times in parameter group <i>23 Speed reference ramp</i> (speed control), <i>26 Torque reference chain</i> (torque control) or <i>28 Frequency reference chain</i> (frequency control). Also check parameters <i>31.42 Overcurrent fault limit</i>, <i>46.01 Speed scaling</i>, <i>46.02 Frequency scaling</i> and <i>46.03 Torque scaling</i>.</p> <p>Check motor and motor cable (including phasing and delta/star connection).</p> <p>Check there are no contactors opening and closing in motor cable.</p> <p>Check that the start-up data in parameter group 99 corresponds to the motor rating plate.</p> <p>Check that there are no power factor correction capacitors or surge absorbers in motor cable.</p> <p>Check encoder cable (including phasing).</p> <p>Check the auxiliary code (format XXXY YYZZ). With parallel-connected inverter modules, “Y YY” specifies through which BCU control unit channel the fault was received. “ZZ” indicates the phase that triggered the fault (0: No detailed information available, 1: U-phase, 2: V-phase, 4: W-phase, 3/5/6/7: multiple phases).</p>

Code (hex)	Fault	Cause	What to do
2330	Earth leakage Programmable fault: 31.20 Earth fault	Drive has detected load unbalance typically due to earth fault in motor or motor cable.	<p>Check there are no power factor correction capacitors or surge absorbers in motor cable.</p> <p>Check for an earth fault in motor or motor cables by measuring the insulation resistances of motor and motor cable.</p> <p>Try running the motor in scalar control mode if allowed. (See parameter 99.04 Motor control mode.)</p> <p>With parallel-connected modules, check the auxiliary code (format XXXY YYZZ). “Y YY” specifies through which BCU control unit channel the fault was received.</p> <p>If no earth fault can be detected, contact your local ABB representative.</p>
2340	Short circuit	Short-circuit in motor cable(s) or motor	<p>Check motor and motor cable for cabling errors.</p> <p>Check there are no power factor correction capacitors or surge absorbers in motor cable.</p> <p>Check the auxiliary code (format XXXY YYZZ). With parallel-connected inverter modules, “Y YY” specifies through which BCU control unit channel the fault was received. “ZZ” indicates the location of the short circuit (0: No detailed information available, 1: Upper branch of U-phase, 2: Lower branch of U-phase, 4: Upper branch of V-phase, 8: Lower branch of V-phase, 10: Upper branch of W-phase, 20: Lower branch of W-phase, other: combinations of the above).</p> <p>After correcting the cause of the fault, reboot the control unit (using parameter 96.08 Control board boot) or by cycling power.</p>

Code (hex)	Fault	Cause	What to do
2381	IGBT overload	Excessive IGBT junction to case temperature. This fault protects the IGBT(s) and can be activated by a short circuit in the motor cable.	Check motor cable. Check ambient conditions. Check air flow and fan operation. Check heatsink fins for dust pick-up. Check motor power against drive power.
2391	BU current difference	AC phase current difference between parallel-connected inverter modules is excessive.	Check motor cabling. Check there are no power factor correction capacitors or surge absorbers in motor cable. Check the auxiliary code (format XXXY YYZZ). "XXX" specifies the source of the first error (see "YYY"). "YYY" specifies the module through which BCU control unit channel the fault was received (1 : Channel 1, 2 : Channel 2, 4 : Channel 3, 8 : Channel 4, ..., 800 : Channel 12, other : combinations of the above). "ZZ" indicates the phase (1 : U, 2 : V, 3 : W).
2392	BU earth leakage	Total earth leakage of inverter modules is excessive.	Check there are no power factor correction capacitors or surge absorbers in motor cable. Measure insulation resistances of motor cables and motor. Contact your local ABB representative.
3130	Input phase loss Programmable fault: 31.21 Supply phase loss	Intermediate circuit DC voltage is oscillating due to missing input power line phase or blown fuse.	Check input power line fuses. Check for loose power cable connections. Check for input power supply imbalance.
3180	Charge relay lost	No acknowledgement received from charge relay.	Contact your local ABB representative.

Code (hex)	Fault	Cause	What to do
3181	Wiring or earth fault Programmable fault: 31.23 Wiring or earth fault	The drive hardware is supplied from a common DC bus.	Switch off the protection in parameter 31.23 .
		Incorrect input power and motor cable connection (i.e. input power cable is connected to the motor connection).	Check the power connections.
		Drive has detected load unbalance typically due to earth fault in motor or motor cable.	<p>Check there are no power factor correction capacitors or surge absorbers in motor cable.</p> <p>Check for an earth fault in motor or motor cables by measuring the insulation resistances of motor and motor cable.</p> <p>Try running the motor in scalar control mode if allowed. (See parameter 99.04 Motor control mode.)</p>
3210	DC link overvoltage	Excessive intermediate circuit DC voltage.	<p>Check that overvoltage control is on (parameter 30.30 Overvoltage control).</p> <p>Check that the supply voltage matches the nominal input voltage of the drive.</p> <p>Check the supply line for static or transient overvoltage.</p> <p>Check brake chopper and resistor (if present).</p> <p>Check deceleration time.</p> <p>Use coast-to-stop function (if applicable).</p> <p>Retrofit drive with brake chopper and brake resistor.</p> <p>With parallel-connected modules, check the auxiliary code (format XXXY YYZZ). “Y YY” specifies through which BCU control unit channel the fault was received.</p>

Code (hex)	Fault	Cause	What to do
3220	DC link undervoltage	Intermediate circuit DC voltage is not sufficient because of a missing supply phase, blown fuse or fault in the rectifier bridge.	Check supply cabling, fuses and switchgear. With parallel-connected modules, check the auxiliary code (format XXXY YYZZ). “Y YY” specifies through which BCU control unit channel the fault was received.
3280	Standby timeout	Automatic restart failed (see section Automatic restart on page 69).	Check the condition of the supply (voltage, cabling, fuses, switchgear).
3291	BU DC link difference	Difference in DC voltages between parallel-connected inverter modules.	Check the auxiliary code (format XXXY YYZZ). “XXX” specifies the source of the first error (see “YYY”). “YYY” specifies the module through which BCU control unit channel the fault was received (1 : Channel 1, 2 : Channel 2, 4 : Channel 3, 8 : Channel 4, ..., 800 : Channel 12).
3381	Output phase loss Programmable fault: 31.19 Motor phase loss	Motor circuit fault due to missing motor connection (all three phases are not connected).	Connect motor cable.
3385	Autophasing	Autophasing routine (see section Autophasing on page 60) has failed.	Try other autophasing modes (see parameter 21.13 Autophasing mode) if possible. If the Turning with Z-pulse mode is selected, check the zero pulse given by the encoder. Check that the motor ID run has been successfully completed. Clear parameter 98.15 Position offset user . Check that the encoder is not slipping on the motor shaft. Check that the motor is not already turning when the autophasing routine starts. Check the setting of parameter 99.03 Motor type .
4000	Motor cable overload	Calculated motor cable temperature has exceeded warning limit.	Check the settings of parameters 35.61 and 35.62 . Check the dimensioning of the motor cable in regard to required load.

Code (hex)	Fault	Cause	What to do
4210	IGBT overtemperature	Estimated drive IGBT temperature is excessive.	Check ambient conditions. Check air flow and fan operation. Check heatsink fins for dust pick-up. Check motor power against drive power.
4290	Cooling	Drive module temperature is excessive.	Check ambient temperature. If it exceeds 40 °C (104 °F), ensure that load current does not exceed derated load capacity of drive. See appropriate <i>Hardware manual</i> . Check drive module cooling air flow and fan operation. Check inside of cabinet and heatsink of drive module for dust pick-up. Clean whenever necessary.
42F1	IGBT temperature	Drive IGBT temperature is excessive.	Check ambient conditions. Check air flow and fan operation. Check heatsink fins for dust pick-up. Check motor power against drive power.
4310	Excess temperature	Power unit module temperature is excessive.	See A4B0 Excess temperature (page 485).
4380	Excess temperature difference	High temperature difference between the IGBTs of different phases.	See A4B1 Excess temperature difference (page 486).
4381	PCB space cooling	Temperature difference between ambient and drive module PCB space is excessive.	See A4B2 PCB space cooling (page 486).
4981	External temperature 1 (Editable message text)	Measured temperature 1 has exceeded fault limit.	Check the value of parameter 35.02 Measured temperature 1 . Check the cooling of the motor (or other equipment whose temperature is being measured). Check the value of parameter 35.12 Temperature 1 fault limit .

Code (hex)	Fault	Cause	What to do
4982	External temperature 2 (Editable message text)	Measured temperature 2 has exceeded fault limit.	Check the value of parameter 35.03 Measured temperature 2 . Check the cooling of the motor (or other equipment whose temperature is being measured). Check the value of parameter 35.22 Temperature 2 fault limit .
4991	Safe motor temperature 1 (Editable message text)	The temperature monitoring module installed in slot 1 indicates overtemperature.	Check the cooling of the motor. Check the motor load and drive ratings. Check the wiring of the temperature sensor. Repair wiring if faulty. Measure the resistance of the sensor. Replace sensor if faulty.
4992	Safe motor temperature 2 (Editable message text)	The temperature monitoring module installed in slot 2 indicates overtemperature.	
4993	Safe motor temperature 3 (Editable message text)	The temperature monitoring module installed in slot 3 indicates overtemperature.	
5080	Fan	Cooling fan feedback missing.	See A581 Fan (page 487).
5081	Auxiliary fan broken	An auxiliary cooling fan (connected to the fan connectors on the control unit) is stuck or disconnected.	Check the auxiliary code. The auxiliary code identifies the fan (1 : Auxiliary fan 1, 2 : Auxiliary fan 2). Check auxiliary fan(s) and connection(s). Replace faulty fan. Make sure the front cover of the drive module is in place and tightened. If the commissioning of the drive requires that the cover is off, activate parameter 31.36 Aux fan fault bypass within 2 minutes from control unit reboot to temporarily suppress the fault.

Code (hex)	Fault	Cause	What to do
5090	STO hardware failure	Safe torque off hardware failure.	<p>Contact your local ABB representative, quoting the auxiliary code. The code contains location information, especially with parallel-connected inverter modules. When converted into a 32-bit binary number, the bits of the code indicate the following:</p> <p>31...28: Number of faulty inverter module (0...11 decimal). 1111: STO_ACT states of control unit and inverter modules in conflict</p> <p>27: STO_ACT state of inverter modules</p> <p>26: STO_ACT state of control unit</p> <p>25: STO1 of control unit</p> <p>24: STO2 of control unit</p> <p>23...12: STO1 of inverter modules</p> <p>12...1 (Bits of non-existing modules set to 1)</p> <p>11...0: STO2 of inverter modules</p> <p>12...1 (Bits of non-existing modules set to 1)</p>
5091	Safe torque off Programmable fault: 31.22 STO indication run/stop	Safe torque off function is active, i.e. safety circuit signal(s) connected to connector XSTO is broken during start or run.	Check safe torque off circuit connections. For more information, see appropriate drive hardware manual and description of parameter 31.22 STO indication run/stop (page 268).
5092	PU logic error	Power unit memory has cleared.	Cycle the power to the drive. If the control unit is externally powered, also reboot the control unit (using parameter 96.08 Control board boot) or by cycling its power. If the problem persists, contact your local ABB representative.

Code (hex)	Fault	Cause	What to do
5093	Rating ID mismatch	The hardware of the drive does not match the information stored in the memory unit. This may occur eg. after a firmware update or memory unit replacement.	<p>Cycle the power to the drive.</p> <p>Check the auxiliary code. The auxiliary code categories are as follows:</p> <ul style="list-style-type: none"> 1 = PU and CU ratings not the same. Rating ID has changed. 2 = Parallel connection rating ID has changed. 3 = PU types not the same in all power units. 4 = Parallel connection rating ID is active in a single power unit setup. 5 = It is not possible to implement the selected rating with the current PUs. 6 = PU rating ID is 0. 7 = Reading PU rating ID or PU type failed on PU connection. <p>With parallel connection faults, the format of the auxiliary code is 0X0Y. "Y" indicates the auxiliary code category, "X" indicates the first faulty PU channel in hexadecimal (1...C).</p>
5094	Measurement circuit temperature	Problem with internal temperature measurement of the drive.	See A5EA Measurement circuit temperature (page 488).

Code (hex)	Fault	Cause	What to do
5681	PU communication	The way the control unit is powered does not correspond to parameter setting.	Check setting of 95.04 Control board supply .
		Communication errors detected between the drive control unit and the power unit.	Check the connection between the control unit and the power unit. Check the auxiliary code (format XXXY YYZZ). With parallel-connected modules, “Y YY” specifies the affected BCU control unit channel (0 : broadcast). “ZZ” specifies the error source (1 : Transmitter side [link error], 2 : Transmitter side [no communication], 3 : Receiver side [link error], 4 : Receiver side [no communication], 5 : Transmitter FIFO error [see “XXX”], 6 : Module [xINT board] not found, 7 : BAMU board not found). “XXX” specifies the transmitter FIFO error code (1 : Internal error [invalid call parameter], 2 : Internal error [configuration not supported], 3 : Transmission buffer full).
5682	Power unit lost	Connection between the drive control unit and the power unit is lost.	Check the connection between the control unit and the power unit.
5690	PU communication internal	Internal communication error.	Contact your local ABB representative.
5691	Measurement circuit ADC	Measurement circuit fault.	Contact your local ABB representative, quoting the auxiliary code.
5692	PU board powerfail	Power unit power supply failure.	Check the auxiliary code (format ZZZY YYXX). “YY Y” specifies the affected inverter module (0...C , always 0 for ZCU control units). “XX” specifies the affected power supply (1 : Power supply 1, 2 : Power supply 2).
5693	Measurement circuit DFF	Measurement circuit fault.	Contact your local ABB representative, quoting the auxiliary code.
5694	PU communication configuration	Version check cannot find a matching power unit FPGA logic.	Contact your local ABB representative.

Code (hex)	Fault	Cause	What to do
5696	PU state feedback	State feedback from output phases does not match control signals.	Contact your local ABB representative, quoting the auxiliary code.
5697	Charging feedback	The charging switch and DC switch were operated out of sequence, or a start command was issued before the unit was ready.	The normal power-up sequence is: 1. Close charging switch. 2. After charging finishes (charging OK lamp lights), close DC switch. 3. Open charging switch.
		Charging circuit fault.	Check the charging circuit. With a frame R6i/R7i inverter module, the auxiliary code "FA" indicates that the charging contactor status feedback does not match the control signal. With parallel-connected frame R8i modules, the auxiliary code (format XX00), "XX" specifies the affected BCU control unit channel.
5698	Unknown power unit fault	Unidentified power unit logic fault.	Check power unit logic and firmware compatibility. Contact your local ABB representative.
6000	Internal SW error	Internal error.	Contact your local ABB representative, quoting the auxiliary code.
6181	FPGA version incompatible	Firmware and FPGA file version in the power unit are incompatible.	Reboot the control unit (using parameter 96.08 Control board boot) or by cycling power. If the problem persists, contact your local ABB representative.
6306	FBA A mapping file	Fieldbus adapter A mapping file read error.	Contact your local ABB representative.
6307	FBA B mapping file	Fieldbus adapter B mapping file read error.	Contact your local ABB representative.
6481	Task overload	Internal fault.	Reboot the control unit (using parameter 96.08 Control board boot) or by cycling power. If the problem persists, contact your local ABB representative.

Code (hex)	Fault	Cause	What to do
6487	Stack overflow	Internal fault.	Reboot the control unit (using parameter 96.08 Control board boot) or by cycling power. If the problem persists, contact your local ABB representative.
64A1	Internal file load	File read error.	Reboot the control unit (using parameter 96.08 Control board boot) or by cycling power. If the problem persists, contact your local ABB representative.
64A2	Internal record load	Internal record load error.	Contact your local ABB representative.
64A3	Application loading	Application file incompatible or corrupted.	Check the auxiliary code. See actions for each code below.
	8006	Not enough memory for the application.	
	8007	The application contains the wrong library version.	
	800A	The application contains an unknown target (system) library function.	
64A5	Licensing fault	Running the control program is prevented either because a restrictive license exists, or because a required license is missing.	Record the auxiliary codes of all active licensing faults and contact your product vendor for further instructions.
64A6	Adaptive program	Error running the adaptive program.	Check the auxiliary code (format XXXX YYYY). "XXXX" specifies the number of the function block (0000 = generic error). "YYYY" indicates the problem (see actions for each code below).
	000A	Program corrupted or block non-existent	Restore the template program or download the program to the drive.
	000C	Required block input missing	Check the inputs of the block.
	000E	Program corrupted or block non-existent	Restore the template program or download the program to the drive.
	0011	Program too large.	Remove blocks until the error stops.
	0012	Program is empty.	Correct the program and download it to the drive.

Code (hex)	Fault	Cause	What to do
	001C	A nonexisting parameter or block is used in the program.	Edit the program to correct the parameter reference, or to use an existing block.
	001E	Output to parameter failed because the parameter was write-protected.	Check the parameter reference in the program. Check for other sources affecting the target parameter.
	0023	Program file incompatible with current firmware version.	Adapt the program to current block library and firmware version.
	0024		
	Other	–	Contact your local ABB representative, quoting the auxiliary code.
64B0	Memory unit detached	The memory unit was detached when the control unit was powered.	Switch off the power to the control unit and reinstall the memory unit. In case the memory unit was not actually removed when the fault occurred, check that the memory unit is properly inserted into its connector and its mounting screw is tight. Reboot the control unit (using parameter 96.08 Control board boot) or by cycling power. If the problem persists, contact your local ABB representative.
64B1	Internal SSW fault	Internal fault.	Reboot the control unit (using parameter 96.08 Control board boot) or by cycling power. If the problem persists, contact your local ABB representative.
64B2	User set fault	Loading of user parameter set failed because <ul style="list-style-type: none"> • requested set does not exist • set is not compatible with control program • drive was switched off during loading. 	Ensure that a valid user parameter set exists. Reload if uncertain.
64E1	Kernel overload	Operating system error.	Reboot the control unit (using parameter 96.08 Control board boot) or by cycling power. If the problem persists, contact your local ABB representative.
6581	Parameter system	Parameter load or save failed.	Try forcing a save using parameter 96.07 Parameter save manually . Retry.

Code (hex)	Fault	Cause	What to do
65A1	FBA A parameter conflict	The drive does not have a functionality requested by PLC, or requested functionality has not been activated.	Check PLC programming. Check settings of parameter groups 50 Fieldbus adapter (FBA) and 51 FBA A settings .
65A2	FBA B parameter conflict	The drive does not have a functionality requested by PLC, or requested functionality has not been activated.	Check PLC programming. Check settings of parameter groups 50 Fieldbus adapter (FBA) and 54 FBA B settings .
65B1	Reference source parametrization	A reference source is simultaneously connected to multiple parameters with different units.	See A6DA Reference source parametrization (page 491).
6681	EFB comm loss Programmable fault: 58.14 Communication loss action	Communication break in embedded fieldbus (EFB) communication.	Check the status of the fieldbus master (online/offline/error etc.). Check cable connections to the XD2D connector on the control unit.
6682	EFB config file	Embedded fieldbus (EFB) configuration file could not be read.	Contact your local ABB representative.
6683	EFB invalid parameterization	Embedded fieldbus (EFB) parameter settings inconsistent or not compatible with selected protocol.	Check the settings in parameter group 58 Embedded fieldbus .
6684	EFB load fault	Embedded fieldbus (EFB) protocol firmware could not be loaded.	Contact your local ABB representative.
		Version mismatch between EFB protocol firmware and drive firmware.	
6881	Text data overflow	Internal fault.	Reset the fault. Contact your local ABB representative if the fault persists.
6882	Text 32-bit table overflow	Internal fault.	Reset the fault. Contact your local ABB representative if the fault persists.
6883	Text 64-bit table overflow	Internal fault.	Reset the fault. Contact your local ABB representative if the fault persists.

Code (hex)	Fault	Cause	What to do
6885	Text file overflow	Internal fault.	Reset the fault. Contact your local ABB representative if the fault persists.
7080	Option module comm loss	Communication between drive and an option module is lost.	Check that all option modules are properly seated in their slots. Check that all option modules or slot connectors are not damaged. To pinpoint the problem, try installing the modules into different slots one at a time.
7081	Control panel loss Programmable fault: 49.05 Communication loss action	Control panel (or PC tool) has stopped communicating.	Check PC tool or control panel connection. Check control panel connector. Disconnect and reconnect the control panel. Check the auxiliary code. The code specifies the I/O port used as follows: 0 : Panel, 1 : Fieldbus interface A, 2 : Fieldbus interface B, 3 : Ethernet, 4 : D2D/EFB port).
7082	Ext I/O comm loss	The I/O extension module types specified by parameters do not match the detected configuration.	Check the auxiliary code (format XXYY YYYY). "XX" specifies the number of the I/O extension module (01 : parameter group 14 I/O extension module 1 , 02 : 15 I/O extension module 2 , . "YY YYYY" indicates the problem (see actions for each code below).
	00 0001	Communication with module failed.	Check that the module is properly seated in its slot. Check that the module and the slot connector is not damaged. Try installing the module into another slot.
	00 0002	Module not found.	Check the type and location settings of the modules (parameters 14.01/14.02 or 15.01/15.02).
	00 0003	Configuration of module failed.	
	00 0004	Configuration of module failed.	Check that the module is properly seated in its slot. Check that the module and the slot connector is not damaged. Try installing the module into another slot.

Code (hex)	Fault	Cause	What to do
7083	Panel reference conflict	Use of saved control panel reference in multiple control modes attempted.	The control panel reference can only be saved for one reference type at a time. Consider the possibility of using a copied reference instead of saved reference (see the reference selection parameter).
7084	Panel/PC tool version conflict	The current version of the control panel and/or PC tool does not support a function. (For example, older panel versions cannot be used as a source of external reference.)	Update control panel and/or PC tool. Contact your local ABB representative if necessary.
7121	Motor stall Programmable fault: 31.24 Stall function	Motor is operating in stall region because of e.g. excessive load or insufficient motor power.	Check motor load and drive ratings. Check fault function parameters.
7181	Brake resistor	Brake resistor broken or not connected.	Check that a brake resistor has been connected. Check the condition of the brake resistor. Check the dimensioning of the brake resistor.
7184	Brake resistor wiring	Brake resistor short circuit or brake chopper control fault.	Check brake chopper and brake resistor connection. Ensure brake resistor is not damaged. After correcting the cause of the fault, reboot the control unit (using parameter 96.08 Control board boot) or by cycling power.
7191	BC short circuit	Short circuit in brake chopper IGBT.	Ensure brake resistor is connected and not damaged. Check the electrical specifications of the brake resistor against the <i>Hardware manual</i> . Replace brake chopper (if replaceable). After correcting the cause of the fault, reboot the control unit (using parameter 96.08 Control board boot) or by cycling power.

Code (hex)	Fault	Cause	What to do
7192	BC IGBT excess temperature	Brake chopper IGBT temperature has exceeded internal fault limit.	<p>Let chopper cool down.</p> <p>Check for excessive ambient temperature.</p> <p>Check for cooling fan failure.</p> <p>Check for obstructions in the air flow.</p> <p>Check the dimensioning and cooling of the cabinet.</p> <p>Check that braking cycle meets allowed limits.</p> <p>Check that drive supply AC voltage is not excessive.</p>
71A2	Mechanical brake closing failed Programmable fault: 44.17 Brake fault function	Mechanical brake control fault. Activated eg. if brake acknowledgement is not as expected during brake closing.	<p>Check mechanical brake connection.</p> <p>Check mechanical brake settings in parameter group 44 Mechanical brake control.</p> <p>Check that acknowledgement signal matches actual status of brake.</p>
71A3	Mechanical brake opening failed Programmable fault: 44.17 Brake fault function	Mechanical brake control fault. Activated eg. if brake acknowledgement is not as expected during brake opening.	<p>Check mechanical brake connection.</p> <p>Check mechanical brake settings in parameter group 44 Mechanical brake control.</p> <p>Check that acknowledgement signal matches actual status of brake.</p>
71A5	Mechanical brake opening not allowed Programmable fault: 44.17 Brake fault function	Open conditions of mechanical brake cannot be fulfilled (for example, brake has been prevented from opening by parameter 44.11 Keep brake closed).	<p>Check mechanical brake settings in parameter group 44 Mechanical brake control (especially 44.11 Keep brake closed).</p> <p>Check that acknowledgement signal (if used) matches actual status of brake.</p>
		In an encoderless application, the brake is kept closed by a brake close request (either from parameter 44.12 Brake close request or from an FSO-xx safety functions module) against a modulating drive for longer than 5 seconds.	<p>Check the source signal selected by parameter 44.12 Brake close request.</p> <p>Check the safety circuits connected to the FSO-xx safety functions module.</p>

Code (hex)	Fault	Cause	What to do
71B1	Motor fan Programmable fault: 35.106 DOL starter event type	No feedback received from external fan.	Check external fan (or other equipment controlled) by the logic. Check settings of parameters 35.100...35.106 .
7301	Motor speed feedback Programmable fault: 90.45 Motor feedback fault	No motor speed feedback received.	See A7B0 Motor speed feedback (page 495).
7310	Overspeed	Motor is turning faster than highest allowed speed due to incorrectly set minimum/maximum speed, insufficient braking torque or changes in load when using torque reference.	Check minimum/maximum speed settings, parameters 30.11 Minimum speed and 30.12 Maximum speed . Check adequacy of motor braking torque. Check applicability of torque control. Check need for brake chopper and resistor(s).
		Incorrect estimated speed.	Check the status of motor current measurement. Perform a Normal , Advanced or Advanced Standstill ID run instead of, for example, a Reduced or Standstill ID run. See parameter 99.13 ID run requested (page 429).
7380	Encoder internal	Internal fault.	Contact your local ABB representative.
7381	Encoder Programmable fault: 90.45 Motor feedback fault	Encoder feedback fault.	See A7E1 Encoder (page 496).
73A0	Speed feedback configuration	Speed feedback configuration incorrect.	See A797 Speed feedback configuration (page 492).
73A1	Load feedback Programmable fault: 90.55 Load feedback fault	No load feedback received.	Check the auxiliary code (format XXYY ZZZZ). “XX” specifies the number of the encoder interface module (01 : 91.11/91.12 , 02 : 91.13/91.14), “YY” specifies the encoder (01 : 92 Encoder 1 configuration , 02 : 93 Encoder 2 configuration). “ZZZZ” indicates the problem (see actions for each code below).
	0001	Load gear definition invalid or outside limits.	Check load gear settings (90.53 and 90.54).
	0002	Feed constant definition invalid or outside limits.	Check feed constant settings (90.63 and 90.64).

Code (hex)	Fault	Cause	What to do
	0003	Motor/load gear definition invalid or outside limits.	Check motor/load gear settings (90.61 and 90.62).
	0004	Encoder not configured.	Check encoder settings (92 Encoder 1 configuration or 93 Encoder 2 configuration). Use parameter 91.10 Encoder parameter refresh) to validate any changes in the settings.
	0005	Encoder stopped working.	Check encoder status.
73B0	Emergency ramp failed	Emergency stop did not finish within expected time.	Check the settings of parameters 31.32 Emergency ramp supervision and 31.33 Emergency ramp supervision delay . Check the predefined ramp times (23.11...23.19 for mode Off1, 23.23 for mode Off3).
73B1	Stop failed	Ramp stop did not finish within expected time.	Check the settings of parameters 31.37 Ramp stop supervision and 31.38 Ramp stop supervision delay . Check the predefined ramp times in parameter group 23 Speed reference ramp .
7510	FBA A communication Programmable fault: 50.02 FBA A comm loss func	Cyclical communication between drive and fieldbus adapter module A or between PLC and fieldbus adapter module A is lost.	Check status of fieldbus communication. See user documentation of fieldbus interface. Check settings of parameter groups 50 Fieldbus adapter (FBA) , 51 FBA A settings , 52 FBA A data in and 53 FBA A data out . Check cable connections. Check if communication master is able to communicate.
7520	FBA B communication Programmable fault: 50.32 FBA B comm loss func	Cyclical communication between drive and fieldbus adapter module B or between PLC and fieldbus adapter module B is lost.	Check status of fieldbus communication. See user documentation of fieldbus interface. Check settings of parameter group 50 Fieldbus adapter (FBA) . Check cable connections. Check if communication master is able to communicate.

Code (hex)	Fault	Cause	What to do
7582	MF comm loss Programmable fault: 60.09 M/F comm loss function	Master/follower communication is lost.	See A7CB MF comm loss (page 496).
7583	Line side unit faulted	The supply unit (or other converter) connected to the inverter unit has generated a fault.	Check fault status of supply unit (or other converter). Refer to the firmware manual of the supply unit.
80A0	AI supervision Programmable fault: 12.03 AI supervision function	An analog signal is outside the limits specified for the analog input.	Check the auxiliary code (format XXXX XYZZ). “Y” specifies the location of the input (0 : Control unit, 1 : I/O extension module 1, 2 : I/O extension module 2, 3 : I/O extension module 3). “ZZ” specifies the limit (01 : AI1 under minimum, 02 : AI1 above maximum, 03 : AI2 under minimum, 04 : AI2 above maximum). Check signal level at the analog input. Check the wiring connected to the input. Check the minimum and maximum limits of the input in parameter group 12 Standard AI .
80B0	Signal supervision (Editable message text) Programmable fault: 32.06 Supervision 1 action	Fault generated by the signal supervision 1 function.	Check the source of the fault (parameter 32.07 Supervision 1 signal).
80B1	Signal supervision 2 (Editable message text) Programmable fault: 32.16 Supervision 2 action	Fault generated by the signal supervision 2 function.	Check the source of the fault (parameter 32.17 Supervision 2 signal).
80B2	Signal supervision 3 (Editable message text) Programmable fault: 32.26 Supervision 3 action	Fault generated by the signal supervision 3 function.	Check the source of the fault (parameter 32.27 Supervision 3 signal).
9081	External fault 1 (Editable message text) Programmable fault: 31.01 External event 1 source 31.02 External event 1 type	Fault in external device 1.	Check the external device. Check setting of parameter 31.01 External event 1 source .
9082	External fault 2 (Editable message text) Programmable fault: 31.03 External event 2 source 31.04 External event 2 type	Fault in external device 2.	Check the external device. Check setting of parameter 31.03 External event 2 source .

Code (hex)	Fault	Cause	What to do
9083	External fault 3 (Editable message text) Programmable fault: 31.05 External event 3 source 31.06 External event 3 type	Fault in external device 3.	Check the external device. Check setting of parameter 31.05 External event 3 source .
9084	External fault 4 (Editable message text) Programmable fault: 31.07 External event 4 source 31.08 External event 4 type	Fault in external device 4.	Check the external device. Check setting of parameter 31.07 External event 4 source .
9085	External fault 5 (Editable message text) Programmable fault: 31.09 External event 5 source 31.10 External event 5 type	Fault in external device 5.	Check the external device. Check setting of parameter 31.09 External event 5 source .
FA81	Safe torque off 1 loss	Safe torque off function is active, ie. STO circuit 1 is broken.	<p>Check safety circuit connections. For more information, see appropriate drive hardware manual and description of parameter 31.22 STO indication run/stop (page 268).</p> <p>Check the auxiliary code, The code contains location information, especially with parallel-connected inverter modules. When converted into a 32-bit binary number, the bits of the code indicate the following:</p> <p>31...28: Number of faulty inverter module (0...11 decimal). 1111: STO_ACT states of control unit and inverter modules in conflict</p> <p>27: STO_ACT state of inverter modules</p> <p>26: STO_ACT state of control unit</p> <p>25: STO1 of control unit</p> <p>24: STO2 of control unit</p> <p>23...12: STO1 of inverter modules</p> <p>12...1 (Bits of non-existing modules set to 1)</p> <p>11...0: STO2 of inverter modules</p> <p>12...1 (Bits of non-existing modules set to 1)</p>
FA82	Safe torque off 2 loss	Safe torque off function is active, ie. STO circuit 2 is broken.	

Code (hex)	Fault	Cause	What to do
FB11	Memory unit missing	No memory unit is attached to the control unit.	Power down the control unit. Check that the memory unit is properly inserted into the control unit.
		The memory unit attached to the control unit is empty.	Power down the control unit. Attach a memory unit (with the appropriate firmware) to the control unit.
FB12	Memory unit incompatible	The memory unit attached to the control unit is incompatible.	Power down the control unit. Attach a compatible memory unit.
FB13	Memory unit FW incompatible	The firmware on the attached memory unit is incompatible with the drive.	Power down the control unit. Attach a memory unit with compatible firmware.
FB14	Memory unit FW load failed	The firmware on the attached memory unit could not be loaded to the drive.	Power down the control unit. Check that the memory unit is properly inserted into the control unit. If the problem persists, replace the memory unit.
FF61	ID run	Motor ID run was not completed successfully.	Check the nominal motor values in parameter group 99 Motor data . Check that no external control system is connected to the drive. Cycle the power to the drive (and its control unit, if powered separately). Check that the motor shaft is not locked. Check the auxiliary code. The second number of the code indicates the problem (see actions for each code below).
	0001	Maximum current limit too low.	Check settings of parameters 99.06 Motor nominal current and 30.17 Maximum current . Make sure that 30.17 > 99.06 . Check that the drive is dimensioned correctly according to the motor.

Code (hex)	Fault	Cause	What to do
	0002	Maximum speed limit or calculated field weakening point too low.	<p>Check settings of parameters</p> <ul style="list-style-type: none"> • 30.11 Minimum speed • 30.12 Maximum speed • 99.07 Motor nominal voltage • 99.08 Motor nominal frequency • 99.09 Motor nominal speed. <p>Make sure that</p> <ul style="list-style-type: none"> • $30.12 > (0.55 \times 99.09) > (0.50 \times \text{synchronous speed})$ • $30.11 \leq 0$, and • supply voltage $\geq (0.66 \times 99.07)$.
	0003	Maximum torque limit too low.	<p>Check settings of parameter 99.12 Motor nominal torque, and the torque limits in group 30 Limits.</p> <p>Make sure that the maximum torque limit in force is greater than 100%.</p>
	0004	Current measurement calibration did not finish within reasonable time.	Contact your local ABB representative.
	0005...0008	Internal error.	Contact your local ABB representative.
	0009	(Asynchronous motors only) Acceleration did not finish within reasonable time.	Contact your local ABB representative.
	000A	(Asynchronous motors only) Deceleration did not finish within reasonable time.	Contact your local ABB representative.
	000B	(Asynchronous motors only) Speed dropped to zero during ID run.	Contact your local ABB representative.
	000C	(Permanent magnet motors only) First acceleration did not finish within reasonable time.	Contact your local ABB representative.
	000D	(Permanent magnet motors only) Second acceleration did not finish within reasonable time.	Contact your local ABB representative.
	000E...0010	Internal error.	Contact your local ABB representative.

Code (hex)	Fault	Cause	What to do
FF7E	Follower	A follower drive has tripped.	Check the auxiliary code. Add 2 to the code to find out the node address of the faulted drive. Correct the fault in the follower drive.
FF81	FB A force trip	A fault trip command has been received through fieldbus adapter A.	Check the fault information provided by the PLC.
FF82	FB B force trip	A fault trip command has been received through fieldbus adapter B.	Check the fault information provided by the PLC.
FF8E	EFB force trip	A fault trip command has been received through the embedded fieldbus interface.	Check the fault information provided by the Modbus controller.

10

Fieldbus control through the embedded fieldbus interface (EFB)

What this chapter contains

The chapter describes how the drive can be controlled by external devices over a communication network (fieldbus) using the embedded fieldbus interface.

System overview

The drive can be connected to an external control system through a communication link using either a fieldbus adapter or the embedded fieldbus interface.

The embedded fieldbus interface supports the Modbus RTU protocol. The drive control program can handle 10 Modbus registers in a 10-millisecond time level. For example, if the drive receives a request to read 20 registers, it will start its response within 22 ms of receiving the request – 20 ms for processing the request and 2 ms overhead for handling the bus. The actual response time depends on other factors as well, such as the baud rate (a parameter setting in the drive).

The drive can be set to receive all of its control information through the fieldbus interface, or the control can be distributed between the embedded fieldbus interface and other available sources, for example, digital and analog inputs.

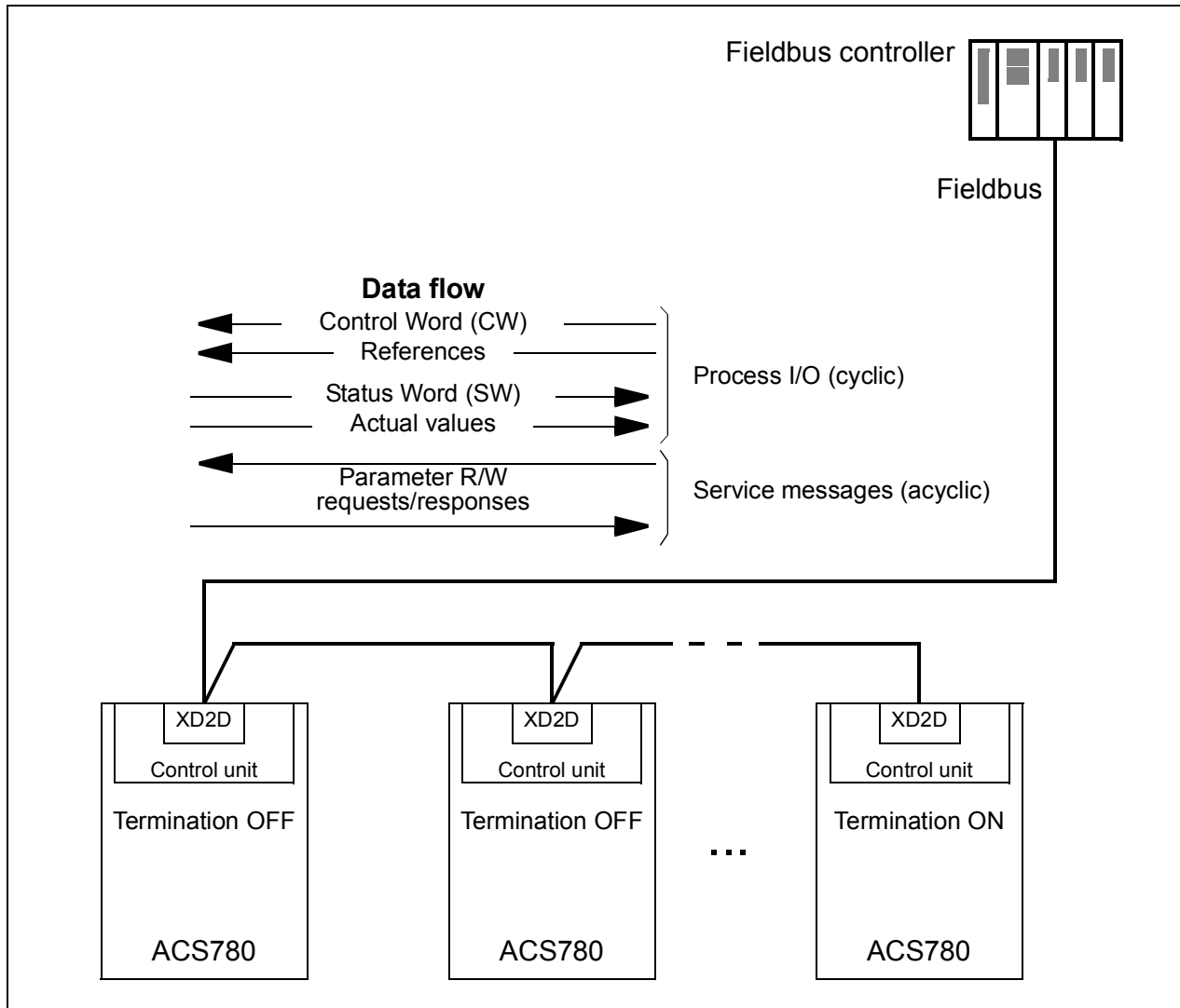

Connecting the fieldbus to the drive

Connect the fieldbus to terminal XD2D on the control unit of the drive. See the appropriate *Hardware Manual* for more information on the connection, chaining and termination of the link.

Note: If the XD2D connector is reserved by the embedded fieldbus interface (parameter [58.01 Protocol enable](#) is set to [Modbus RTU](#)), the drive-to-drive link functionality is automatically disabled.

Setting up the embedded fieldbus interface

Set the drive up for the embedded fieldbus communication with the parameters shown in the table below. The **Setting for fieldbus control** column gives either the value to use or the default value. The **Function/Information** column gives a description of the parameter.

Parameter	Setting for fieldbus control	Function/Information
COMMUNICATION INITIALIZATION		
58.01 <i>Protocol enable</i>	<i>Modbus RTU</i>	Initializes embedded fieldbus communication. Drive-to-drive link operation is automatically disabled.
EMBEDDED MODBUS CONFIGURATION		
58.03 <i>Node address</i>	1 (default)	Node address. There must be no two nodes with the same node address online.
58.04 <i>Baud rate</i>	<i>19.2 kbps</i> (default)	Defines the communication speed of the link. Use the same setting as in the master station.
58.05 <i>Parity</i>	<i>8 EVEN 1</i> (default)	Selects the parity and stop bit setting. Use the same setting as in the master station.
58.14 <i>Communication loss action</i>	<i>Fault</i> (default)	Defines the action taken when a communication loss is detected.
58.15 <i>Communication loss mode</i>	<i>Cw / Ref1 / Ref2</i> (default)	Enables/disables communication loss monitoring and defines the means for resetting the counter of the communication loss delay.
58.16 <i>Communication loss time</i>	3.0 s (default)	Defines the timeout limit for the communication monitoring.
58.17 <i>Transmit delay</i>	0 ms (default)	Defines a response delay for the drive.
58.25 <i>Control profile</i>	<i>ABB Drives</i> (default), <i>Transparent</i>	Selects the control profile used by the drive. See section Basics of the embedded fieldbus interface (page 533).
58.26 <i>EFB ref1 type</i> 58.29 <i>EFB act2 type</i>	<i>Speed or frequency</i> , <i>Transparent</i> , <i>General</i> , <i>Torque</i> , <i>Speed</i> , <i>Frequency</i>	Selects the reference and actual value types. With the <i>Speed or frequency</i> setting, the type is selected automatically according to the currently active drive control mode.
58.30 <i>EFB status word transparent source</i>	<i>Other</i>	Defines the source of status word when 58.25 Control profile = <i>Transparent</i> .
58.31 <i>EFB act1 transparent source</i>	<i>Other</i>	Defines the source of actual value 1 when 58.28 EFB act1 type = <i>Transparent</i> or <i>General</i> .

Parameter	Setting for fieldbus control	Function/Information
58.32 EFB act2 transparent source	<i>Other</i>	Defines the source of actual value 2 when 58.29 EFB act2 type = <i>Transparent</i> or <i>General</i> .
58.33 Addressing mode	<i>Mode 1</i>	Defines the mapping between parameters and holding registers in the 400001...465536 (100...65535) Modbus register range.
58.34 Word order	<i>LO-HI</i> (default)	Defines the order of the data words in the Modbus message frame.
58.101 Data I/O 1 ... 58.124 Data I/O 24	For example, the default settings (I/Os 1...6 contain the control word, the status word, two references and two actual values) <i>RO/DIO control word, AO1 data storage and AO2 data storage.</i>	Define the address of the drive parameter which the Modbus master accesses when it reads from or writes to the register address corresponding to Modbus In/Out parameters. Select the parameters that you want to read or write through the Modbus I/O words. These settings write the incoming data into storage parameters 10.99 RO/DIO control word , 13.91 AO1 data storage and 13.92 AO2 data storage .
58.06 Communication control	<i>Refresh settings</i>	Validates the settings of the configuration parameters.

The new settings will take effect when the drive is powered up the next time, or when they are validated by parameter [58.06 Communication control](#).

Setting the drive control parameters

After the embedded fieldbus interface has been set up, check and adjust the drive control parameters listed in the table below. The **Setting for fieldbus control** column gives the value or values to use when the embedded fieldbus signal is the desired source or destination for that particular drive control signal. The **Function/Information** column gives a description of the parameter.

Parameter	Setting for fieldbus control	Function/Information
CONTROL COMMAND SOURCE SELECTION		
20.01 Ext1 commands	<i>Embedded fieldbus</i>	Selects fieldbus as the source for the start and stop commands when EXT1 is selected as the active control location.
20.02 Ext2 commands	<i>Embedded fieldbus</i>	Selects fieldbus as the source for the start and stop commands when EXT2 is selected as the active control location.

Parameter	Setting for fieldbus control	Function/Information
SPEED REFERENCE SELECTION		
22.11 Speed ref1 source	EFB ref1 or EFB ref2	Selects a reference received through the embedded fieldbus interface as speed reference 1.
22.12 Speed ref2 source	EFB ref1 or EFB ref2	Selects a reference received through the embedded fieldbus interface as speed reference 2.
TORQUE REFERENCE SELECTION		
26.11 Torque ref1 source	EFB ref1 or EFB ref2	Selects a reference received through the embedded fieldbus interface as torque reference 1.
26.12 Torque ref2 source	EFB ref1 or EFB ref2	Selects a reference received through the embedded fieldbus interface as torque reference 2.
FREQUENCY REFERENCE SELECTION		
28.11 Frequency ref1 source	EFB ref1 or EFB ref2	Selects a reference received through the embedded fieldbus interface as frequency reference 1.
28.12 Frequency ref2 source	EFB ref1 or EFB ref2	Selects a reference received through the embedded fieldbus interface as frequency reference 2.
OTHER SELECTIONS		
EFB references can be selected as the source at virtually any signal selector parameter by selecting Other , then either 03.09 EFB reference 1 or 03.10 EFB reference 2 .		
CONTROL OF RELAY OUTPUTS, ANALOG OUTPUTS AND DIGITAL INPUT/OUTPUTS		
10.24 RO1 source	RO/DIO control word bit0	Connects bit 0 of storage parameter 10.99 RO/DIO control word to relay output RO1.
10.27 RO2 source	RO/DIO control word bit1	Connects bit 1 of storage parameter 10.99 RO/DIO control word to relay output RO2.
10.30 RO3 source	RO/DIO control word bit2	Connects bit 2 of storage parameter 10.99 RO/DIO control word to relay output RO3.
11.05 DIO1 function 11.09 DIO2 function	Output (default)	Sets the digital input/output to output mode.
11.06 DIO1 output source	RO/DIO control word bit8	Connects bit 8 of storage parameter 10.99 RO/DIO control word to digital input/output DIO1.
11.10 DIO2 output source	RO/DIO control word bit9	Connects bit 9 of storage parameter 10.99 RO/DIO control word to digital input/output DIO2.

532 *Fieldbus control through the embedded fieldbus interface (EFB)*

Parameter	Setting for fieldbus control	Function/Information
13.12 AO1 source	AO1 data storage	Connects storage parameter 13.91 AO1 data storage to analog output AO1.
13.22 AO2 source	AO2 data storage	Connects storage parameter 13.92 AO2 data storage to analog output AO2.
SYSTEM CONTROL INPUTS		
96.07 Parameter save manually	Save (reverts to Done)	Saves parameter value changes (including those made through fieldbus control) to permanent memory.

Basics of the embedded fieldbus interface

The cyclic communication between a fieldbus system and the drive consists of 16-bit data words or 32-bit data words (with the transparent control profiles).

The diagram below illustrates the operation of the embedded fieldbus interface. The signals transferred in the cyclic communication are explained further below the diagram.

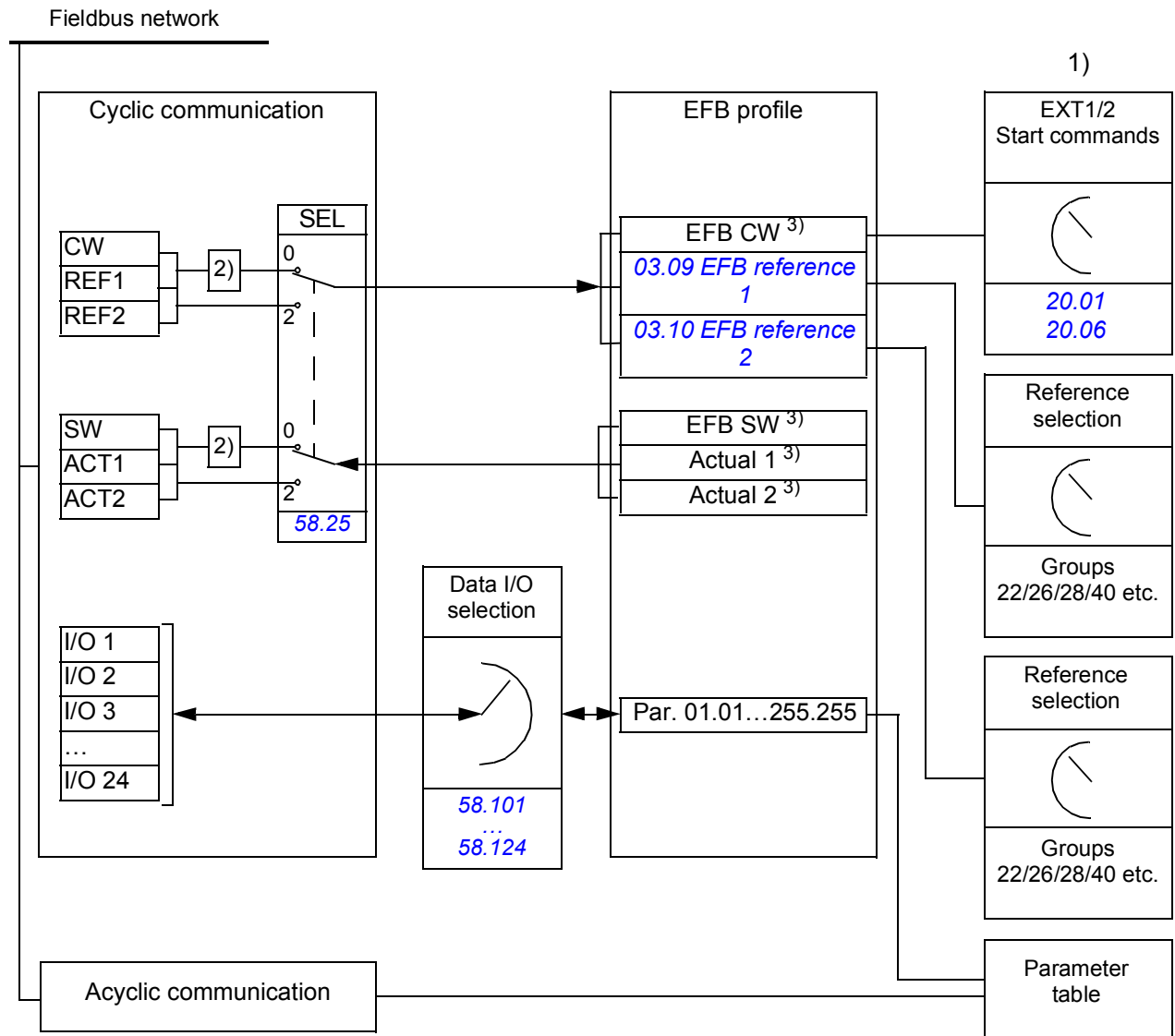

1. See also other parameters which can be controlled through fieldbus.
2. Data conversion if parameter [58.25 Control profile](#) is set to *ABB Drives*. See section [About the control profiles](#) (page 536).
3. If parameter [58.25 Control profile](#) is set to *Transparent*,
 - the sources of the status word and actual values are selected by parameters [58.30...58.32](#) (otherwise, actual values 1 and 2 are automatically selected according to reference type), and
 - the control word is displayed by [06.05 EFB transparent control word](#).

■ Control word and Status word

The Control Word (CW) is a 16-bit or 32-bit packed boolean word. It is the principal means of controlling the drive from a fieldbus system. The CW is sent by the fieldbus controller to the drive. By drive parameters, the user selects the EFB CW as the source of drive control commands (such as start/stop, emergency stop, selection between external control locations 1/2, or fault reset). The drive switches between its states according to the bit-coded instructions of the CW.

The fieldbus CW is either written to the drive as it is (see parameter [06.05 EFB transparent control word](#)), or the data is converted. See section [About the control profiles](#) (page 536).

The fieldbus Status Word (SW) is a 16-bit or 32-bit packed boolean word. It contains status information from the drive to the fieldbus controller. The drive SW is either written to the fieldbus SW as it is or the data is converted. See section [About the control profiles](#) (page 536).

■ References

EFB references 1 and 2 are 16-bit or 32-bit signed integers. The contents of each reference word can be used as the source of virtually any signal, such as the speed, frequency, torque or process reference. In embedded fieldbus communication, references 1 and 2 are displayed by [03.09 EFB reference 1](#) and [03.10 EFB reference 2](#) respectively. Whether the references are scaled or not depends on the settings of [58.26 EFB ref1 type](#) and [58.27 EFB ref2 type](#). See section [About the control profiles](#) (page 536).

■ Actual values

Fieldbus actual signals (ACT1 and ACT2) are 16-bit or 32-bit signed integers. They convey selected drive parameter values from the drive to the master. Whether the actual values are scaled or not depends on the settings of [58.28 EFB act1 type](#) and [58.29 EFB act2 type](#). See section [About the control profiles](#) (page 536).

■ Data input/outputs

Data input/outputs are 16-bit or 32-bit words containing selected drive parameter values. Parameters [58.101 Data I/O 1](#) ... [58.124 Data I/O 24](#) define the addresses from which the master either reads data (input) or to which it writes data (output).

Control of drive outputs through EFB

The address selection parameters of the data input/outputs have a setting with which the data can be written into a storage parameter in the drive. These storage parameters are readily selectable as signal sources of the drive outputs.

The desired values of the relay outputs (RO) and digital input/outputs (DIO) can be written in a 16-bit word into [10.99 RO/DIO control word](#), which is then selected as the source of those outputs. Each of the analog outputs (AO) of the drive have a

dedicated storage parameter ([13.91 AO1 data storage](#) and [13.92 AO2 data storage](#)), which are available in the source selection parameters [13.12 AO1 source](#) and [13.22 AO2 source](#).

■ Register addressing

The address field of Modbus requests for accessing holding registers is 16 bits. This allows the Modbus protocol to support addressing of 65536 holding registers.

Historically, Modbus master devices used 5-digit decimal addresses from 40001 to 49999 to represent holding register addresses. The 5-digit decimal addressing limited to 9999 the number of holding registers that could be addressed.

Modern Modbus master devices typically provide a means to access the full range of 65536 Modbus holding registers. One of these methods is to use 6-digit decimal addresses from 400001 to 465536. This manual uses 6-digit decimal addressing to represent Modbus holding register addresses.

Modbus master devices that are limited to the 5-digit decimal addressing may still access registers 400001 to 409999 by using 5-digit decimal addresses 40001 to 49999. Registers 410000 to 465536 are inaccessible to these masters.

Note: Register addresses of 32-bit parameters cannot be accessed by using 5-digit register numbers.

About the control profiles

A control profile defines the rules for data transfer between the drive and the fieldbus master, for example:

- if packed boolean words are converted and how
- how drive register addresses are mapped for the fieldbus master.

You can configure the drive to receive and send messages according to the ABB Drives profile or the Transparent profile. With the ABB Drives profile, the embedded fieldbus interface of the drive converts the control word and status word to and from the native data used in the drive. The Transparent profile involves no data conversion. The figure below illustrates the effect of the profile selection.

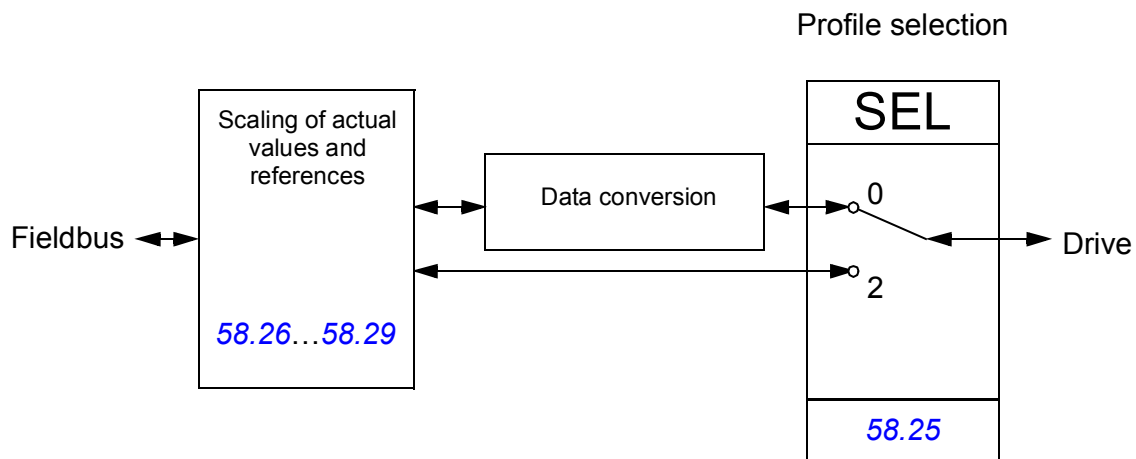

Control profile selection with parameter *58.25 Control profile*:

- (0) *ABB Drives*
- (2) *Transparent*

Note that scaling of references and actual values can be selected independent of the profile selection by parameters *58.26...58.29*.

The ABB Drives profile

■ Control Word

The table below shows the contents of the fieldbus Control Word for the ABB Drives control profile. The embedded fieldbus interface converts this word to the form in which it is used in the drive. The upper case boldface text refers to the states shown in [State transition diagram](#) on page 540.

Bit	Name	Value	STATE/Description
0	OFF1_ CONTROL	1	Proceed to READY TO OPERATE.
		0	Stop along currently active deceleration ramp. Proceed to OFF1 ACTIVE ; proceed to READY TO SWITCH ON unless other interlocks (OFF2, OFF3) are active.
1	OFF2_ CONTROL	1	Continue operation (OFF2 inactive).
		0	Emergency OFF, coast to stop. Proceed to OFF2 ACTIVE , proceed to SWITCH-ON INHIBITED .
2	OFF3_ CONTROL	1	Continue operation (OFF3 inactive).
		0	Emergency stop, stop within time defined by drive parameter. Proceed to OFF3 ACTIVE; proceed to SWITCH-ON INHIBITED. Warning: Ensure that the motor and driven machine can be stopped using this stop mode.
3	INHIBIT_ OPERATION	1	Proceed to OPERATION ENABLED . Note: Run enable signal must be active; see the drive documentation. If the drive is set to receive the Run enable signal from the fieldbus, this bit activates the signal.
		0	Inhibit operation. Proceed to OPERATION INHIBITED .
4	RAMP_OUT_ ZERO	1	Normal operation. Proceed to RAMP FUNCTION GENERATOR: OUTPUT ENABLED .
		0	Force Ramp Function Generator output to zero. Drive ramps to stop (current and DC voltage limits in force).
5	RAMP_HOLD	1	Enable ramp function. Proceed to RAMP FUNCTION GENERATOR: ACCELERATOR ENABLED .
		0	Halt ramping (Ramp Function Generator output held).
6	RAMP_IN_ ZERO	1	Normal operation. Proceed to OPERATING . Note: This bit is effective only if the fieldbus interface is set as the source for this signal by drive parameters.
		0	Force Ramp Function Generator input to zero.

Bit	Name	Value	STATE/Description
7	RESET	0=>1	Fault reset if an active fault exists. Proceed to SWITCH-ON INHIBITED . Note: This bit is effective only if the fieldbus interface is set as the source for this signal by drive parameters.
		0	Continue normal operation.
8	JOGGING_1	1	Accelerate to jogging 1 reference. Notes: • Bits 4...6 must be 0. • See also section <i>Jogging</i> (page 57).
		0	Jogging 1 disabled.
9	JOGGING_2	1	Accelerate to jogging 2 reference. See notes at bit 8.
		0	Jogging 2 disabled.
10	REMOTE_CMD	1	Fieldbus control enabled.
		0	Control Word <> 0 or Reference <> 0: Retain last Control Word and Reference. Control Word = 0 and Reference = 0: Fieldbus control enabled. Reference and deceleration/acceleration ramp are locked.
11	EXT_CTRL_LOC	1	Select External Control Location EXT2. Effective if the control location is parameterized to be selected from the fieldbus.
		0	Select External Control Location EXT1. Effective if the control location is parameterized to be selected from the fieldbus.
12...15	Reserved		

■ Status Word

The table below shows the fieldbus Status Word for the ABB Drives control profile. The embedded fieldbus interface converts the drive Status Word into this form for the fieldbus. The upper case boldface text refers to the states shown in [State transition diagram](#) on page 540.

Bit	Name	Value	STATE/Description
0	RDY_ON	1	READY TO SWITCH ON.
		0	NOT READY TO SWITCH ON.
1	RDY_RUN	1	READY TO OPERATE.
		0	OFF1 ACTIVE.
2	RDY_REF	1	OPERATION ENABLED.
		0	OPERATION INHIBITED.
3	TRIPPED	1	FAULT.
		0	No fault.
4	OFF_2_STA	1	OFF2 inactive.
		0	OFF2 ACTIVE.
5	OFF_3_STA	1	OFF3 inactive.
		0	OFF3 ACTIVE.
6	SWC_ON_INHIB	1	SWITCH-ON INHIBITED.
		0	–
7	ALARM	1	Warning/Alarm.
		0	No warning/alarm.
8	AT_SETPOINT	1	OPERATING. Actual value equals Reference = is within tolerance limits, i.e. in speed control, speed error is 10% max. of nominal motor speed.
		0	Actual value differs from Reference = is outside tolerance limits.
9	REMOTE	1	Drive control location: REMOTE (EXT1 or EXT2).
		0	Drive control location: LOCAL.
10	ABOVE_LIMIT	1	Actual frequency or speed equals or exceeds supervision limit (set by drive parameter). Valid in both directions of rotation.
		0	Actual frequency or speed within supervision limit.
11	USER_0		S
12	EXT_RUN_ENABLE	1	External Run enable signal received.
		0	No external Run enable signal received.
13...15	Reserved		

State transition diagram

The diagram below shows the state transitions in the drive when the drive is using the ABB Drives profile, and configured to follow the commands of the control word from the embedded fieldbus interface. The upper case texts refer to the states which are used in the tables representing the fieldbus Control and Status words. See sections [Control Word](#) on page 537 and [Status Word](#) on page 539.

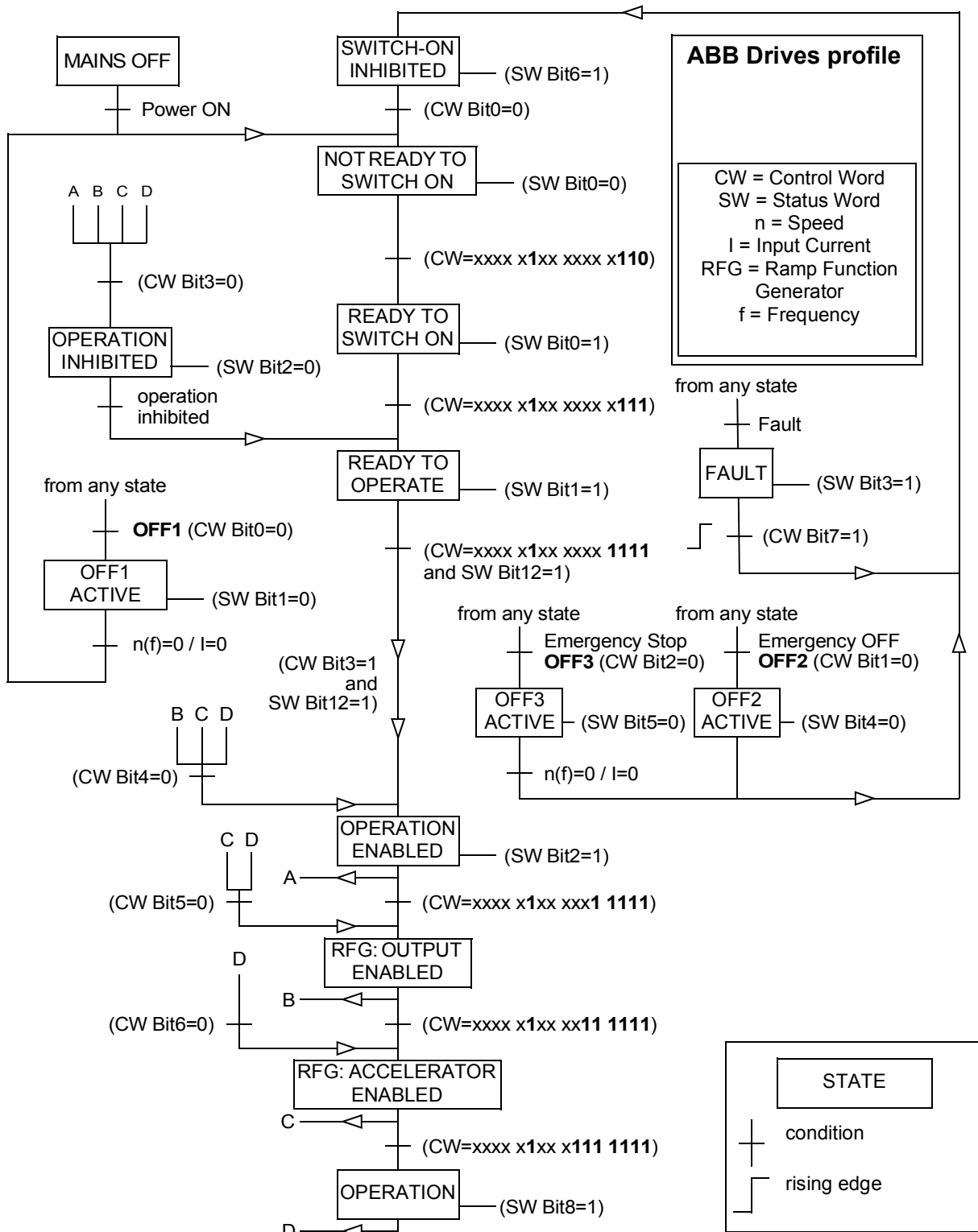

References

The ABB drives profile supports the use of two references, EFB reference 1 and EFB reference 2. The references are 16-bit words each containing a sign bit and a 15-bit integer. A negative reference is formed by calculating the two's complement from the corresponding positive reference.

The references are scaled as defined by parameters [46.01...46.07](#); which scaling is in use depends on the setting of [58.26 EFB ref1 type](#) and [58.27 EFB ref2 type](#) (see page [351](#)).

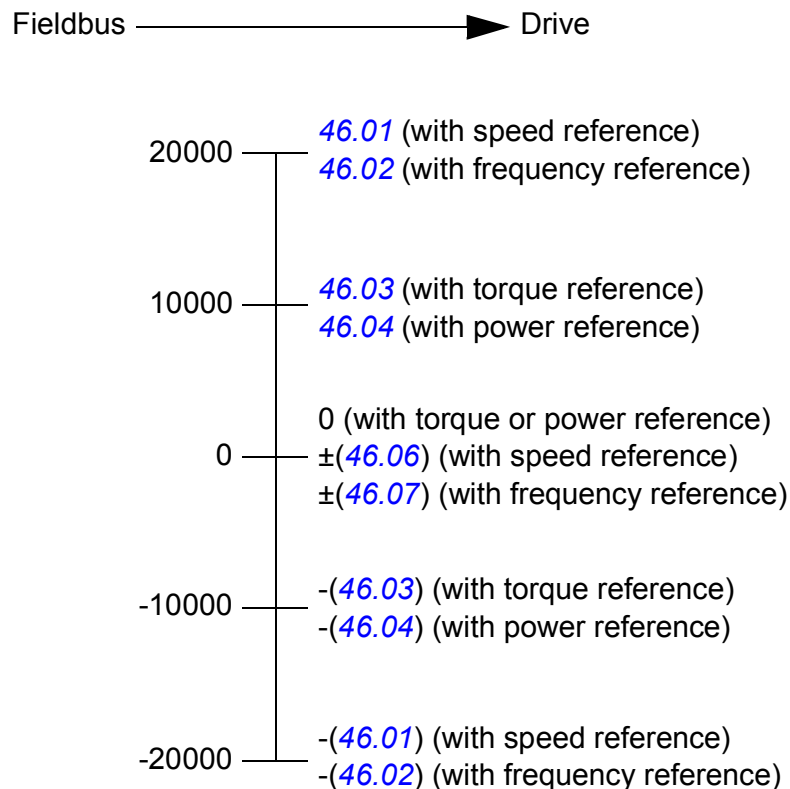

The scaled references are shown by parameters [03.09 EFB reference 1](#) and [03.10 EFB reference 2](#).

Actual values

The ABB Drives profile supports the use of two fieldbus actual values, ACT1 and ACT2. The actual values are 16-bit words each containing a sign bit and a 15-bit integer. A negative value is formed by calculating the two's complement from the corresponding positive value.

The actual values are scaled as defined by parameters [46.01...46.04](#); which scaling is in use depends on the setting of parameters [58.28 EFB act1 type](#) and [58.29 EFB act2 type](#) (see page [352](#)).

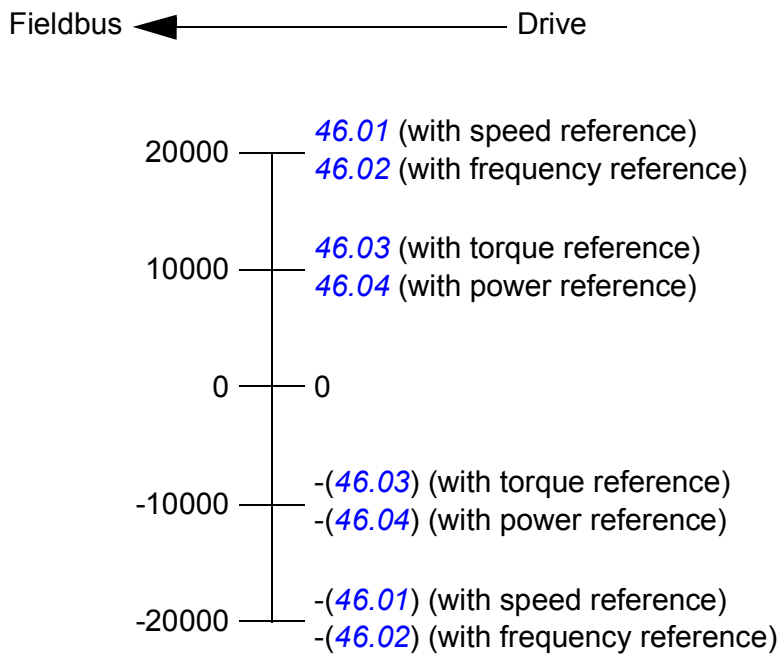

■ Modbus holding register addresses

The table below shows the default Modbus holding register addresses for drive data. This profile provides a converted 16-bit access to the data.

Register address	Register data (16-bit words)
400001	Control word. See section Control Word (page 537). The selection can be changed using parameter 58.101 Data I/O 1 .
400002	Reference 1 (REF1). The selection can be changed using parameter 58.102 Data I/O 2 .
400003	Reference 2 (REF2). The selection can be changed using parameter 58.103 Data I/O 3 .
400004	Status Word (SW). See section Status Word (page 539). The selection can be changed using parameter 58.104 Data I/O 4 .
400005	Actual value 1 (ACT1). The selection can be changed using parameter 58.105 Data I/O 5 .
400006	Actual value 2 (ACT2). The selection can be changed using parameter 58.106 Data I/O 6 .
400007...400024	Data in/out 7...24. Selected by parameters 58.107 Data I/O 7 ... 58.124 Data I/O 24 .
400025...400089	Unused
400090...400100	Error code access. See section Error code registers (holding registers 400090...400100) (page 550).
400101...465536	Parameter read/write. Parameters are mapped to register addresses according to parameter 58.33 Addressing mode .

The Transparent profile

The Transparent profile enables a customizable access to the drive.

The contents of the control word are user-definable. The control word received from the fieldbus is visible in parameter [06.05 EFB transparent control word](#), and can be used to control the drive using pointer parameters and/or application programming.

The status word to be sent to the fieldbus controller is selected by parameter [58.30 EFB status word transparent source](#). This can be, for example, the user-configurable status word in [06.50 User status word 1](#).

The Transparent profile involves no data conversion of the control or status word. Whether references or actual values are scaled depends on the setting of parameters [58.26...58.29](#). The references received from the fieldbus are visible in parameters [03.09 EFB reference 1](#) and [03.10 EFB reference 2](#).

The Modbus holding register addresses for the Transparent profile are as with the ABB Drives profile (see page [543](#)).

Modbus function codes

The table below shows the Modbus function codes supported by the embedded fieldbus interface.

Code	Function name	Description
01h	Read Coils	Reads the 0/1 status of coils (0X references).
02h	Read Discrete Inputs	Reads the 0/1 status of discrete inputs (1X references).
03h	Read Holding Registers	Reads the binary contents of holding registers (4X references).
05h	Write Single Coil	Forces a single coil (0X reference) to 0 or 1.
06h	Write Single Register	Writes a single holding register (4X reference).
08h	Diagnostics	Provides a series of tests for checking the communication, or for checking various internal error conditions. Supported subcodes: <ul style="list-style-type: none"> • 00h Return Query Data: Echo/loopback test. • 01h Restart Comm Option: Restarts and initializes the EFB, clears communications event counters. • 04h Force Listen Only Mode • 0Ah Clear Counters and Diagnostic Register • 0Bh Return Bus Message Count • 0Ch Return Bus Comm. Error Count • 0Dh Return Bus Exception Error Count • 0Eh Return Slave Message Count • 0Fh Return Slave No Response Count • 10h Return Slave NAK (negative acknowledge) Count • 11h Return Slave Busy Count • 12h Return Bus Character Overrun Count • 14h Clear Overrun Counter and Flag
0Bh	Get Comm Event Counter	Returns a status word and an event count.
0Fh	Write Multiple Coils	Forces a sequence of coils (0X references) to 0 or 1.
10h	Write Multiple Registers	Writes the contents of a contiguous block of holding registers (4X references).
16h	Mask Write Register	Modifies the contents of a 4X register using a combination of an AND mask, an OR mask, and the register's current contents.
17h	Read/Write Multiple Registers	Writes the contents of a contiguous block of 4X registers, then reads the contents of another group of registers (the same or different than those written) in a server device.

Code	Function name	Description
2Bh / 0Eh	Encapsulated Interface Transport	<p>Supported subcodes:</p> <ul style="list-style-type: none"> • 0Eh Read Device Identification: Allows reading the identification and other information. <p>Supported ID codes (access type):</p> <ul style="list-style-type: none"> • 00h: Request to get the basic device identification (stream access) • 04h: Request to get one specific identification object (individual access) <p>Supported Object IDs:</p> <ul style="list-style-type: none"> • 00h: Vendor Name (“ABB”) • 01h: Product Code (for example, “AINFX”) • 02h: Major Minor Revision (combination of contents of parameters 07.05 Firmware version and 58.02 Protocol ID). • 03h: Vendor URL (“www.abb.com”) • 04h: Product name (for example, “ACS780”)

Exception codes

The table below shows the Modbus exception codes supported by the embedded fieldbus interface.

Code	Name	Description
01h	ILLEGAL FUNCTION	The function code received in the query is not an allowable action for the server.
02h	ILLEGAL DATA ADDRESS	The data address received in the query is not an allowable address for the server.
03h	ILLEGAL DATA VALUE	The requested Quantity of Registers is larger than the drive can handle. Note: This error does not mean that a value written to a drive parameter is outside the valid range.
04h	SLAVE DEVICE FAILURE	The value written to a drive parameter is outside the valid range. See section Error code registers (holding registers 400090...400100) on page 550.
06h	SLAVE DEVICE BUSY	The server is engaged in processing a long-duration program command.

Coils (0xxxx reference set)

Coils are 1-bit read/write values. Control Word bits are exposed with this data type. The table below summarizes the Modbus coils (0xxxx reference set).

Reference	ABB drives profile	Transparent profile
00001	OFF1_CONTROL	Control Word bit 0
00002	OFF2_CONTROL	Control Word bit 1
00003	OFF3_CONTROL	Control Word bit 2
00004	INHIBIT_OPERATION	Control Word bit 3
00005	RAMP_OUT_ZERO	Control Word bit 4
00006	RAMP_HOLD	Control Word bit 5
00007	RAMP_IN_ZERO	Control Word bit 6
00008	RESET	Control Word bit 7
00009	JOGGING_1	Control Word bit 8
00010	JOGGING_2	Control Word bit 9
00011	REMOTE_CMD	Control Word bit 10
00012	EXT_CTRL_LOC	Control Word bit 11
00013	User-defined (0)	Control Word bit 12
00014	User-defined (1)	Control Word bit 13
00015	User-defined (2)	Control Word bit 14
00016	User-defined (3)	Control Word bit 15
00017	Reserved	Control Word bit 16
00018	Reserved	Control Word bit 17
00019	Reserved	Control Word bit 18
00020	Reserved	Control Word bit 19
00021	Reserved	Control Word bit 20
00022	Reserved	Control Word bit 21
00023	Reserved	Control Word bit 22
00024	Reserved	Control Word bit 23
00025	Reserved	Control Word bit 24
00026	Reserved	Control Word bit 25
00027	Reserved	Control Word bit 26
00028	Reserved	Control Word bit 27
00029	Reserved	Control Word bit 28
00030	Reserved	Control Word bit 29
00031	Reserved	Control Word bit 30
00032	Reserved	Control Word bit 31
00033	Reserved	<i>10.99 RO/DIO control word</i> , bit 0
00034	Reserved	<i>10.99 RO/DIO control word</i> , bit 1

Reference	ABB drives profile	Transparent profile
00035	Reserved	<i>10.99 RO/DIO control word</i> , bit 2
00036	Reserved	<i>10.99 RO/DIO control word</i> , bit 3
00037	Reserved	<i>10.99 RO/DIO control word</i> , bit 4
00038	Reserved	<i>10.99 RO/DIO control word</i> , bit 5
00039	Reserved	<i>10.99 RO/DIO control word</i> , bit 6
00040	Reserved	<i>10.99 RO/DIO control word</i> , bit 7
00041	Reserved	<i>10.99 RO/DIO control word</i> , bit 8
00042	Reserved	<i>10.99 RO/DIO control word</i> , bit 9

Discrete inputs (1xxxx reference set)

Discrete inputs are 1-bit read-only values. Status Word bits are exposed with this data type. The table below summarizes the Modbus discrete inputs (1xxxx reference set).

Reference	ABB drives profile	Transparent profile
10001	RDY_ON	Status Word bit 0
10002	RDY_RUN	Status Word bit 1
10003	RDY_REF	Status Word bit 2
10004	TRIPPED	Status Word bit 3
10005	OFF_2_STA	Status Word bit 4
10006	OFF_3_STA	Status Word bit 5
10007	SWC_ON_INHIB	Status Word bit 6
10008	ALARM	Status Word bit 7
10009	AT_SETPOINT	Status Word bit 8
10010	REMOTE	Status Word bit 9
10011	ABOVE_LIMIT	Status Word bit 10
10012	User-defined (0)	Status Word bit 11
10013	User-defined (1)	Status Word bit 12
10014	User-defined (2)	Status Word bit 13
10015	User-defined (3)	Status Word bit 14
10016	Reserved	Status Word bit 15
10017	Reserved	Status Word bit 16
10018	Reserved	Status Word bit 17
10019	Reserved	Status Word bit 18
10020	Reserved	Status Word bit 19
10021	Reserved	Status Word bit 20
10022	Reserved	Status Word bit 21
10023	Reserved	Status Word bit 22
10024	Reserved	Status Word bit 23

Reference	ABB drives profile	Transparent profile
10025	Reserved	Status Word bit 24
10026	Reserved	Status Word bit 25
10027	Reserved	Status Word bit 26
10028	Reserved	Status Word bit 27
10029	Reserved	Status Word bit 28
10030	Reserved	Status Word bit 29
10031	Reserved	Status Word bit 30
10032	Reserved	Status Word bit 31
10033	Reserved	<i>10.02 DI delayed status</i> , bit 0
10034	Reserved	<i>10.02 DI delayed status</i> , bit 1
10035	Reserved	<i>10.02 DI delayed status</i> , bit 2
10036	Reserved	<i>10.02 DI delayed status</i> , bit 3
10037	Reserved	<i>10.02 DI delayed status</i> , bit 4
10038	Reserved	<i>10.02 DI delayed status</i> , bit 5
10039	Reserved	<i>10.02 DI delayed status</i> , bit 6
10040	Reserved	<i>10.02 DI delayed status</i> , bit 7
10041	Reserved	<i>10.02 DI delayed status</i> , bit 8
10042	Reserved	<i>10.02 DI delayed status</i> , bit 9
10043	Reserved	<i>10.02 DI delayed status</i> , bit 10
10044	Reserved	<i>10.02 DI delayed status</i> , bit 11
10045	Reserved	<i>10.02 DI delayed status</i> , bit 12
10046	Reserved	<i>10.02 DI delayed status</i> , bit 13
10047	Reserved	<i>10.02 DI delayed status</i> , bit 14
10048	Reserved	<i>10.02 DI delayed status</i> , bit 15

Error code registers (holding registers 400090...400100)

These registers contain information about the last query. The error register is cleared when a query has finished successfully.

Reference	Name	Description
89	Reset Error Registers	1 = Reset internal error registers (91...95).
90	Error Function Code	Function code of the failed query.
91	Error Code	Set when exception code 04h is generated (see table above). <ul style="list-style-type: none"> • 00h No error • 02h Low/High limit exceeded • 03h Faulty Index: Unavailable index of an array parameter • 05h Incorrect Data Type: Value does not match the data type of the parameter • 65h General Error: Undefined error when handling query
92	Failed Register	The last register (discrete input, coil, or holding register) that failed to be read or written.
93	Last Register Written Successfully	The last register that was written successfully.
94	Last Register Read Successfully	The last register that was read successfully.



Fieldbus control through a fieldbus adapter

What this chapter contains

This chapter describes how the drive can be controlled by external devices over a communication network (fieldbus) through an optional fieldbus adapter module.

The fieldbus control interface of the drive is described first, followed by a configuration example.

System overview

The drive can be connected to an external control system through an optional fieldbus adapter mounted onto the control unit of the drive. The drive actually has two independent interfaces for fieldbus connection, called “fieldbus adapter A” (FBA A) and “fieldbus adapter B” (FBA B). The drive can be configured to receive all of its control information through the fieldbus interface(s), or the control can be distributed between the fieldbus interface(s) and other available sources such as digital and analog inputs, depending on how control locations EXT1 and EXT2 are configured.

Note: It is recommended that the FBA B interface is only used for monitoring.

Fieldbus adapters are available for various communication systems and protocols, for example

- CANopen (FCAN-01 adapter)
- ControlNet (FCNA-01 adapter)
- DeviceNet (FDNA-01 adapter)
- EtherCAT® (FECA-01 adapter)
- EtherNet/IP™ (FENA-11 or FENA-21 adapter)
- Modbus/RTU (FSCA-01 adapter)
- Modbus/TCP (FENA-11 or FENA-21 adapter)
- POWERLINK (FEPL-02 adapter)
- PROFIBUS DP (FPBA-01 adapter)
- PROFINET IO (FENA-11 or FENA-21 adapter).

The following M-Series modules or USB is supported:

- PROFIBUS DP (FPBA-01-M adapter)
- CANopen (FCAN-01-M adapter)
- EtherNet/IP™ (FENA-21-M adapter)
- EtherCAT® (FECA-01-M adapter)

Note: The text and examples in this chapter describe the configuration of one fieldbus adapter (FBA A) by parameters [50.01](#)...[50.21](#) and parameter groups 51...53. The second adapter (FBA B), if present, is configured in a similar fashion by parameters [50.31](#)...[50.51](#) and parameter groups 54...56.

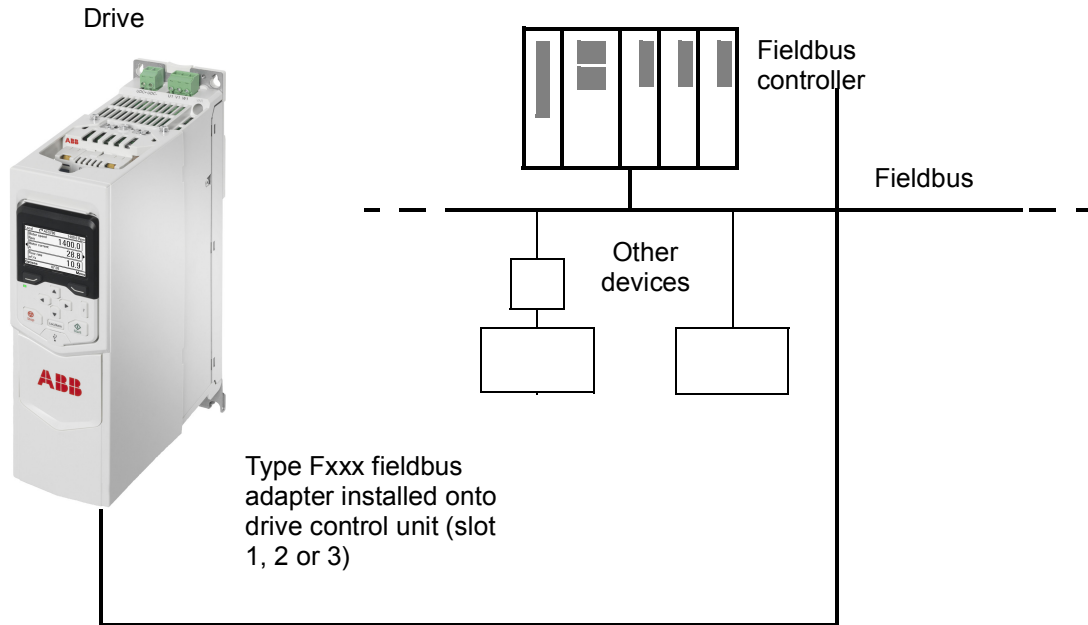

Data Flow

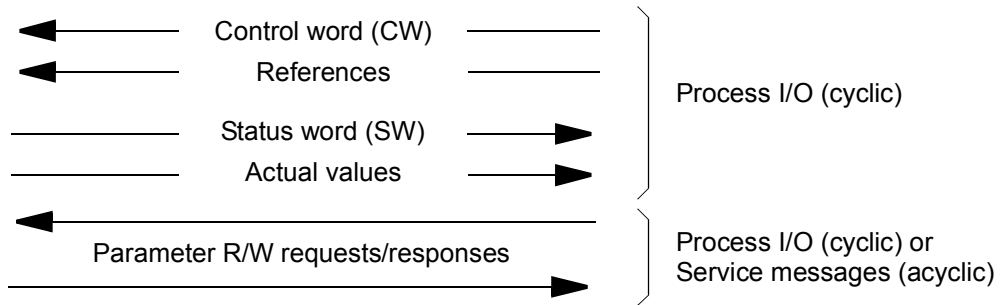

Basics of the fieldbus control interface

The cyclic communication between a fieldbus system and the drive consists of 16- or 32-bit input and output data words. The drive is able to support a maximum of 12 data words (16 bits) in each direction.

Data transmitted from the drive to the fieldbus controller is defined by parameters [52.01 FBA A data in1](#) ... [52.12 FBA A data in12](#). The data transmitted from the fieldbus controller to the drive is defined by parameters [53.01 FBA A data out1](#) ... [53.12 FBA A data out12](#).

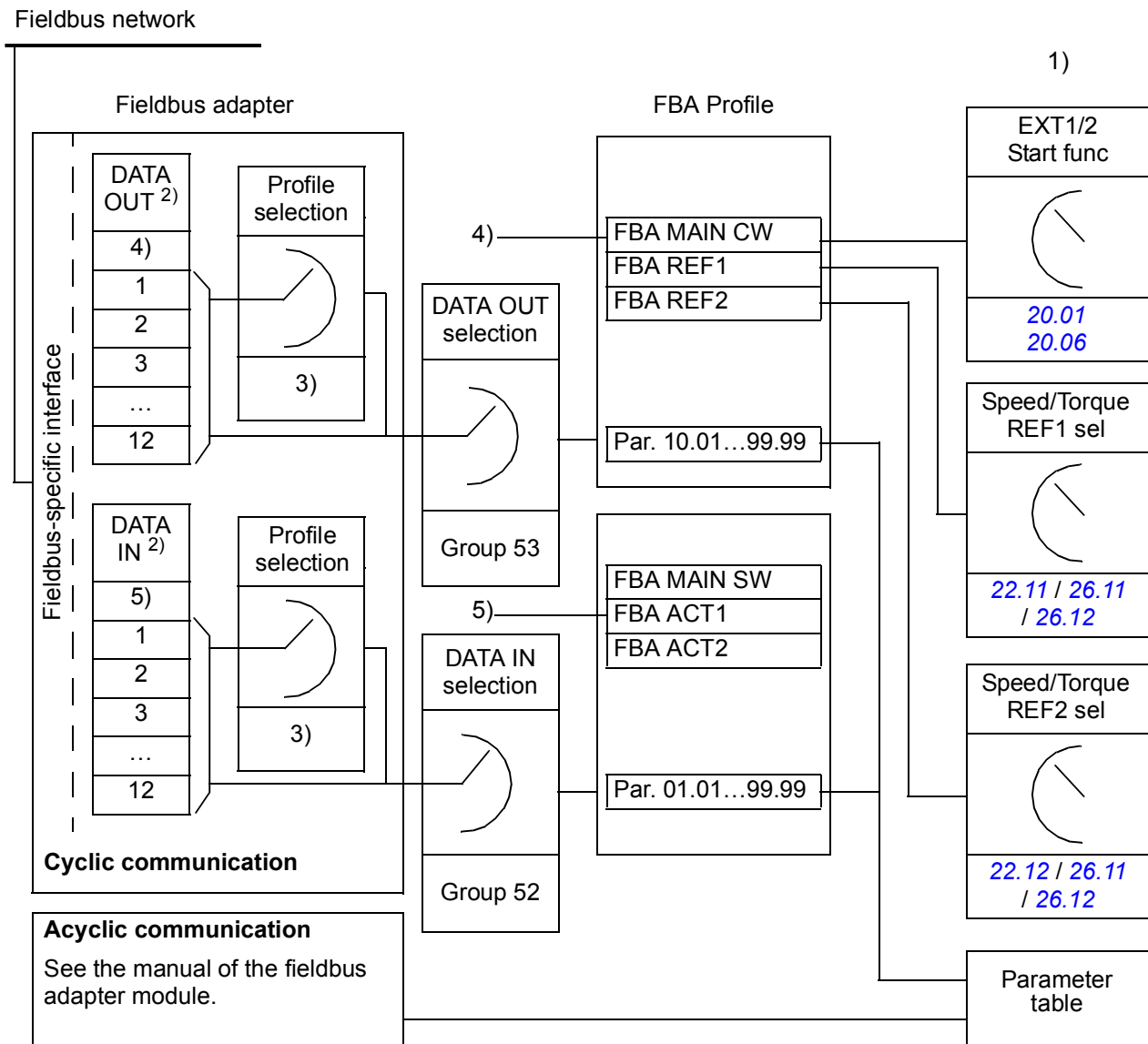

- 1) See also other parameters which can be controlled from fieldbus.
- 2) The maximum number of data words used is protocol-dependent.
- 3) Profile/instance selection parameters. Fieldbus module specific parameters. For more information, see the *User's Manual* of the appropriate fieldbus adapter module.
- 4) With DeviceNet, the control part is transmitted directly.
- 5) With DeviceNet, the actual value part is transmitted directly.

■ Control word and Status word

The Control word is the principal means for controlling the drive from a fieldbus system. It is sent by the fieldbus master station to the drive through the adapter module. The drive switches between its states according to the bit-coded instructions in the Control word, and returns status information to the master in the Status word.

The contents of the Control word and the Status word are detailed on pages [558](#) and [559](#) respectively. The drive states are presented in the state diagram (page [560](#)).

Debugging the network words

If parameter [50.12 FBA A debug mode](#) is set to *Fast*, the Control word received from the fieldbus is shown by parameter [50.13 FBA A control word](#), and the Status word transmitted to the fieldbus network by [50.16 FBA A status word](#). This “raw” data is very useful to determine if the fieldbus master is transmitting the correct data before handing control to the fieldbus network.

References

References are 16-bit words containing a sign bit and a 15-bit integer. A negative reference (indicating reversed direction of rotation) is formed by calculating the two's complement from the corresponding positive reference.

ABB drives can receive control information from multiple sources including analog and digital inputs, the drive control panel and a fieldbus adapter module. In order to have the drive controlled through the fieldbus, the module must be defined as the source for control information such as reference. This is done using the source selection parameters in groups [22 Speed reference selection](#), [26 Torque reference chain](#) and [28 Frequency reference chain](#).

Debugging the network words

If parameter [50.12 FBA A debug mode](#) is set to *Fast*, the references received from the fieldbus are displayed by [50.14 FBA A reference 1](#) and [50.15 FBA A reference 2](#).

Scaling of references

The references are scaled as defined by parameters [46.01...46.07](#); which scaling is in use depends on the setting of [50.04 FBA A ref1 type](#) and [50.05 FBA A ref2 type](#).

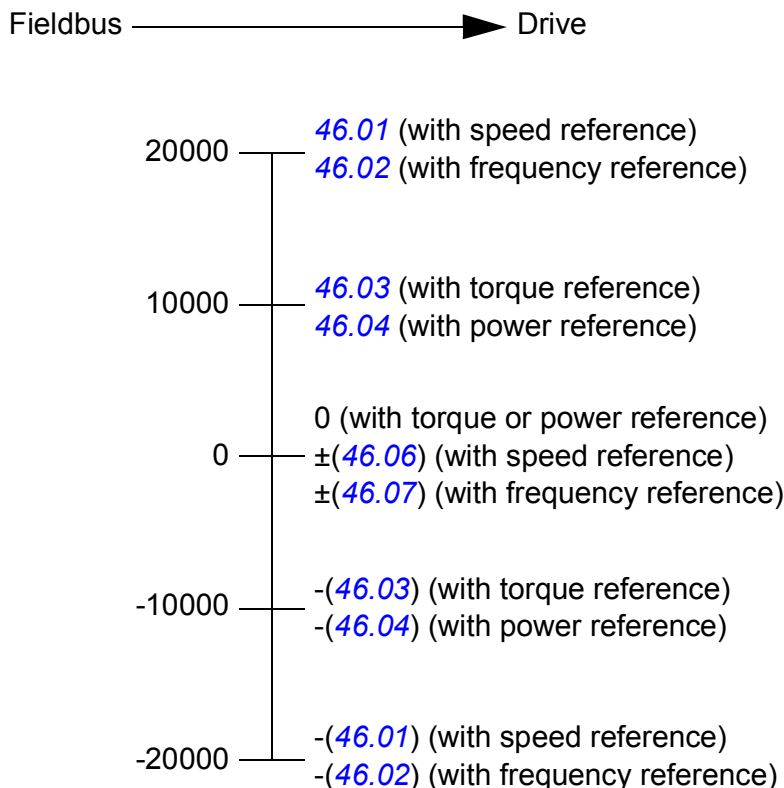

The scaled references are shown by parameters [03.05 FB A reference 1](#) and [03.06 FB A reference 2](#).

Actual values

Actual values are 16-bit words containing information on the operation of the drive. The types of the monitored signals are selected by parameters [50.07 FBA A actual 1 type](#) and [50.08 FBA A actual 2 type](#).

Debugging the network words

If parameter [50.12 FBA A debug mode](#) is set to *Fast*, the actual values sent to the fieldbus are displayed by [50.17 FBA A actual value 1](#) and [50.18 FBA A actual value 2](#).

Scaling of actual values

The actual values are scaled as defined by parameters [46.01...46.04](#); which scaling is in use depends on the setting of parameters [50.07 FBA A actual 1 type](#) and [50.08 FBA A actual 2 type](#).

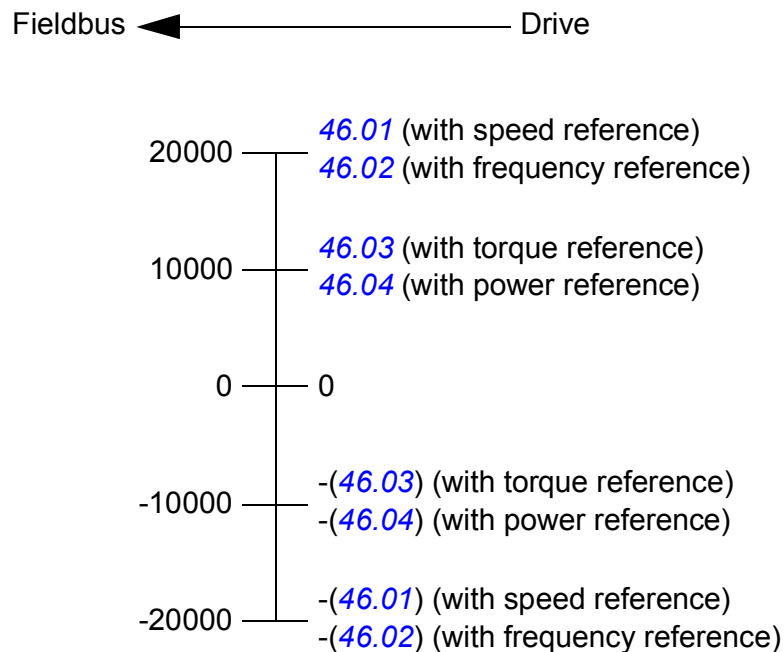

■ Contents of the fieldbus Control word

The upper case boldface text refers to the states shown in the state diagram (page 560).

Bit	Name	Value	STATE/Description
0	Off1 control	1	Proceed to READY TO OPERATE .
		0	Stop along currently active deceleration ramp. Proceed to OFF1 ACTIVE ; proceed to READY TO SWITCH ON unless other interlocks (OFF2, OFF3) are active.
1	Off2 control	1	Continue operation (OFF2 inactive).
		0	Emergency OFF, coast to a stop. Proceed to OFF2 ACTIVE , proceed to SWITCH-ON INHIBITED .
2	Off3 control	1	Continue operation (OFF3 inactive).
		0	Emergency stop, stop within time defined by drive parameter. Proceed to OFF3 ACTIVE ; proceed to SWITCH-ON INHIBITED .  WARNING: Ensure motor and driven machine can be stopped using this stop mode.
3	Run	1	Proceed to OPERATION ENABLED . Note: Run enable signal must be active. If the drive is set to receive the Run enable signal from the fieldbus, this bit activates the signal.
		0	Inhibit operation. Proceed to OPERATION INHIBITED .
4	Ramp out zero	1	Normal operation. Proceed to RAMP FUNCTION GENERATOR: OUTPUT ENABLED .
		0	Force Ramp function generator output to zero. The drive will immediately decelerate to zero speed (observing the torque limits).
5	Ramp hold	1	Enable ramp function. Proceed to RAMP FUNCTION GENERATOR: ACCELERATOR ENABLED .
		0	Halt ramping (Ramp Function Generator output held).
6	Ramp in zero	1	Normal operation. Proceed to OPERATING . Note: This bit is effective only if the fieldbus interface is set as the source for this signal by drive parameters.
		0	Force Ramp function generator input to zero.
7	Reset	0=>1	Fault reset if an active fault exists. Proceed to SWITCH-ON INHIBITED . Note: This bit is effective only if the fieldbus interface is set as the source of the reset signal by drive parameters.
		0	Continue normal operation.
8	Inching 1	1	Accelerate to inching (jogging) setpoint 1. Notes: • Bits 4...6 must be 0. • See also section <i>Jogging</i> (page 57).
		0	Inching (jogging) 1 disabled.
9	Inching 2	1	Accelerate to inching (jogging) setpoint 2. See notes at bit 8.
		0	Inching (jogging) 2 disabled.
10	Remote cmd	1	Fieldbus control enabled.
		0	Control word and reference not getting through to the drive, except for bits 0...2.
11	Ext ctrl loc	1	Select External Control Location EXT2. Effective if control location is parameterized to be selected from fieldbus.
		0	Select External Control Location EXT1. Effective if control location is parameterized to be selected from fieldbus.
12 to 15	Reserved.		

■ Contents of the fieldbus Status word

The upper case boldface text refers to the states shown in the state diagram (page 560).

Bit	Name	Value	STATE/Description
0	Ready to switch ON	1	READY TO SWITCH ON.
		0	NOT READY TO SWITCH ON.
1	Ready run	1	READY TO OPERATE.
		0	OFF1 ACTIVE.
2	Ready ref	1	OPERATION ENABLED.
		0	OPERATION INHIBITED.
3	Tripped	1	FAULT.
		0	No fault.
4	Off 2 inactive	1	OFF2 inactive.
		0	OFF2 ACTIVE.
5	Off 3 inactive	1	OFF3 inactive.
		0	OFF3 ACTIVE.
6	Switch-on inhibited	1	SWITCH-ON INHIBITED.
		0	–
7	Warning	1	Warning active.
		0	No warning active.
8	Reserved		
9	Remote	1	Drive control location: REMOTE (EXT1 or EXT2).
		0	Drive control location: LOCAL.
10	Above limit	-	See parameter 06.29 MSW bit 10 sel.
11	User bit 0	-	See parameter 06.30 MSW bit 11 sel.
12	User bit 1	-	See parameter 06.31 MSW bit 12 sel.
13	User bit 2	-	See parameter 06.32 MSW bit 13 sel.
14	User bit 3	-	See parameter 06.33 MSW bit 14 sel.
15	Reserved		

■ The state diagram

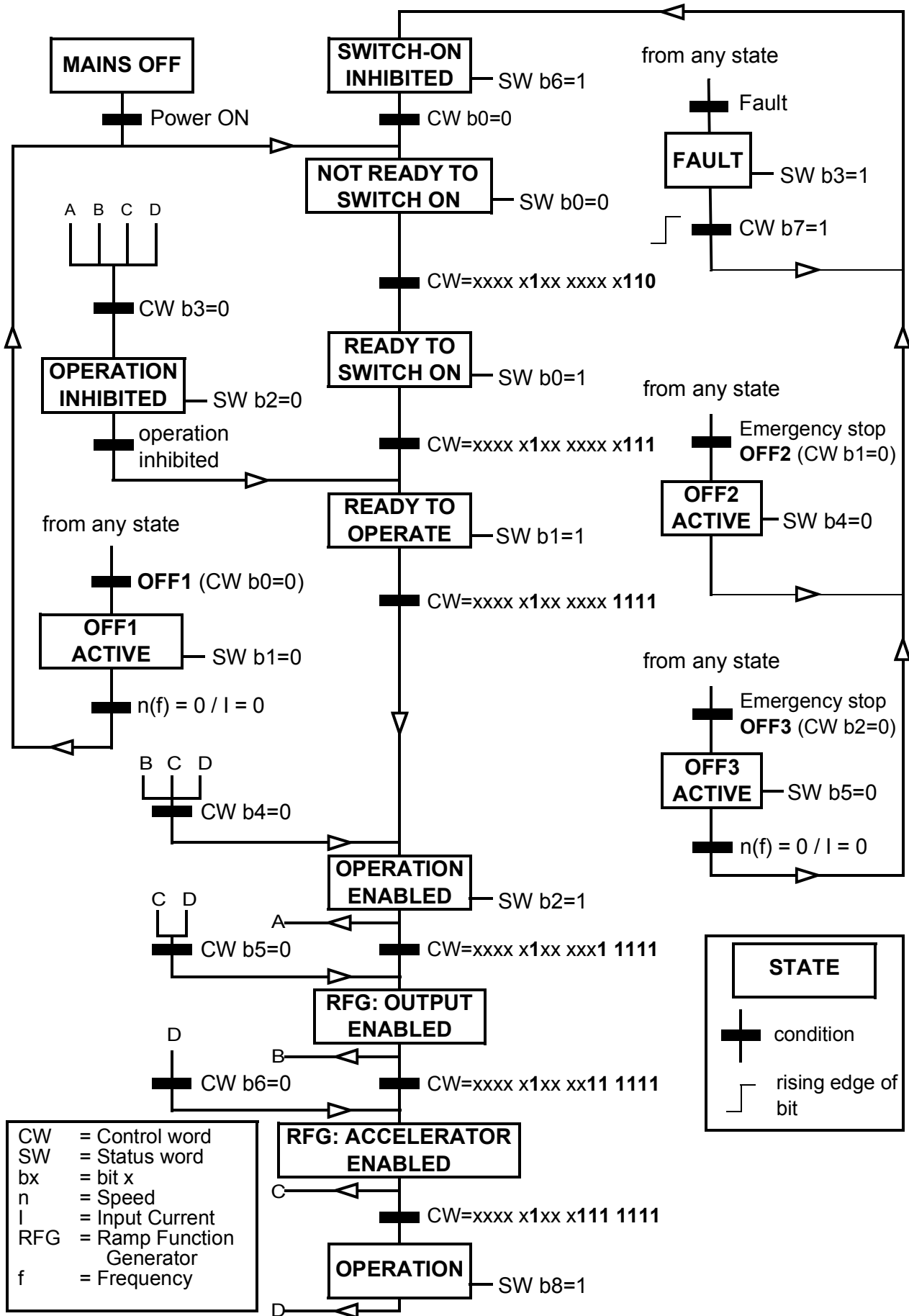

Setting up the drive for fieldbus control

1. Install the fieldbus adapter module mechanically and electrically according to the instructions given in the *User's manual* of the module.
 2. Power up the drive.
 3. Enable the communication between the drive and the fieldbus adapter module with parameter [50.01 FBA A enable](#).
 4. With [50.02 FBA A comm loss func](#), select how the drive should react to a fieldbus communication break.
Note: This function monitors both the communication between the fieldbus master and the adapter module and the communication between the adapter module and the drive.
 5. With [50.03 FBA A comm loss t out](#), define the time between communication break detection and the selected action.
 6. Select application-specific values for the rest of the parameters in group [50 Fieldbus adapter \(FBA\)](#), starting from [50.04](#). Examples of appropriate values are shown in the tables below.
 7. Set the fieldbus adapter module configuration parameters in group [51 FBA A settings](#). As a minimum, set the required node address and the control profile.
 8. Define the process data transferred to and from the drive in parameter groups [52 FBA A data in](#) and [53 FBA A data out](#).
Note: Depending on the communication protocol and profile being used, the Control word and Status word may already be configured to be sent/received by the communication system.
 9. Save the valid parameter values to permanent memory by setting parameter [96.07 Parameter save manually](#) to [Save](#).
 10. Validate the settings made in parameter groups 51, 52 and 53 by setting parameter [51.27 FBA A par refresh](#) to [Refresh](#).
 11. Configure control locations EXT1 and EXT2 to allow control and reference signals to come from the fieldbus. Examples of appropriate values are shown in the tables below.
-

Parameter setting example: FPBA (PROFIBUS DP)

This example shows how to configure a basic speed control application that uses the PROFIdrive communication profile with PPO Type 2. The start/stop commands and reference are according to the PROFIdrive profile, speed control mode.

The reference values sent over the fieldbus have to be scaled within the drive so they have the desired effect. The reference value ± 16384 (4000h) corresponds to the range of speed set in parameter [46.01 Speed scaling](#) (both forward and reverse directions). For example, if [46.01](#) is set to 480 rpm, then 4000h sent over fieldbus will request 480 rpm.

Direction	PZD1	PZD2	PZD3	PZD4	PZD5	PZD6
Out	Control word	Speed reference	Acc time 1		Dec time 1	
In	Status word	Speed actual value	Motor current		DC voltage	

The table below gives the recommended drive parameter settings.

Drive parameter	Setting for ACS880-M04 drives	Description
50.01 FBA A enable	1...3 = [slot number]	Enables communication between the drive and the fieldbus adapter module.
50.04 FBA A ref1 type	4 = <i>Speed</i>	Selects the fieldbus A reference 1 type and scaling.
50.07 FBA A actual 1 type	0 = <i>Speed or frequency</i>	Selects the actual value type/source and scaling according to the currently active control mode (as displayed by parameter 19.01).
51.01 FBA A type	1 = FPBA ¹⁾	Displays the type of the fieldbus adapter module.
51.02 Node address	3 ²⁾	Defines the PROFIBUS node address of the fieldbus adapter module.
51.03 Baud rate	12000 ¹⁾	Displays the current baud rate on the PROFIBUS network in kbit/s.
51.04 MSG type	1 = PPO1 ¹⁾	Displays the telegram type selected by the PLC configuration tool.
51.05 Profile	0 = PROFIdrive	Selects the Control word according to the PROFIdrive profile (speed control mode).
51.07 RPBA mode	0 = Disabled	Disables the RPBA emulation mode.
52.01 FBA data in1	4 = SW 16bit ¹⁾	Status word
52.02 FBA data in2	5 = Act1 16bit	Actual value 1
52.03 FBA data in3	01.07 ²⁾	Motor current
52.05 FBA data in5	01.11 ²⁾	DC voltage
53.01 FBA data out1	1 = CW 16bit ¹⁾	Control word
53.02 FBA data out2	2 = Ref1 16bit	Reference 1 (speed)

Drive parameter	Setting for ACS880-M04 drives	Description
53.03 FBA data out3	23.12 ²⁾	Acceleration time 1
53.05 FBA data out5	23.13 ²⁾	Deceleration time 1
<i>51.27 FBA A par refresh</i>	1 = <i>Refresh</i>	Validates the configuration parameter settings.
<i>19.12 Ext1 control mode</i>	2 = <i>Speed</i>	Selects speed control as the control mode 1 for external control location EXT1.
<i>20.01 Ext1 commands</i>	12 = <i>Fieldbus A</i>	Selects fieldbus adapter A as the source of the start and stop commands for external control location EXT1.
<i>20.02 Ext1 start trigger type</i>	1 = <i>Level</i>	Selects a level-triggered start signal for external control location EXT1.
<i>22.11 Speed ref1 source</i>	4 = <i>FB A ref1</i>	Selects fieldbus A reference 1 as the source for speed reference 1.

¹⁾ Read-only or automatically detected/set

²⁾ Example

The start sequence for the parameter example above is given below.

Control word:

- 477h (1143 decimal) → READY TO SWITCH ON
- 47Fh (1151 decimal) → OPERATING (Speed mode)



Control chain diagrams

What this chapter contains

The chapter presents the reference chains of the drive. The control chain diagrams can be used to trace how parameters interact and where parameters have an effect within the drive parameter system.

For a more general diagram, see section [Operating modes of the drive](#) (page 28).

Speed reference source selection I

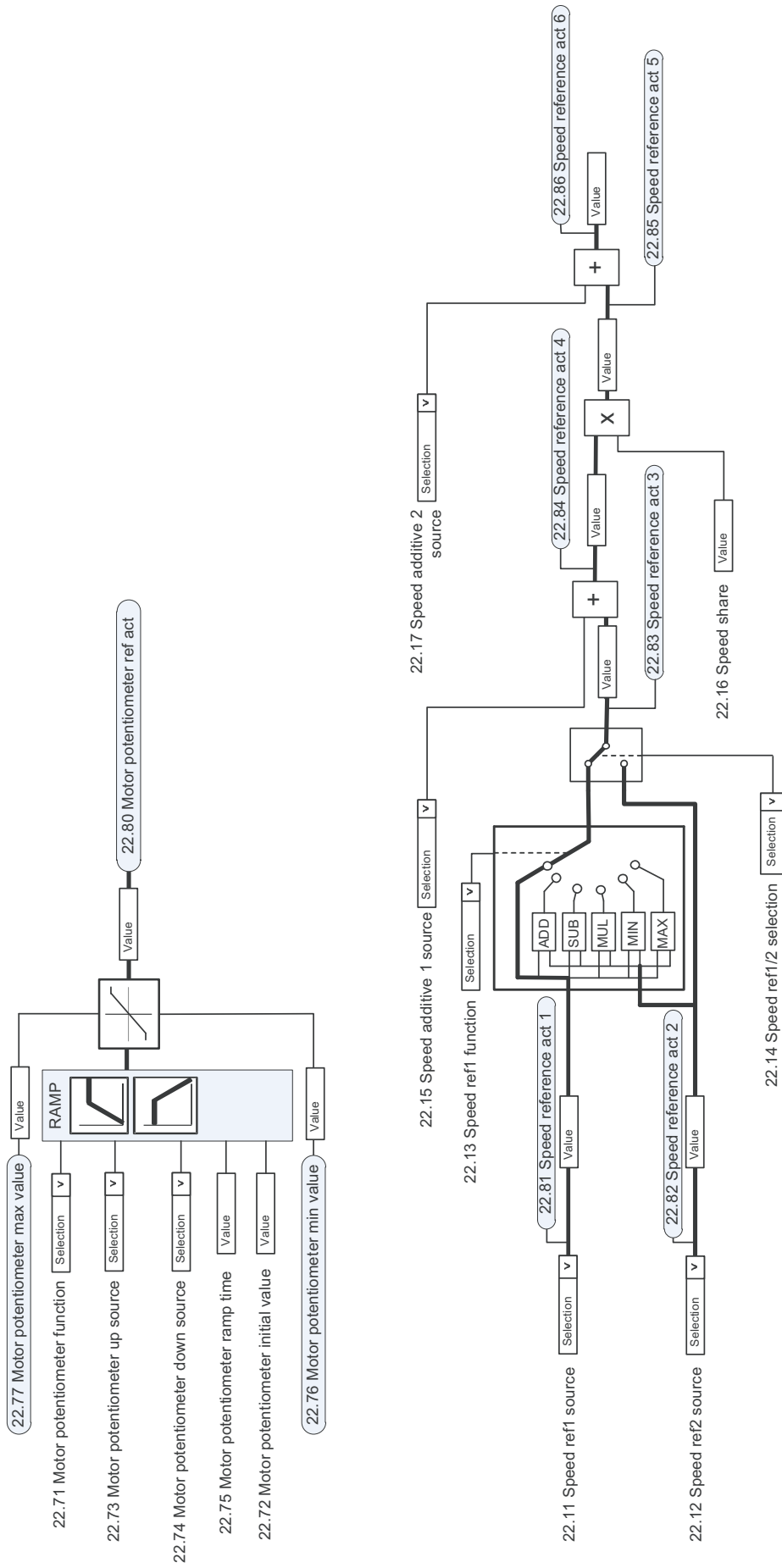

Speed reference source selection II

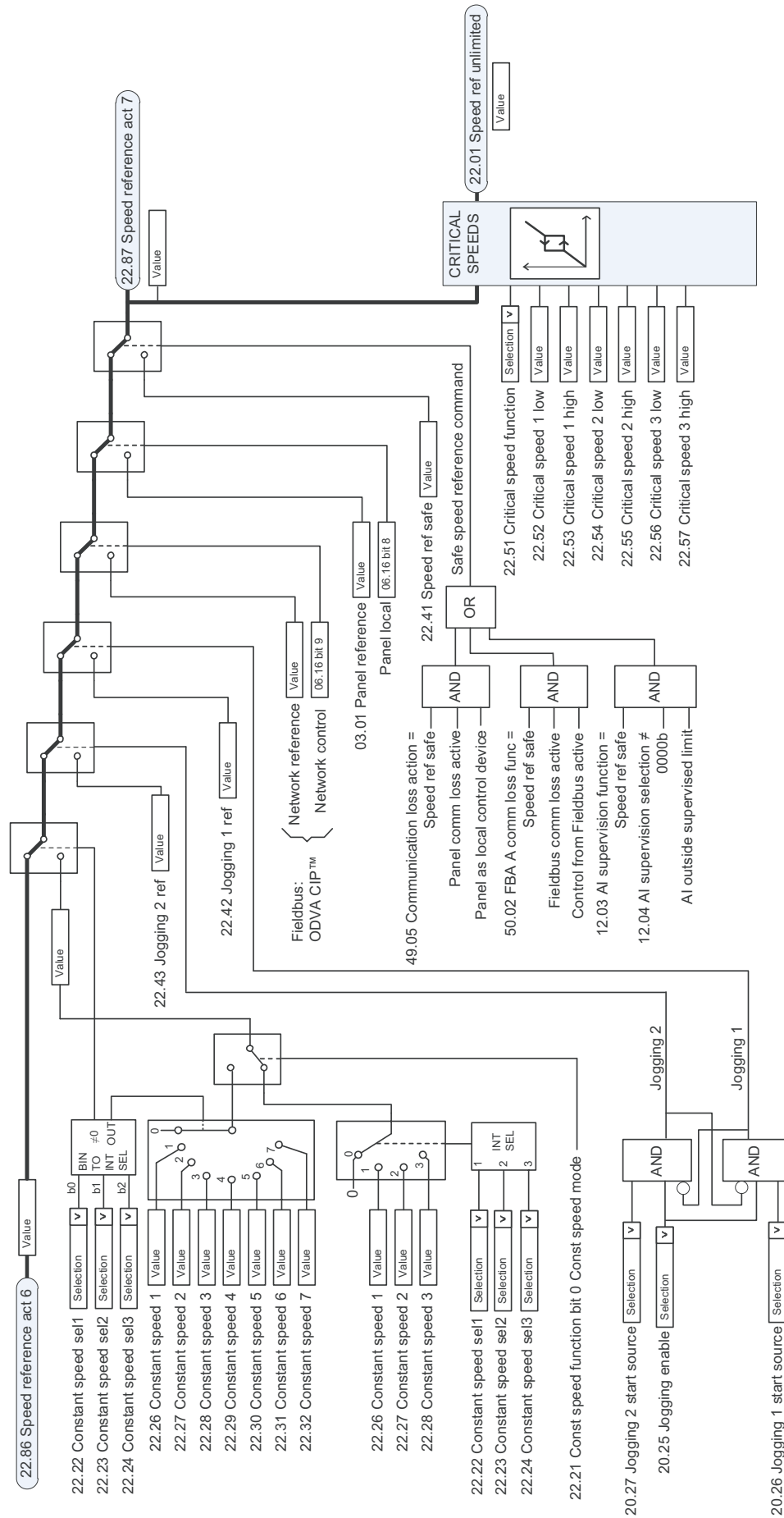

Speed reference ramping and shaping

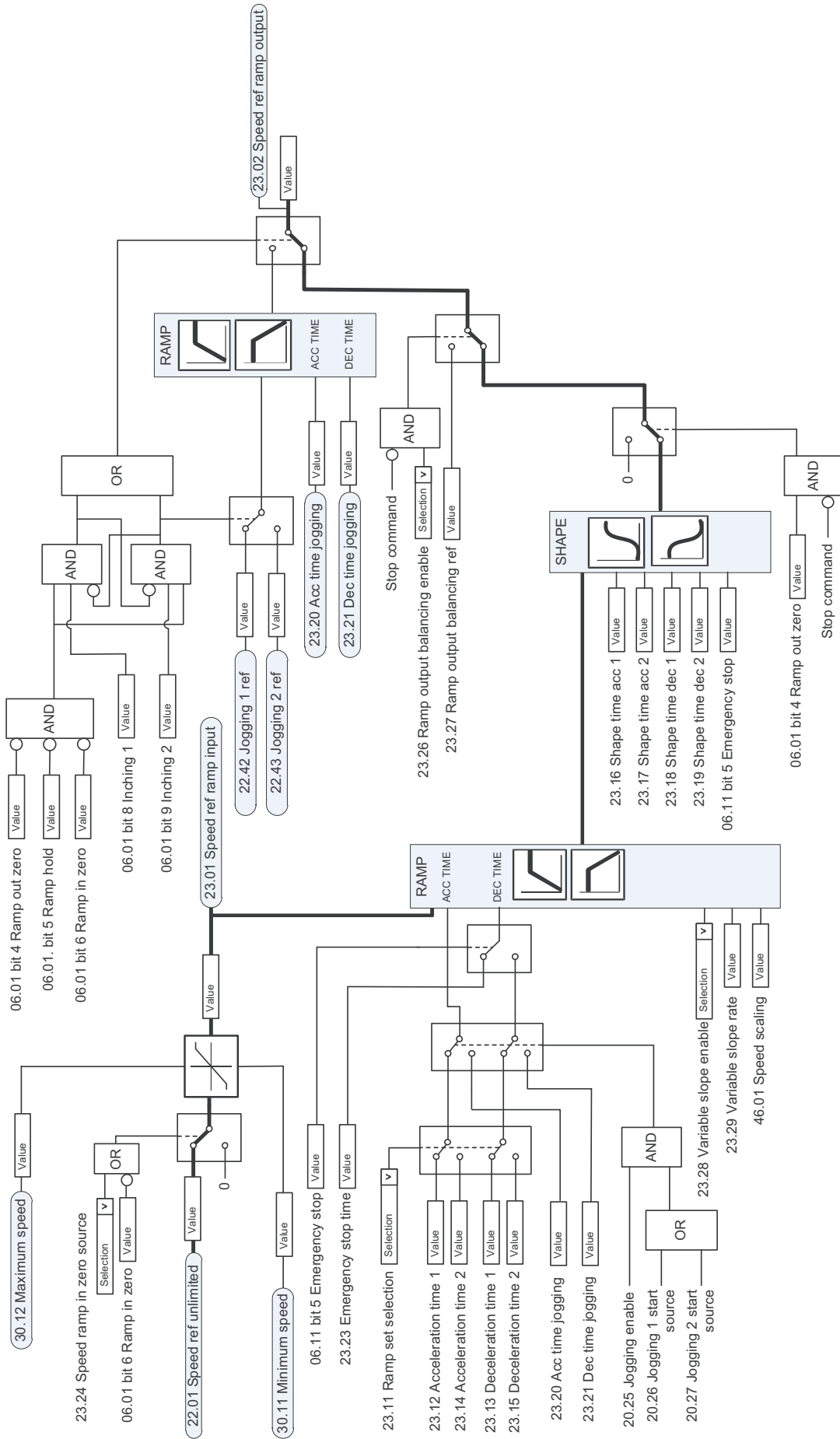

Motor feedback configuration

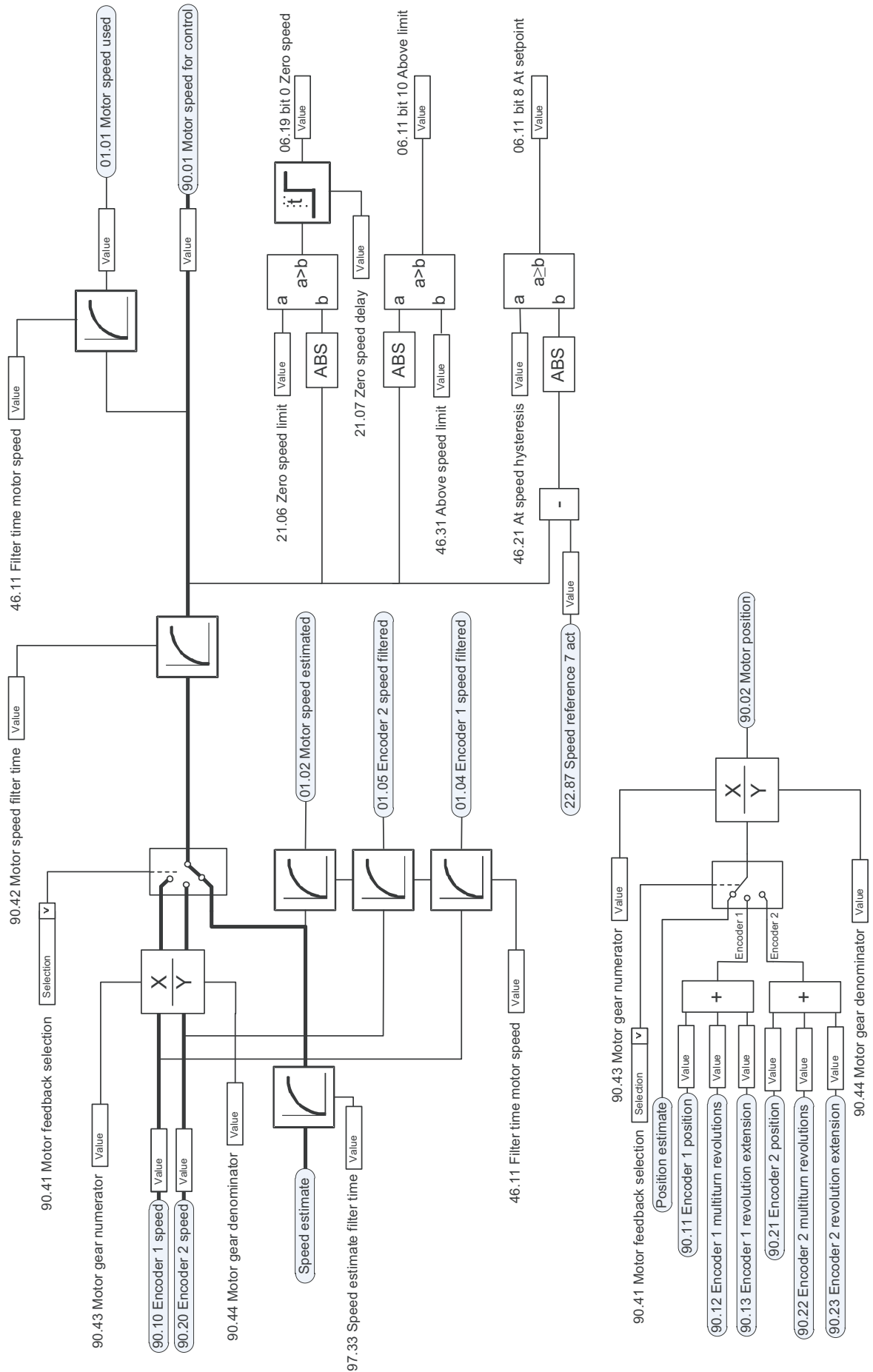

Load feedback and position counter configuration

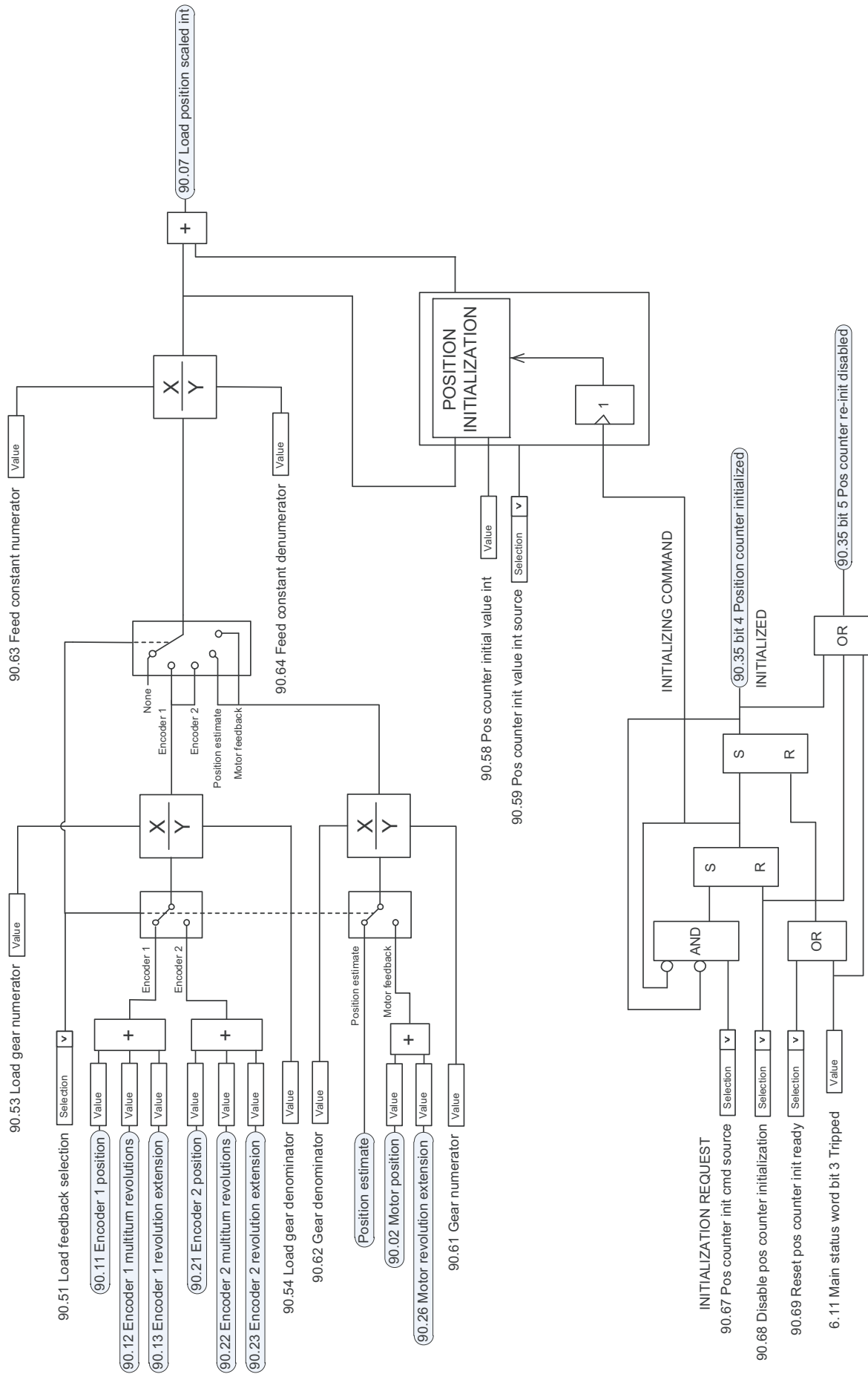

Speed error calculation

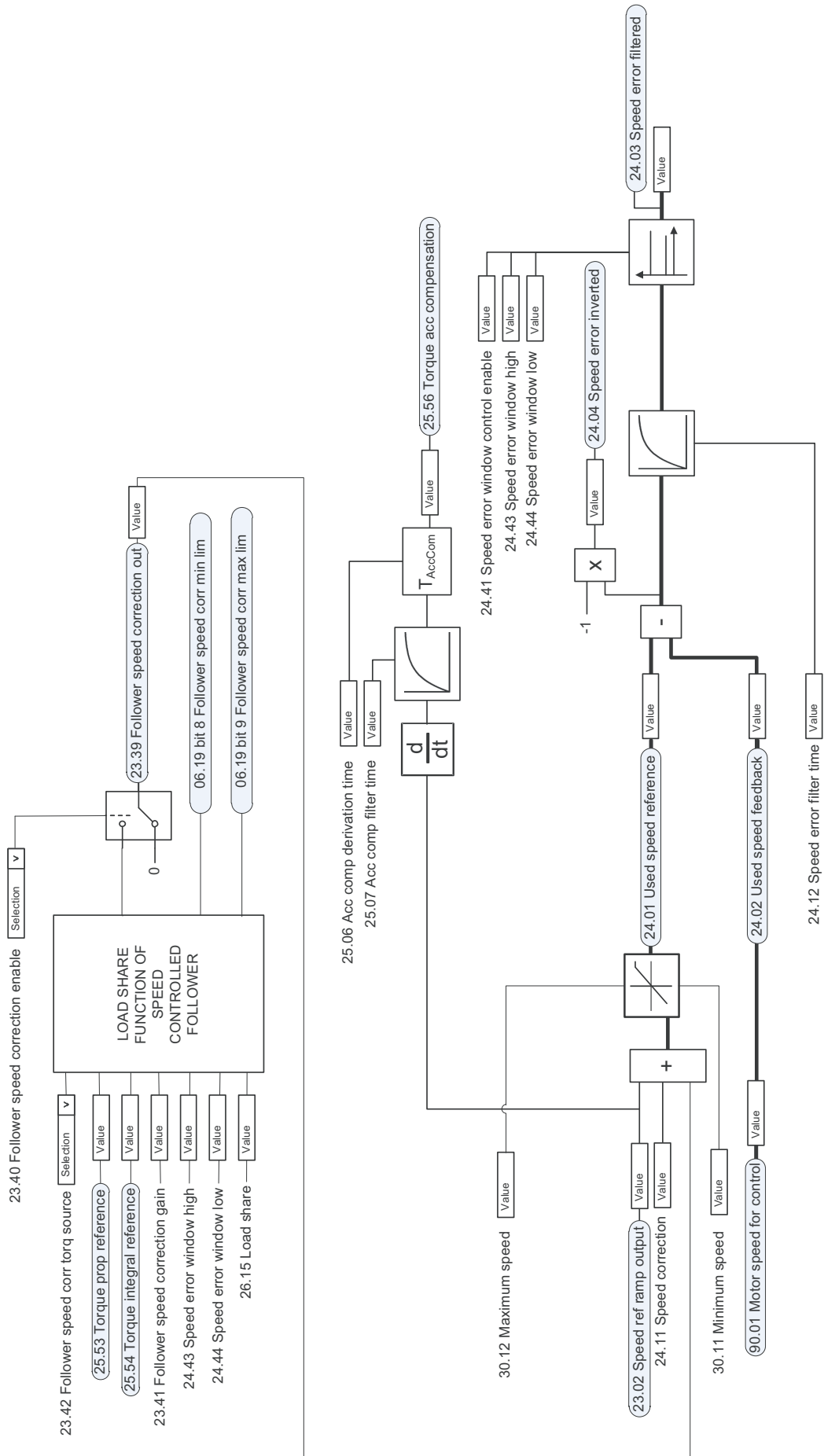

Speed controller

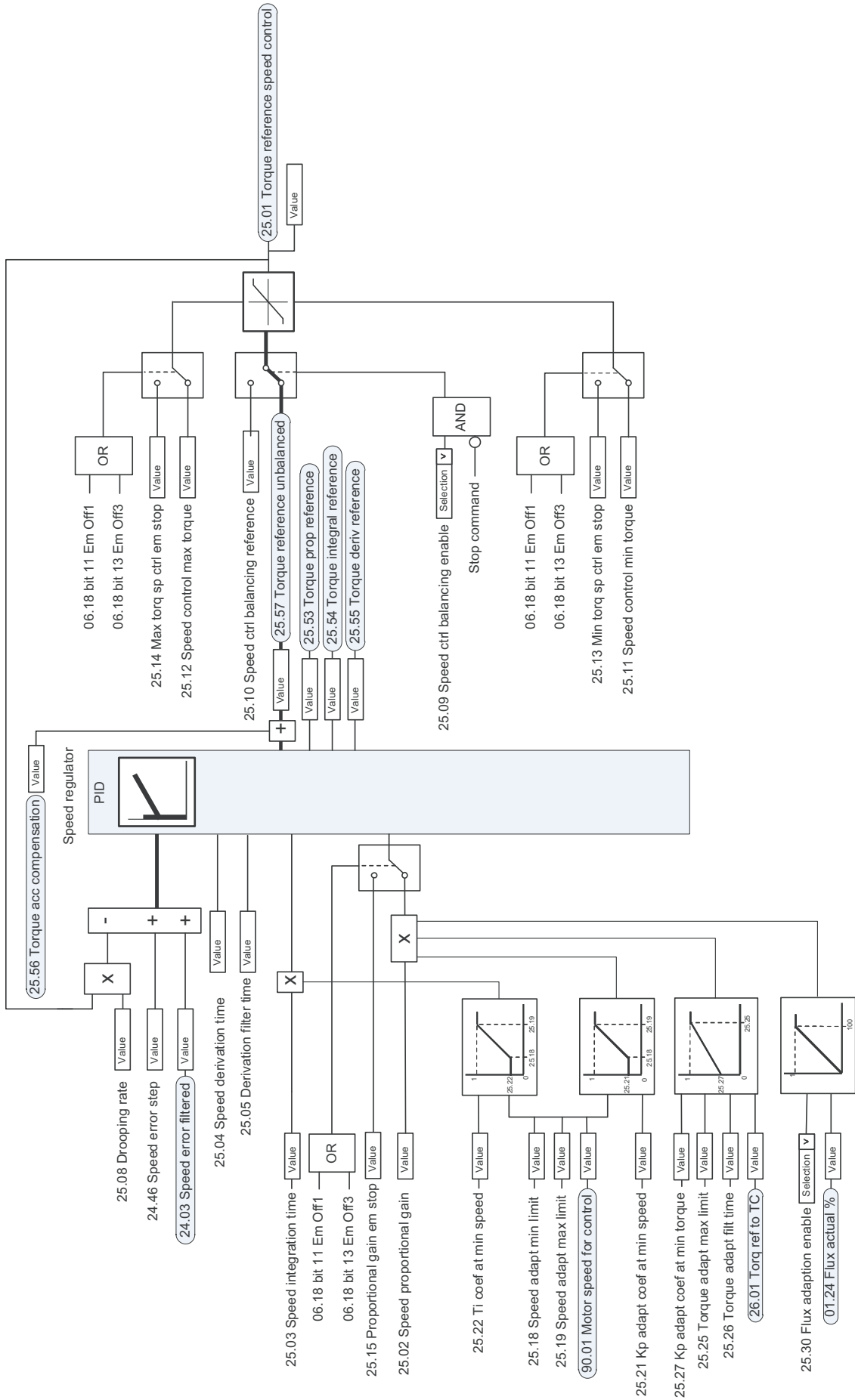

Torque reference source selection and modification

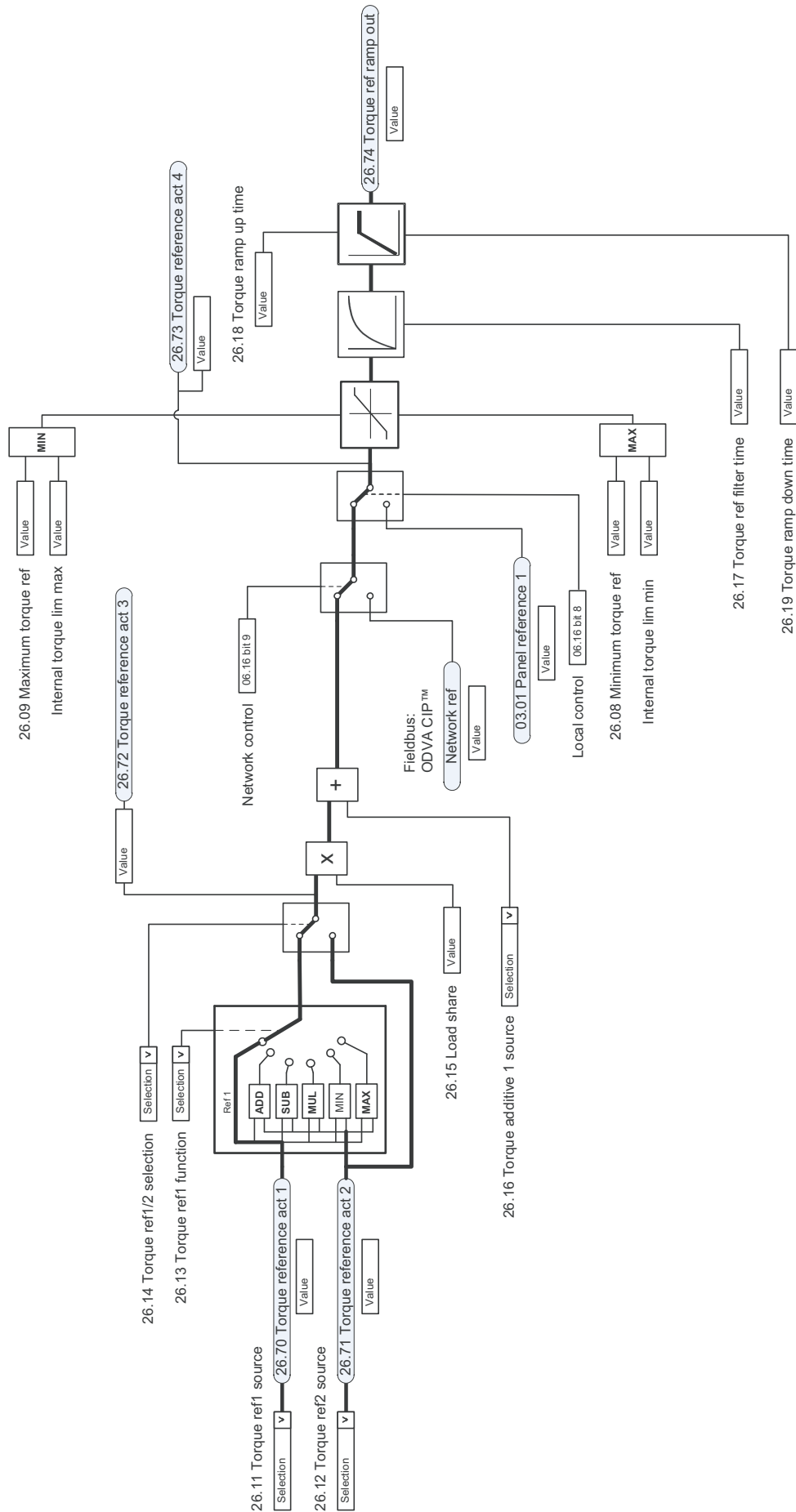

Operating mode selection

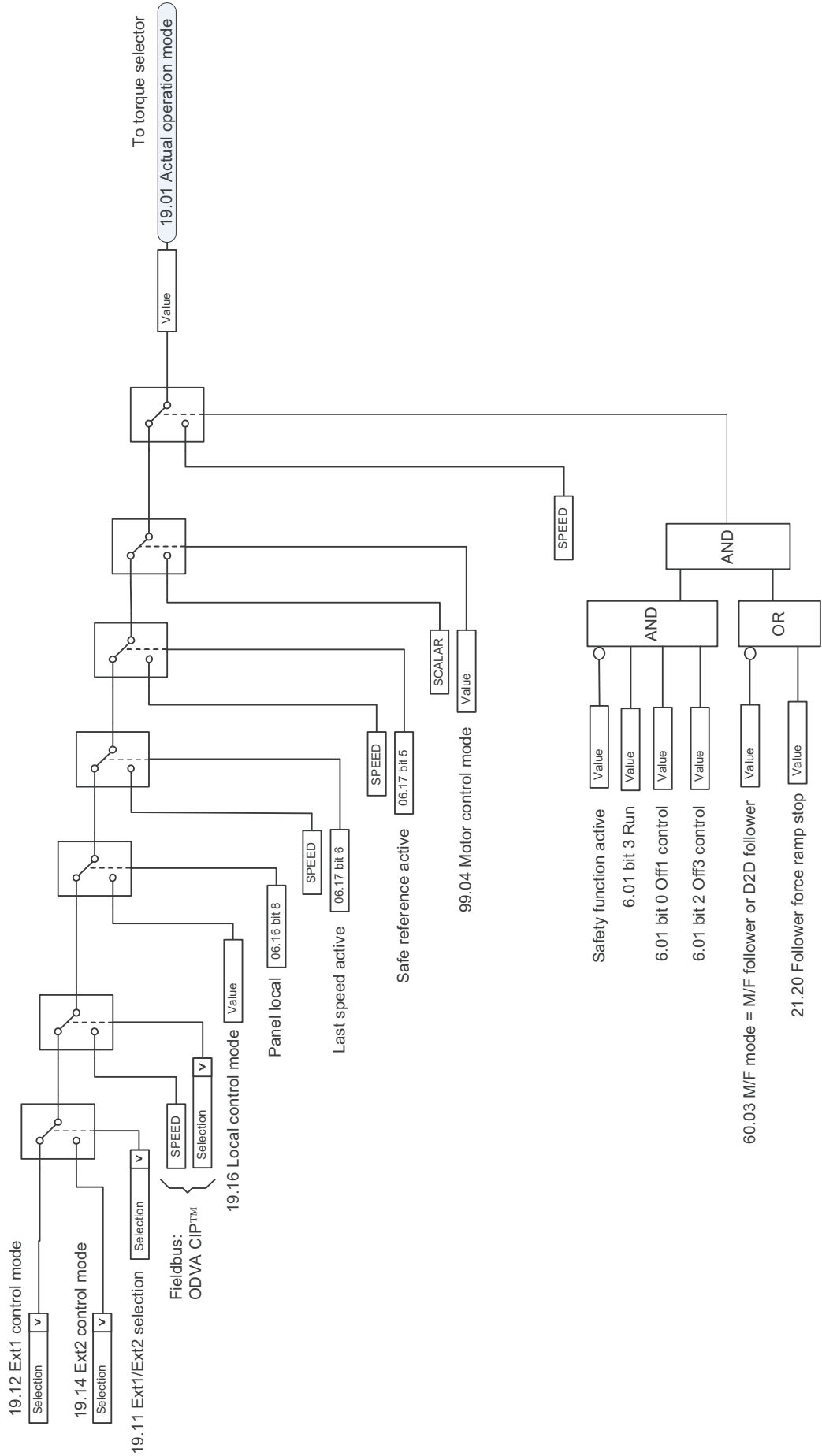

Reference selection for torque controller

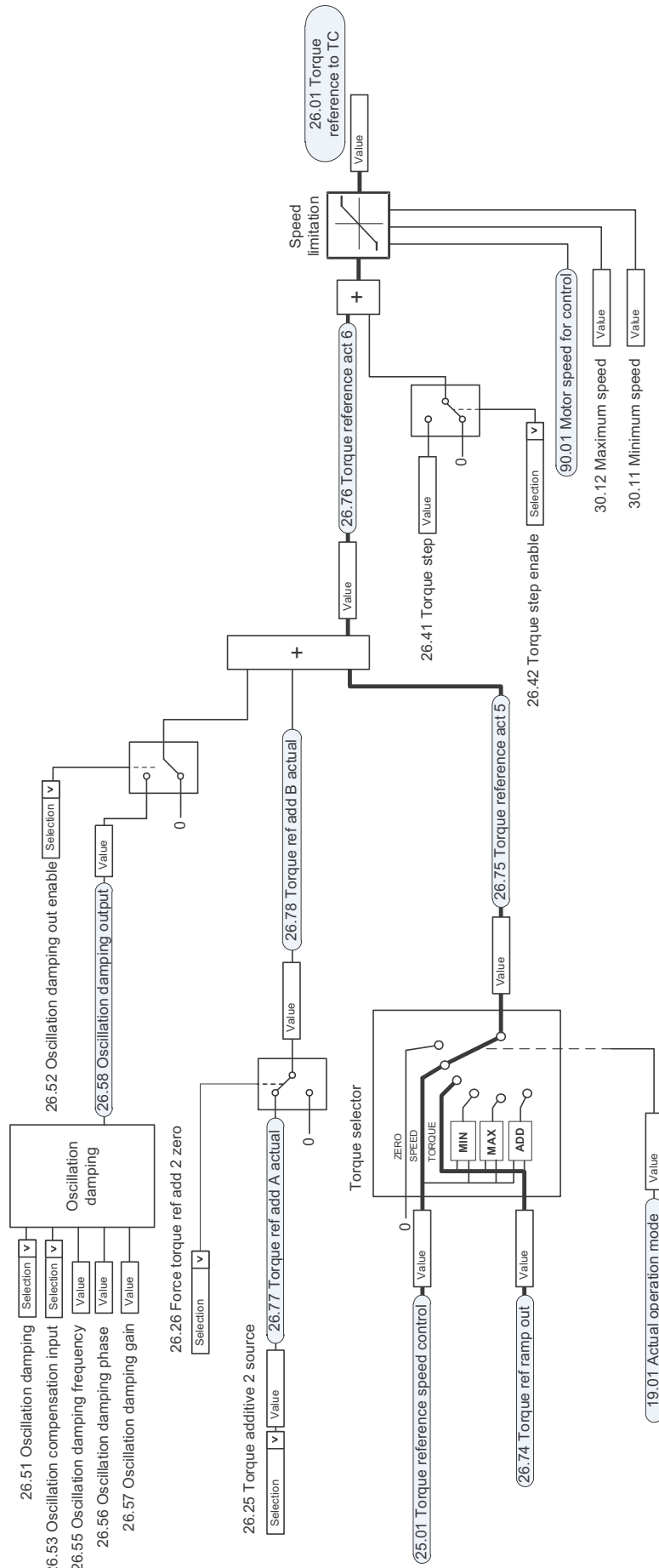

Torque limitation

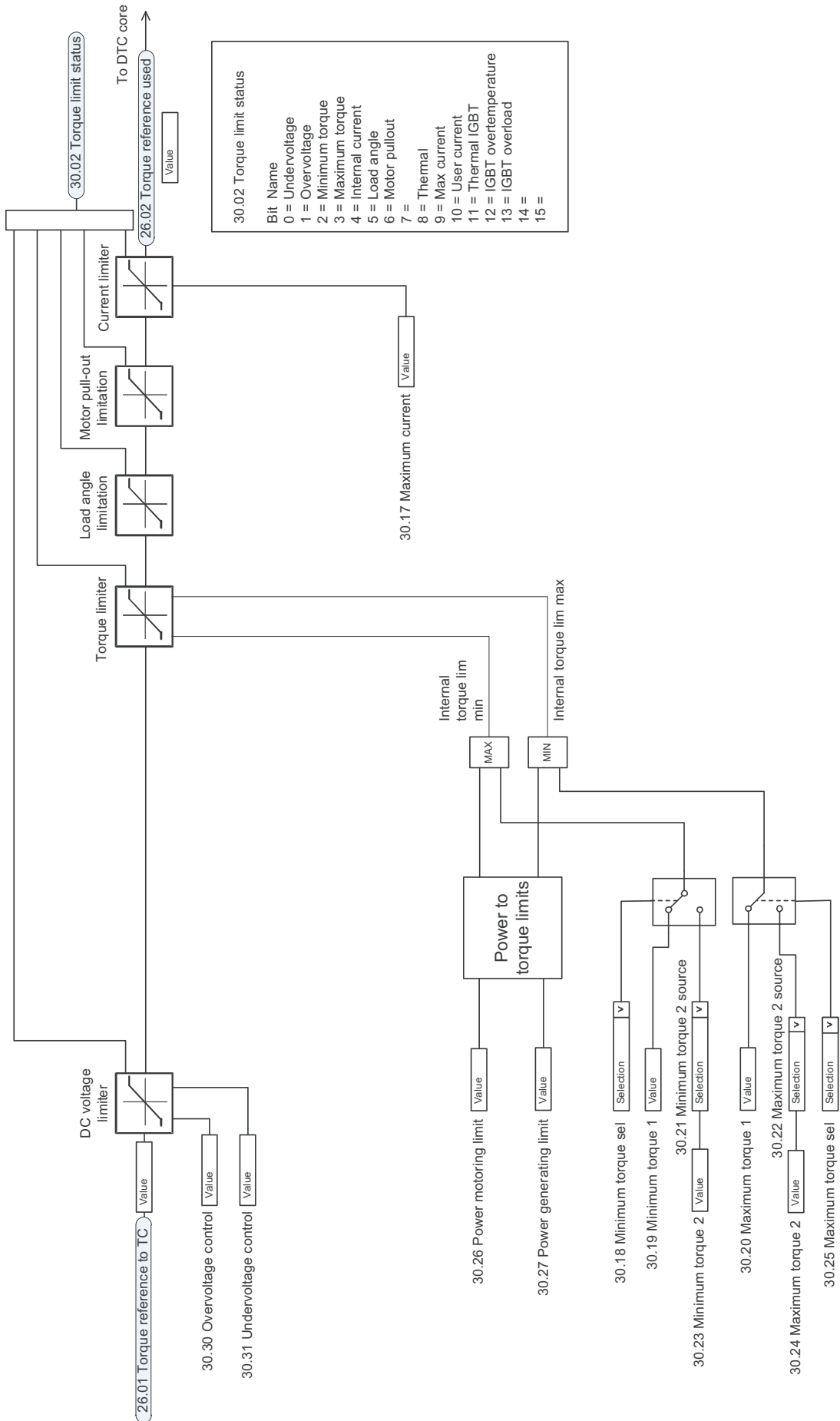

Torque controller

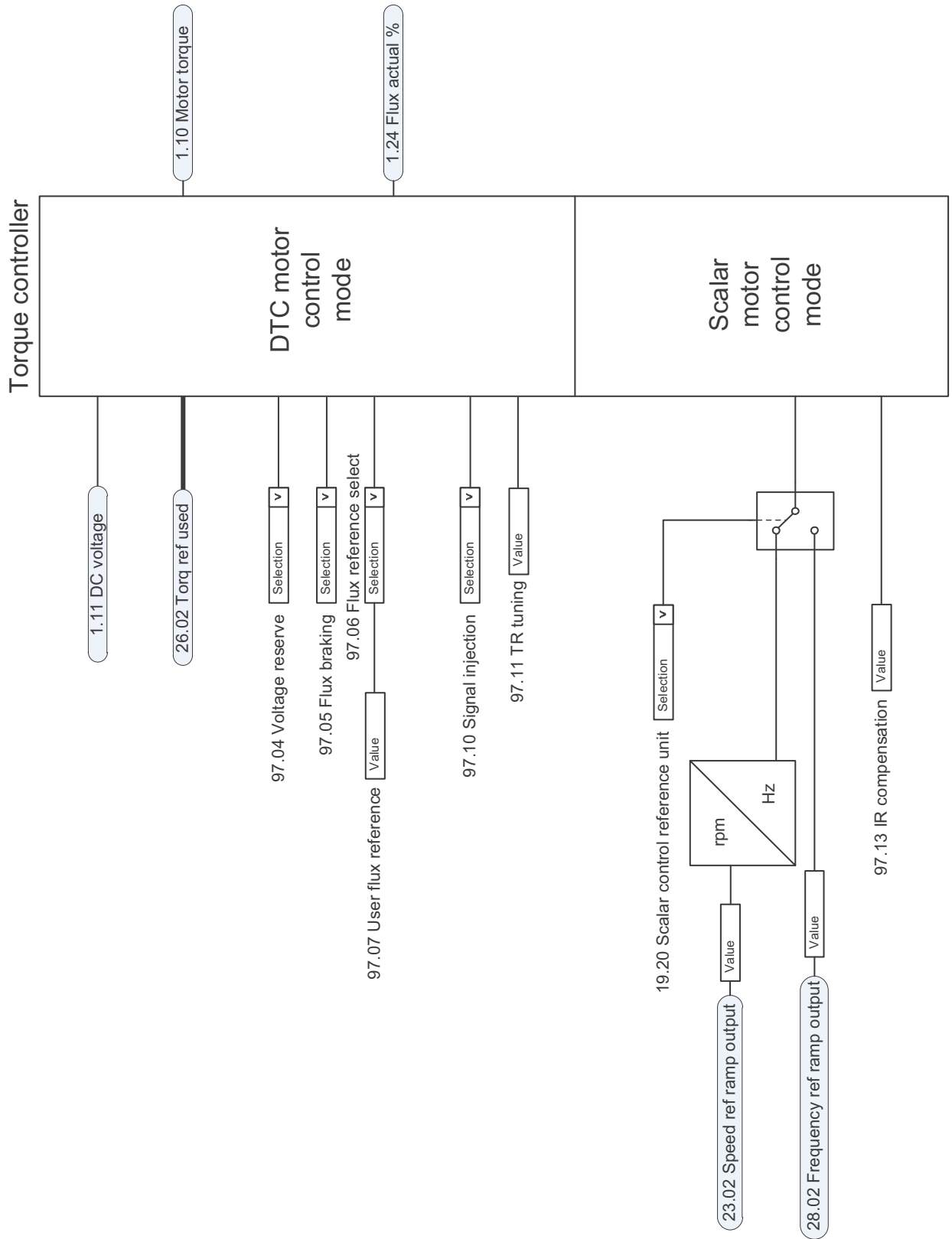

Frequency reference selection

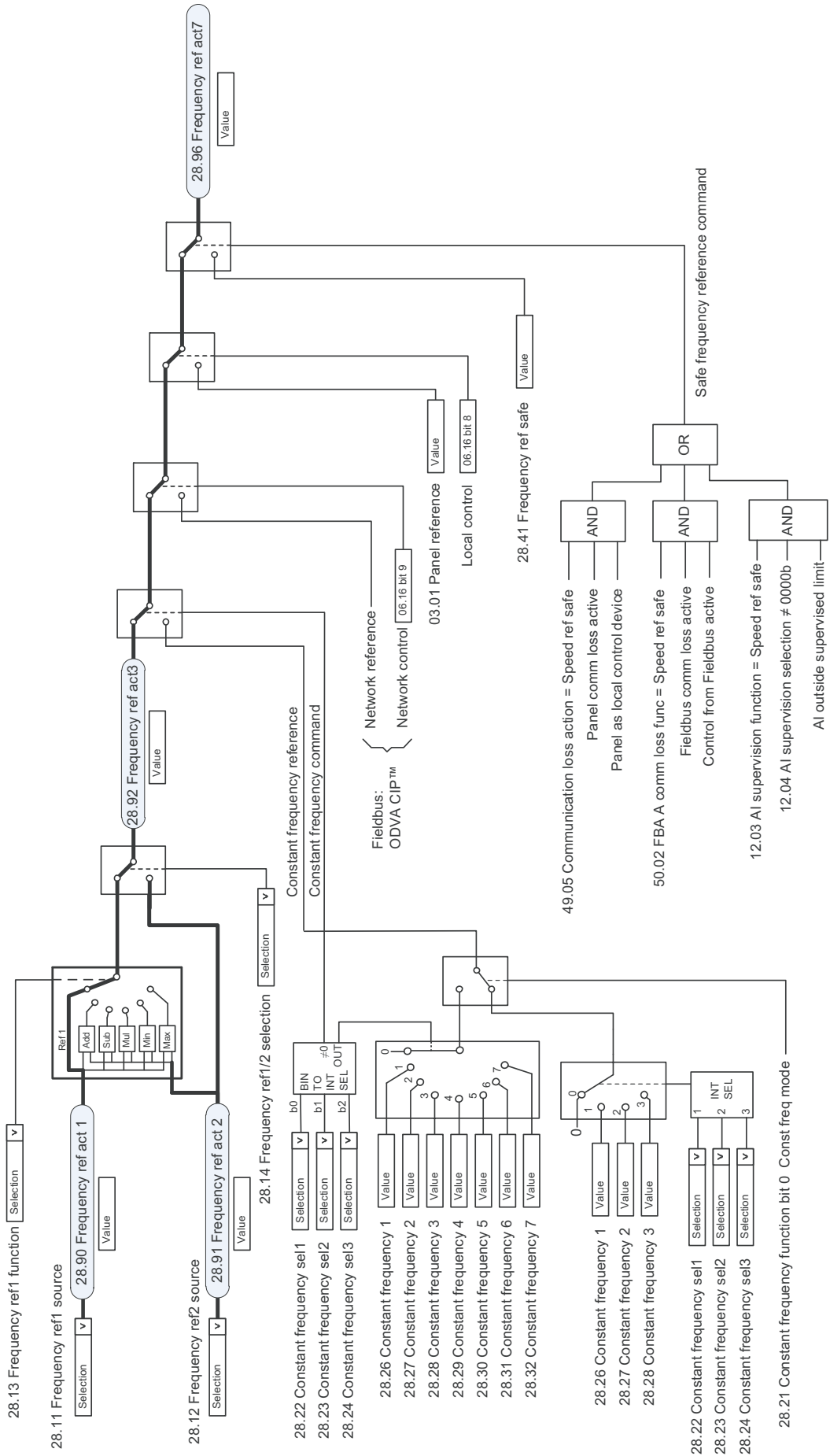

Frequency reference modification

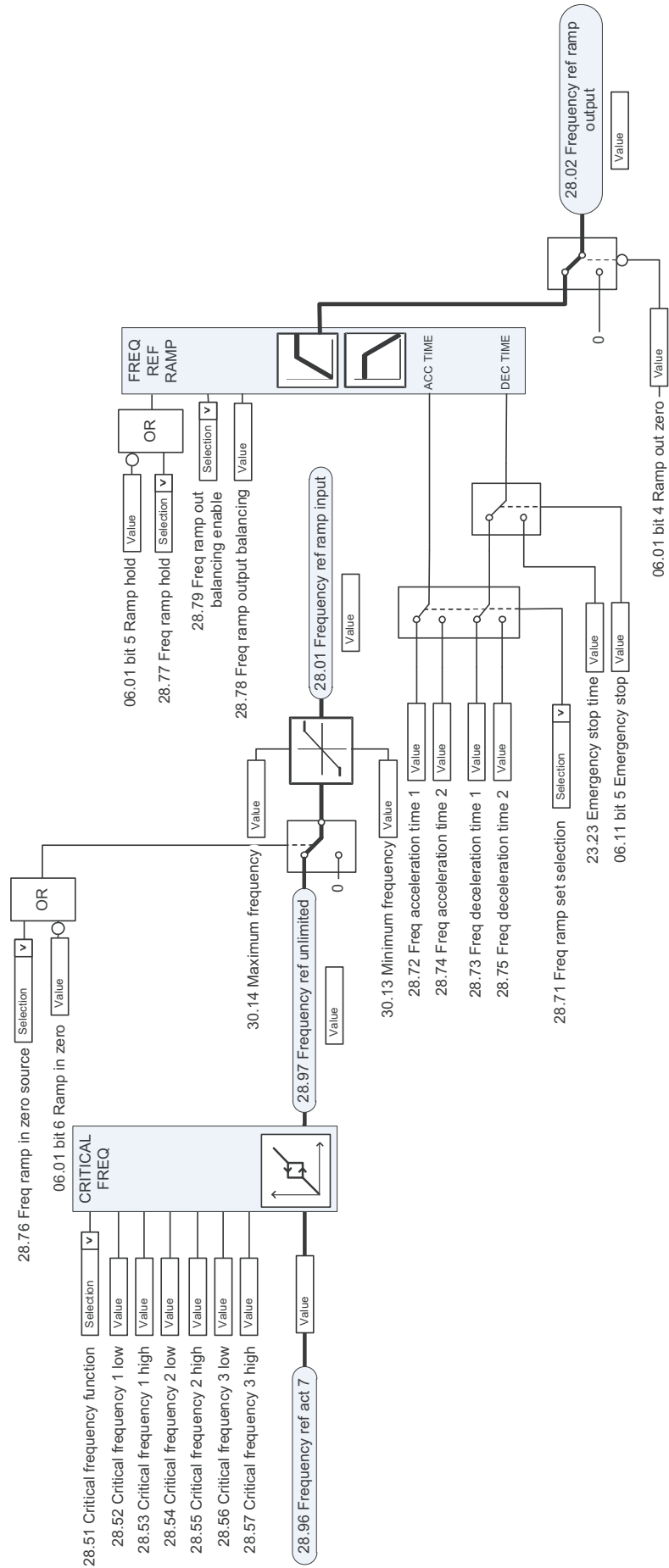

Master/Follower communication I (Master)

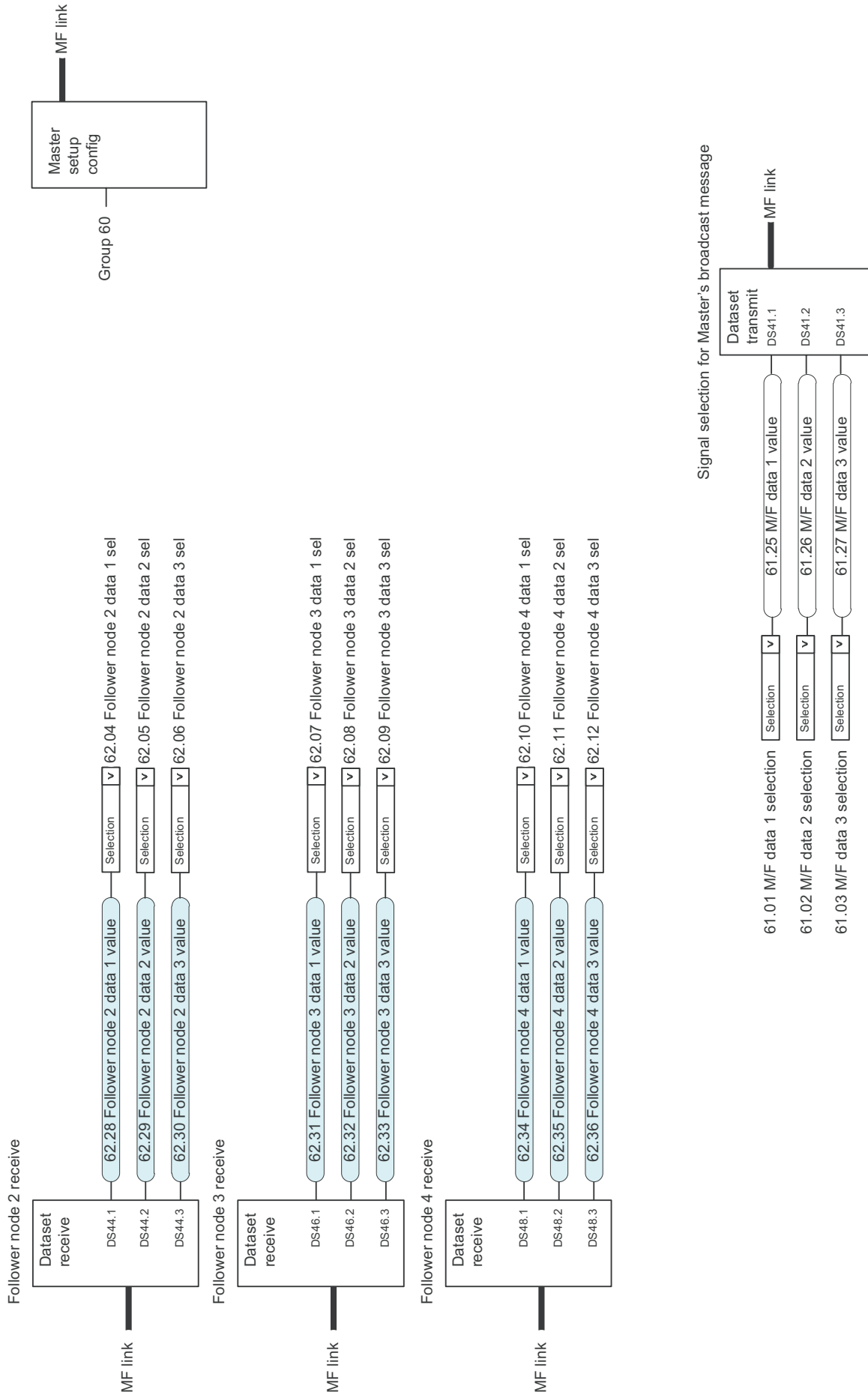

Master/Follower communication II (Follower)

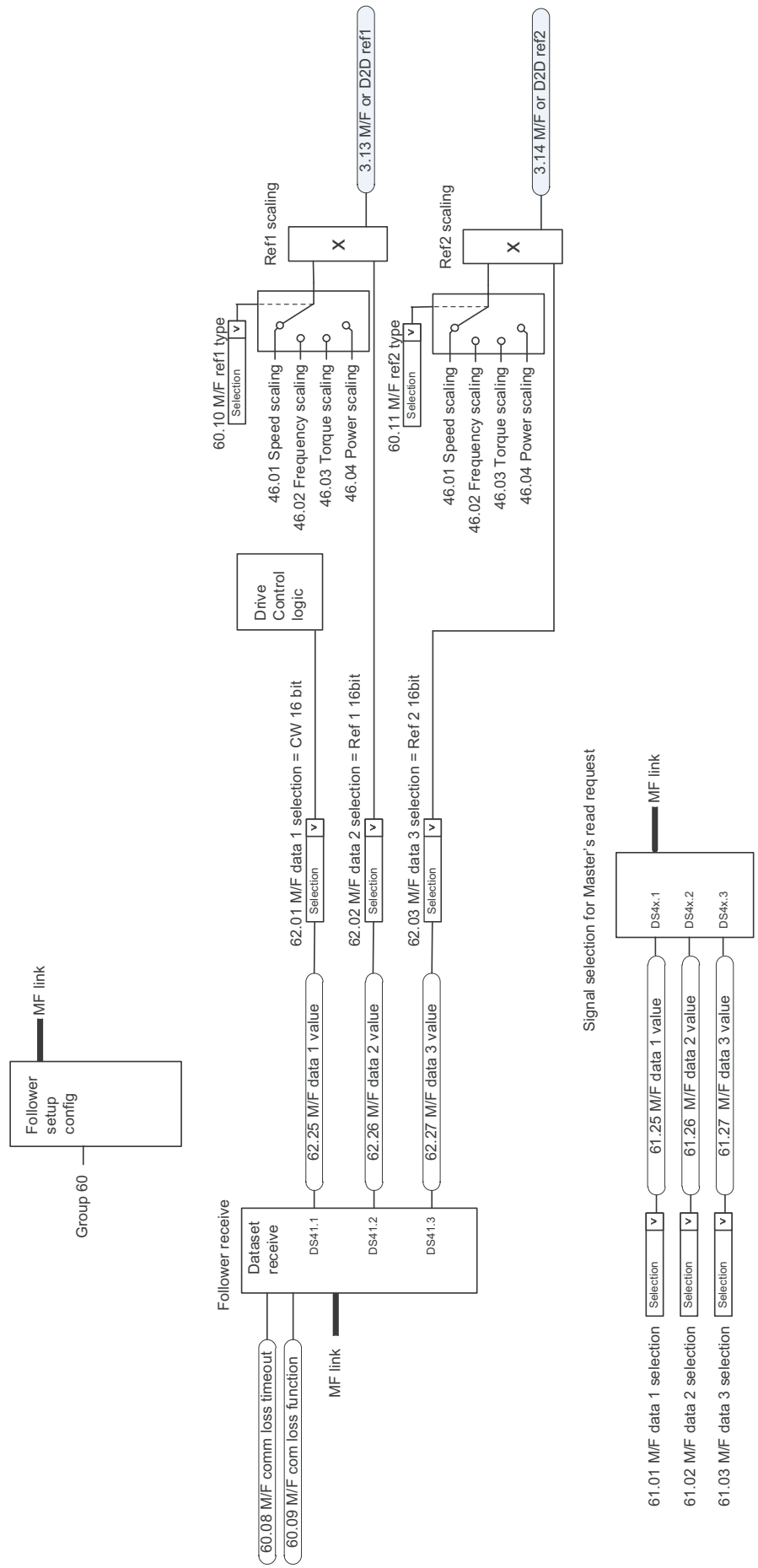

Further information

Product and service inquiries

Address any inquiries about the product to your local ABB representative, quoting the type designation and serial number of the unit in question. A listing of ABB sales, support and service contacts can be found by navigating to www.abb.com/searchchannels.

Product training

For information on ABB product training, navigate to new.abb.com/service/training.

Providing feedback on ABB Drives manuals

Your comments on our manuals are welcome. Navigate to new.abb.com/drives/manuals-feedback-form.

Document library on the Internet

You can find manuals and other product documents in PDF format on the Internet at www.abb.com/drives/documents.

Contact us

www.abb.com/drives

www.abb.com/drivespartners

3AXD50000030629 Rev A (EN) EFFECTIVE: 2016-04-11